

USER'S MANUAL

CTL-4100WL



[About Wacom Intuos](#)
[Features of your Wacom Intuos](#)
[Set up your device](#)
[Getting started with your pen tablet](#)
[Connect wirelessly by Bluetooth](#)
[Work with your pen](#)
[Customize your device in Wacom Tablet Properties](#)
[Use On-Screen Controls as shortcuts](#)
[Access application-specific settings](#)
[Wacom Desktop Center](#)
[Map your device to your monitor](#)
[Care for your device](#)
[Technical Support](#)



wacom®

Table of Contents

Table of Contents	2
About Wacom Intuos	5
Included with your Wacom Intuos	5
Features of your Wacom Intuos	6
Set up your device	7
Set up your work area	8
Install the driver	9
Update the driver and firmware	9
Get started with your pen tablet	10
Access user help	10
Connect wirelessly by Bluetooth	11
Tips for improving Bluetooth connectivity	11
Waking your pen tablet	11
Connecting wirelessly to a second computer	11
What the LED means	12
Work with your pen	13
Personalize your pen with a color ring	13
Specialty pens	13
Use your pen	14
Pen tip and eraser	14
Pen buttons	14
Store your pen	15
Customize your pen functions	16
Assign settings to the pen button and pen tip	16
Customize other pen properties	16
Tips:	17
Replace the pen nib	18
Use your pen with Windows Ink	19
Advanced pen and eraser	20
Customize your device in Wacom Tablet Properties	21
What can I customize in Wacom Tablet Properties?	21
Where can I access settings and other options in Wacom Tablet Properties?	21
Open Wacom Tablet Properties	22
Assign settings in Wacom Tablet Properties	23
Example of assigning a setting in Wacom Tablet Properties	24
What settings can I assign?	25
Assign keystrokes	29
ExpressKeys™	30
Tips	30

Express View	32
Customize user options	33
Use On-Screen Controls as shortcuts	34
How to create and use an On-Screen Control	34
On-Screen Control layouts	34
Create On-Screen Controls	35
Assign settings to Radial Menus and Screen Keys	37
Assign settings to Keypads	38
Assign On-Screen Controls	39
Access application-specific settings	40
Application-specific settings assigned by you	41
Settings assigned by applications	43
How do I know what setting is assigned?	43
Settings assignments work differently for different customizable components	43
Imported settings assigned by applications	44
Wacom Desktop Center	45
Customizing your device	45
Running the Setup Wizard	45
Redeeming Software	45
Backing up your settings	45
Backing up your files	46
Updating your tablet	46
Getting apps and products	46
Getting Support for Wacom products	46
Logging in with your Wacom ID	46
Map your device to your monitor	47
Map your device in pen mode	48
Map your device in mouse mode	50
Tablet active area mapping	51
How does the tablet active area correspond to your monitors?	51
How does pen movement on the device correspond to what you see on the monitor?	51
Tips for working in the tablet active area	51
Switch between displays using Display Toggle	52
Care for your device	53
Technical Support	54
Test the tablet	55
Test the ExpressKeys™ and Touch Ring	56
Testing the ExpressKeys™	56
Testing the Touch Ring	56
Test the pen	58
Diagnose issues using Wacom Tablet Properties	58

Glossary	60
Order parts and accessories	62
Privacy	63
Trademarks	64



About Wacom Intuos

Your Wacom Intuos™ pen tablet gives you a variety of ways to express yourself creatively.

Please see the printed Quick Start Guide that came with your pen tablet for set-up instructions and [driver installation](#).

The [Wacom Intuos features](#) topic gives a more detailed description of your Wacom Intuos, including illustrations of your pen and tablet.

The product Help topics listed in the Table of Contents on the left of this page will help you make the best use of your Wacom Intuos.

To view additional options for using your pen tablet, see [Getting Started](#).

Included with your Wacom Intuos

When you have unpacked your Wacom Intuos, make sure that you have received the following items:

- Wacom Intuos tablet
- Wacom Pen 4K
- Quick Start Guide (booklet)
- Regulatory statement (booklet)
- USB cable

There are also spare nibs and a nib removal tool inside your pen. See [Wacom Intuos features](#) for more information.

Your Wacom Intuos can only be used with the pen that came with your product, or with a Wacom accessory pen or tool specified for use with this version of Wacom Intuos.

The Important Product Information, which describes safety precautions, specifications, warranties, and the license agreement for your device, can be found in the [Wacom Desktop Center](#).

Features of your Wacom Intuos

The features of your Intuos pen tablet include:

- **Micro USB port:** Connects your Intuos to your computer. See the Quick Start Guide that came with your Intuos for instructions on connecting it to your computer. Also see [About your Intuos](#).
- **Customizable ExpressKeys™:** Four keys across the top of the Intuos allow you to set frequently used functions or keystrokes, or to simulate button clicks or modifier keys.
- **Power / Bluetooth button:** Only present on Wireless versions of Intuos, this button turns the tablet on and off as well as being used to connect wirelessly to a computer.
- **Power LED:** Lights when the Intuos is connected to an active USB port. For Bluetooth wireless Intuos versions, this light will be active when paired or connecting to a computer. When connected via USB the light will be white at full charge and orange when charging.
- **Active area:** Patterned area of the Intuos surface that detects pen input.

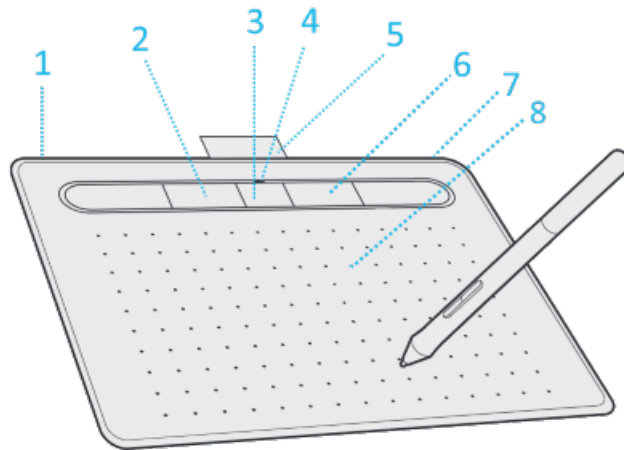

Number	Item
1	Micro USB port (rear corner)
2	ExpressKeys™
3	Power / Bluetooth button (only Bluetooth models)
4	Power LED
5	Pen holder (for transport)
6	Pen tray (for storage)
7	Pen tether hole
8	Active area

Set up your device

1. First, follow the directions in this section of user help. The Quick Start Guide included in the box contains images that can help.
 - Attach any stands that are included with your device.
 - Set up your work area.
2. After you set up your device, follow the directions in the **Get started** section of this user help so you can start using your device.
 - Connect your device to your computer.
 - Install the driver.

Set up your work area

- Position your tablet, pen, and keyboard for easy access.
- Adjust your monitor so you can view it comfortably without eyestrain, placing it about one arm's length away from you.
- Position the tablet so the screen cursor follows the same direction as your hand movements on the tablet.
- If you are using the tablet as a creative tool, consider placing the tablet below the keyboard and centered below your monitor.

Install the driver

Important: You must install the driver for your device to work properly, unless your device comes with a pre-installed driver. Refer to the Quick Start Guide to discover if your device has a pre-installed driver or not.

1. Go to the Wacom [drivers page](#).
2. Click **Download** next to the latest driver that corresponds to your computer's operating system.
3. Follow the prompts to finish the driver installation.

Update the driver and firmware

Updated drivers and firmware are available on the [Wacom Desktop Center](#) and at the Wacom [drivers page](#) periodically. Check in and update regularly so that your device has the latest features and functionality.

- From the Wacom Desktop Center, select **Updates**, and then click the update to install it.
- If the Wacom Desktop Center is not available for your device, go to the Wacom [drivers page](#) to find the latest updates.

Note: Your device will not work if you uninstall the driver. If you uninstall the driver, reinstall the latest driver from the [drivers page](#) so that your device works again. If the driver is reinstalled, your device will revert to default settings.

Get started with your pen tablet

The Quick Start Guide included in the box with your device contains images that can help you to set up your pen tablet.

1. Connect your device to your computer.
2. [Install the driver](#) software on your computer.

Access user help

You can access user help topics directly from [Wacom Tablet Properties](#). When you click the ? icon, you are directed to a help topic about the feature you are currently using.

You can also open user help from the [Wacom Desktop Center Help](#) menu.

Notes

- User help is common to Windows and Mac computers. Screenshots are from a Windows computer, unless otherwise noted.
- Information about your specific computer hardware, operating system, and application software is not included. Refer to the product information provided with those products.

Connect wirelessly by Bluetooth

You can work wirelessly by pairing your tablet to a computer by Bluetooth. Your tablet is battery-powered when you are connected by Bluetooth.

1. If your tablet is connected to your computer by USB, disconnect the USB cable.
2. Open your computer's Bluetooth menu and turn on Bluetooth.
3. Press the power button on your tablet until the blue LED starts to blink.
4. If your computer was previously connected to a computer which is now off or out of range, the blue LED above the power button will blink quickly for 15 seconds.
5. The blue LED slowly blinking indicates the tablet is discoverable by Bluetooth.
6. In your computer's Bluetooth menu, select your tablet's name when it appears.
7. Click **Pair** or complete the pairing process per your operating system's instructions.
8. The blue LED will stop blinking when your tablet is connected.
9. Close the Bluetooth menu.

After you pair your computer to your tablet, you can switch between a Bluetooth and USB connection by plugging and unplugging the USB cable.

Tips for improving Bluetooth connectivity

- Check to see if your computer has a built-in Bluetooth antenna. If not, purchase and install a Bluetooth adapter.
- Check what version of Bluetooth your computer or adapter is using. If you are not using a compatible version, install a compatible Bluetooth adapter.
 - Version 4.0 or higher is recommended.
 - A minimum of Version 2.1 is required.
- Check **Updates** in the [Wacom Desktop Center](#) to make sure that you are using the latest driver.
- Update your operating system to the latest version.
- Move your tablet closer to your computer, and make sure that the space between the computer and the tablet is clear.
- Unpair other Bluetooth devices, especially any that transfer a large amount of data, such as headphones, speakers, or storage devices.

Waking your pen tablet

When not used for 30 minutes your pen tablet will automatically turn off to preserve battery charge and extend battery life.

To wake your Intuos:

- Press the power button.
- The blue LED will quickly blink while reconnecting with your computer.
- The blue LED will stop blinking when the connection has been restored.

Connecting wirelessly to a second computer

1. If the first computer is on and within range of the tablet:
 1. Unpair your pen tablet from your first computer in the computer's Bluetooth menu.
 2. The LED on the pen tablet will turn off to indicate the connection has been lost.
2. Confirm the [driver is installed](#) on your second computer.

3. Repeat the connection steps at the beginning of this page with your second computer.

What the LED means

Quite a bit of information is conveyed by the status and color of the LED:

LED Color	Meaning
Off	If connected to a wall adapter by USB cable this indicates the battery is fully charged. Otherwise, it means the tablet is off.
White	Connected to computer by USB cable, battery fully charged
Blue (not blinking)	Connected to computer by Bluetooth
Blue (slowly blinking)	In pairing mode, attempting to connect to computer
Blue (quickly blinking)	Attempting to reconnect to last paired computer
Orange (not blinking)	Connected to computer or wall adapter by USB cable, battery charging (> 10%)
Orange (blinking)	Battery is low (<= 10%) and connected by Bluetooth, attach to a computer or wall adapter by USB cable to charge

Work with your pen

All pen tablets and pen displays include a cordless, battery-free pen that you use to interact with your device. You can hold, write, and draw as you normally would with a pen or pencil.

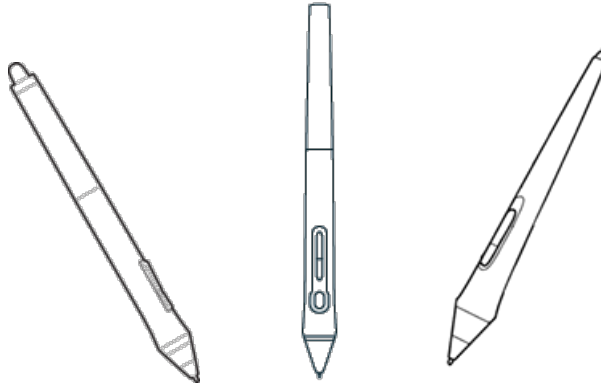

Pen styles vary depending on the pen tablet or pen display that you purchased.

Personalize your pen with a color ring

If your pen includes color rings, you can use them to identify and personalize your pen.

1. Unscrew the cone near the pen tip.
2. Remove the color ring that is already on the pen and slide on your preferred color ring.
3. Replace the cone.

Specialty pens

Pens designed for more advanced work, such as the Wacom Pro Pen 3D, Art Pen, or Airbrush, can be used with many pen tablets and pen displays.

To discover other pens and tools that can be used with your pen tablet or pen display, go to the [Wacom Store](#).

Use your pen

Use your pen to interact with your device. This includes to drawing, writing, or moving items, and activating settings that you assign to pen buttons.

Tips:

- Hold the pen as you would normally hold a pen or pencil. Adjust your grip so that you can press any pen buttons easily with your thumb (recommended) or index finger without accidentally pressing it.
- To make it easier to access tools in applications like Adobe Photoshop, assign modifiers, such as Alt and Ctrl, to your pen buttons so that you do not have to use your keyboard keys.

 **Important:** You can customize [user options](#) that change the way your pen works with your device. Try both **Side Switch modes** to see which works best for you.

Pen tip and eraser

- **Draw or sign:** Draw or sign with the pen tip directly on the device surface.
 - Pens are pressure-sensitive, so the harder you press, the thicker your lines and the denser the color.
- **Move the cursor:** Move the pen while holding it slightly above the device without touching the screen surface.
- **Double-click:** Quickly tap the screen twice in the same place with the pen tip.
- **Erase:** Flip the pen to the side opposite the pen tip and move the eraser over the area you want to erase, just as you would use the eraser on a pencil.
 - **Note:** Some pens do not have an eraser.
- **Select an item:** Tap the screen once with the pen tip.
- **Move an item:** Select the item with the pen tip, then slide the pen tip across the screen to move it.

Pen buttons

Use pen buttons as shortcuts to [settings](#). You can view and change the assigned settings on the **Pen** tab in [Wacom Tablet Properties](#).

- **Note:** Some pens do not have any buttons.

You activate settings differently depending on your [Side Switch mode](#).

- If your [Side Switch mode](#) is **Hover Click**, then hold the pen tip slightly above the surface of your device and press the button.
- If your [Side Switch mode](#) is **Click & Tap**, then touch the device surface and press the pen button.

If your pen has a long, thin button, press the upper part of the button for one setting and the lower part for another.

Store your pen

Store your pen properly keep it in good condition and help the pen tip last longer.

⚠ Important: Store your pen so there is no pressure on the pen tip or eraser.

- If your device has a pen stand, store the pen with the tip down in the stand.
- If your device included a pen case, store the pen in the pen case.
- If your device has a pen sleeve, holder, or tray, the pen can be stored there.

Tip: Do not leave the pen on the device when you are not using the pen. This might cause issues when you are using a mouse and might prevent your computer from going to sleep.

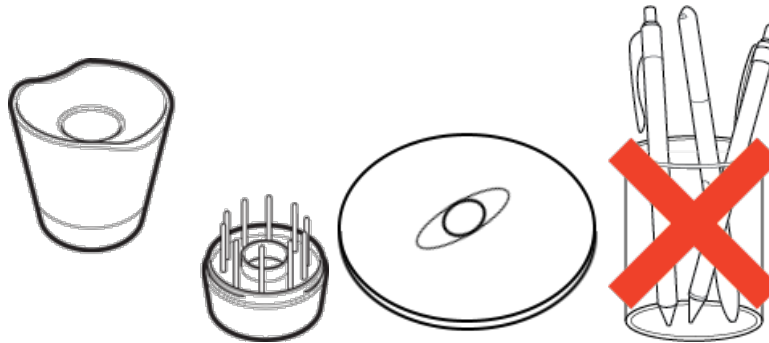

Pen stands vary depending on the pen tablet or pen display that you purchased.

Customize your pen functions

Customize how your pen works by assigning settings to pen buttons, adjusting the pen tip feel and pressure, and selecting the way you want to right-click with the pen.

Note: Some pens do not have an eraser or buttons.

Assign settings to the pen button and pen tip

1. [Open Wacom Tablet Properties](#).
 - **Important:** The options available in Wacom Tablet Properties will vary depending on your device.
2. If there is a **Tool** row, select your pen.
3. Select the **Pen** tab.
4. For each of the pen buttons, select the setting you want from the drop-down menu next to the pen.
5. For the pen tip, double-click the pen tip in the image to display a drop-down menu. Then, select a setting for the pen to perform when you tap the tablet surface with it.

⚠ WARNING: The tip must be set to **Click** in order to draw for most graphics applications.

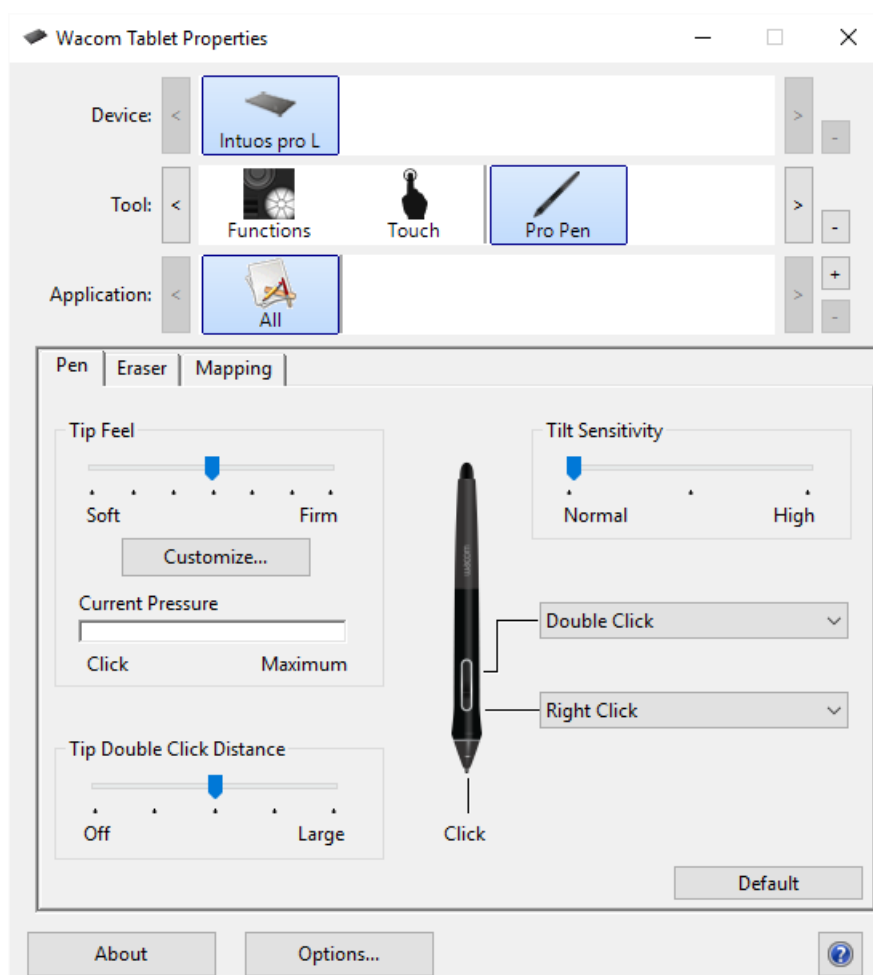

The above screenshot is for descriptive purposes, it may not match your screen.

Customize other pen properties

- **Tip Double Click Distance:** To change the distance between your pen and the tablet surface during a double-click, move the slider.
- **Current Pressure:** To see how hard you need to press with the pen, check your Current Pressure by pressing down with the pen tip or eraser in an empty area of the Wacom Tablet Properties window.
 - If you want to change the amount of pressure you need to use the pen tip or eraser, move the **Tip Feel** and **Eraser Feel** sliders.
- **Options:** To select the way you right-click with the pen, click Options and select a different **Side Switch Mode**.
- **Tilt Sensitivity:** To change how much the tilt of your hand affects your pen strokes, drag the slider. Open an application that supports tilt to test while you are adjusting, so you can see how your changes affect your strokes.
- **Pen Feel Details:** To change the tip sensitivity, click **Customize** and adjust advanced pen and eraser options.

Tips:

- Set the pen tip to **Click** and one of the pen buttons to **Double-Click**.
- If you want a narrower range of pressure values in a pressure-sensitive application, select a soft **Tip Feel**.
- If the pen overreacts to slight pressure, try a firmer **Tip Feel** setting.
- If you notice a delay at the beginning of brush strokes, inking strokes, or drag actions, try a smaller **Tip Double Click Distance** or set a pen button to double-click instead of the pen tip.
- You can return the pen to default settings by going to the **Pen** tab in [Wacom Tablet Properties](#) and clicking **Default**.

Replace the pen nib

Extra pen nibs and a nib removal tool are provided in the end of the pen. Refer to the illustrations below for more detail:

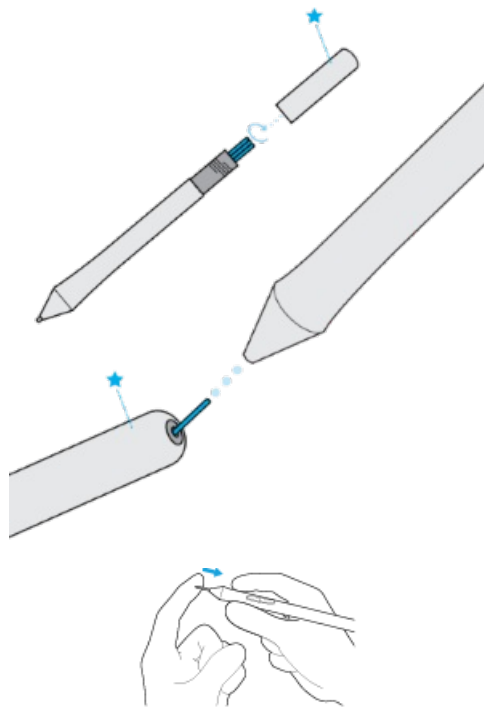

- Hold the pen in both hands, one near the end and the other near side buttons.
- Gently twist the pen to reveal the extra nibs inside.
- Use the back of the pen to remove your nib.
- Replace the nib by sliding the end straight into the barrel of the pen slowly and firmly until it stops.
- Gently twist the pen end back on the pen when finished.

Do NOT attempt to remove the pen end by pulling it. Do NOT over-tighten the pen end.

Use your pen with Windows Ink

You can take advantage of the variety of pen features that Microsoft Windows supports. All versions of Windows (except Windows 7 Starter and Home Basic) support them. Windows 10 and the Windows Ink Workspace provide additional features as well.

- **Handwriting recognition:** Convert your handwritten content to typed text.
- **Gestures:** Use touch gestures on the tablet to trigger customizable actions. To customize gestures, go to the **Flicks** tab in the Pen and Touch control panel.
- **Digital Ink** (Microsoft Office 2007 or later): Use the enhanced digital mark-up and inking tools found on the Review tab in applicable applications.
- **Windows Input Panel:** Use handwriting or an on-screen keyboard to directly enter text with your Wacom pen.

Note: The Pen Flicks and press-and-hold-to-right-click features are disabled in some graphics applications.

Windows Ink is ON by default. If you want to turn OFF Windows Ink, unselect **Use Windows Ink** in [Wacom Tablet Properties](#).

Advanced pen and eraser

To further customize tip or eraser pressure settings, select the Pen or Eraser tab and then click the **Customize** button. Options within the Pen Feel Details dialog let you independently change the tip or eraser pressure sensitivity and click threshold settings.

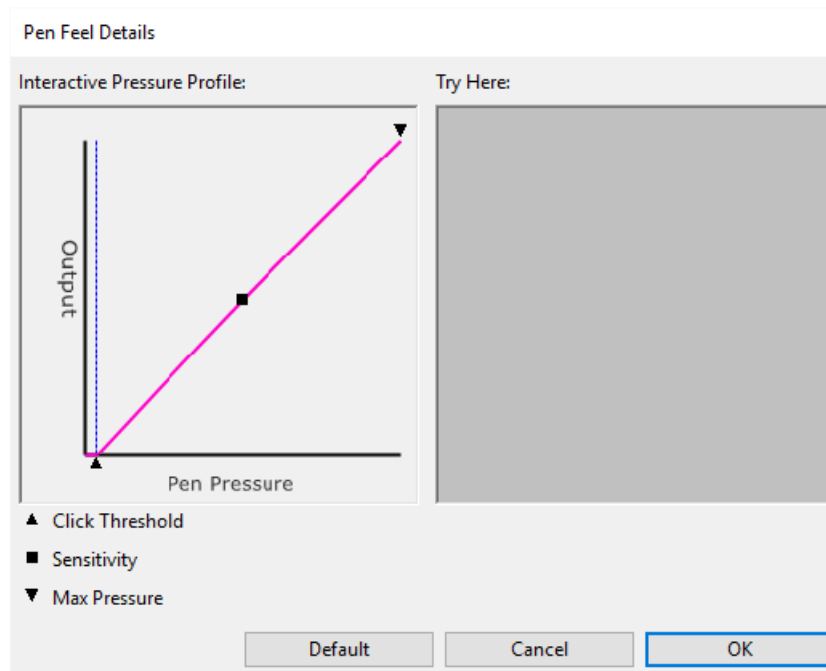

- The **Pen Feel Details** dialog shows the selected pressure sensitivity curve and click threshold settings. Move the pressure controls to change the settings.
- **Click Threshold** determines the amount of force required to register pressure or generate a pen click.
- **Sensitivity** changes the slope of the pressure response curve.
- **Max Pressure** determines how hard you must press the pen tip to reach maximum pressure.
- Using your pen tip or eraser, make several strokes within the **Try Here** box to test the results of your changes.
- A curve that increases quickly makes the pen feel more sensitive.

Note: In the Pen and Eraser tabs, pressure and sensitivity settings are adjusted with the **Tip Feel** or **Eraser Feel** slider, which will override the advanced pressure settings.

Customize your device in Wacom Tablet Properties

You can customize your device, pen, and other tools in Wacom Tablet Properties so that they work the way you want. [Open Wacom Tablet Properties](#) to view the settings [you can customize](#).

 **Important:** The options available in Wacom Tablet Properties will vary depending on your device.

What can I customize in Wacom Tablet Properties?

- Assign **Functions** to components like ExpressKeys™, Touch Rings, Rocker Rings, Touch Strips, pen buttons, and the pen tip.
- Select the settings that you want **Touch** gestures to activate.
- Assign settings that change depending on which application you are using by creating **Application Specific** settings.
- Create and assign **On-Screen Controls**, such as Screen Key panels and Radial menus.
- Define which devices to switch between when you **Display Toggle**, if you are using multiple devices or monitors.
- Return the settings on the tab that you are viewing to **Default** settings.
- Set advanced **Options**, such as how your pen tip performs clicks.

Where can I access settings and other options in Wacom Tablet Properties?

- **Device list**
 - There is an icon in this list for each device that is currently connected to your computer. To add a new device to this list, connect it to your computer.
 - Select a device from the **Device** list to view the **Functions** and **Touch** settings for it.
 - For some products, the Device List will not be present when only one tablet is attached.
- **Tool list**
 - There is an icon in this list for each tool that you recently used on this device. To add a new tool to this list, use the tool on your device.
 - Select a tool to view the settings for it.
 - Select **Functions** to view the settings for the device that you selected from the Device list, such as settings for ExpressKeys™ and Touch Rings.
 - For some products, the Tool List will not be present.
- **Application list**
 - Select **All** from the **Application** list to view the settings that apply across all applications.
 - If you created [Application Specific Settings](#), select an application icon from the **Application** list to view the settings that are specific to that application.
- **About button:** Select **About** to view software version information and access the **Diagnose** tool that can help you test your device.
- **? icon:** Select the ? icon to view User Help topics for the settings that you are currently viewing.

Open Wacom Tablet Properties

Once you open [Wacom Tablet Properties](#), you can view customizable settings for your device and tools.

 **Important:** The tabs and options that you see in Wacom Tablet Properties will vary depending on your device.

To open Wacom Tablet Properties:

- **Windows and Mac:** If your device supports it, you can open Wacom Tablet Properties from the **Wacom Desktop Center** by clicking on the name of your device under **My Devices** and selecting one of the settings.
- **Windows 10:** Click on the Windows Start button and select **Wacom Tablet > Wacom Tablet Properties**.
- **Windows 8.1:** Right-click in the bottom left-hand corner of the Start screen. Select **Wacom Tablet > Wacom Tablet Properties**.
- **Windows 8.1 Classic View:** Press the Windows key on your keyboard or select the Windows icon in the Charms bar to access the Start screen. Right-click in the bottom left-hand corner of the screen. Select **Wacom Tablet > Wacom Tablet Properties**.
- **Windows 7:** Click on the Windows Start button and select **All Programs**. Select **Wacom Tablet > Wacom Tablet Properties**.
- **Mac:** Open **System Preferences** from the Apple menu or from the Applications folder and click on the **Wacom Tablet** icon.

Assign settings in Wacom Tablet Properties

You can set a customizable component of your device to perform a function so that you can easily access settings that you use frequently. Some examples of customizable components that you can assign settings to are ExpressKeys™, pen buttons, the pen tip, Touch Rings, Rocker Rings, On-Screen Controls, touch gestures, and Touch Strips.

⚠ Important: The customizable components and the options available in Wacom Tablet Properties will vary depending on your device.

1. [Open Wacom Tablet Properties](#).
 - **Note:** Make sure that your device is connected to your computer or Wacom Tablet Properties will not open.

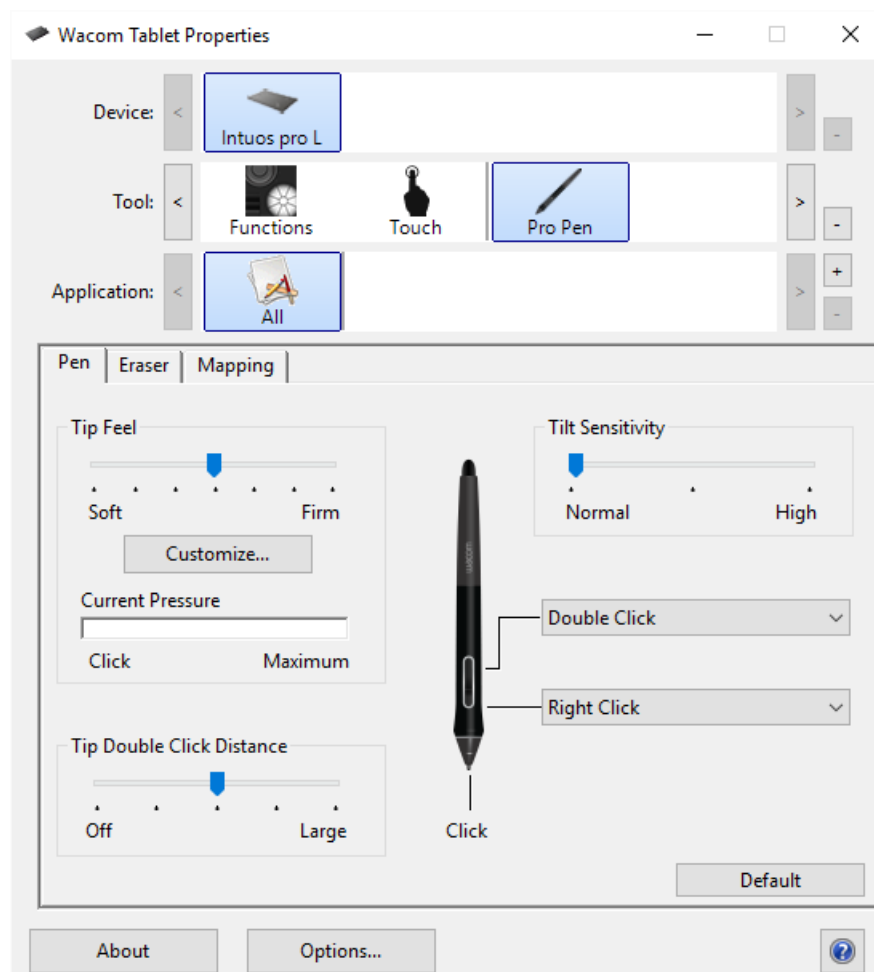

The above screenshot is for descriptive purposes, it may not match your screen.

2. Select your **Device**.
 - Any settings that you customize apply to this device only, except for On-Screen Controls.
 - For some products, the Device List will not be present when only one tablet is attached.
3. Select the **Tool** you want to customize.
 - If you want to assign settings to customizable components, like ExpressKeys™ or On-Screen Controls, select **Functions** from **Tools**.
 - If you want to assign settings to your pen or touch, choose the corresponding icon from **Tools**.
 - For some products, the Tool List will not be present.
4. Select the tab of the component you want to change.

5. From the drop-down menu next to the component that you want to customize, select the [setting](#) that you want to assign to it.
 - Any changes you make take effect immediately.
6. Engage the component that you customized, and the setting that you assigned is performed.

Tip: You can assign settings that [apply only in a specific application](#).

Example of assigning a setting in Wacom Tablet Properties

Here is how you can customize a pen button to **Zoom In**.

- Open Wacom Tablet Properties.
- Select your pen from the **Tool** list.
- Select the **Pen** tab.
 - An image of your pen is displayed on the tab.
 - Each pen button has a drop-down menu next to it that tells you the current setting assigned to it.
- From the drop-down next to one of the pen buttons, select **Zoom In**.
- Press that pen button, and your application zooms in.

What settings can I assign?

You can change the settings assigned to ExpressKeys™, Touch Rings, On-Screen Controls, pen buttons, and other customizable components of your device in [Wacom Tablet Properties](#). Then, when you engage that component, such as pressing an ExpressKey or pen button, the function that you assigned to it is performed.

Refer to this list of settings to help you decide if you want to change any settings that are already assigned.

⚠ WARNING: Make sure that the **Click** setting is assigned to at least one customizable component so you can always navigate and click.

4th click or 5th click	Performs a 4th or 5th mouse button click.
Application Defined	The application you are working in assigned a setting for this component.
Auto Scroll/Zoom	Assign this setting to the Touch Ring to zoom in most graphics applications or scroll in most other applications. Refer to the documentation for the application you are working in to see which setting has been assigned.
Back	Returns you to the previous step, similar to how Back works in browsers.
Click	Performs a mouse button click.
Click Lock	Presses and holds the mouse button. <ul style="list-style-type: none"> Begin the click lock by engaging a component, and then engage it again to release it. For example, if Click Lock is assigned to a pen button, press the pen button once to begin Click Lock and press it again to release the lock. Tip: Click Lock is helpful when you are dragging objects and selecting blocks of text.
Default	Resets the component to its default setting.
Disabled	Disables the component so that when you engage the component, such as pressing the pen button, nothing happens.
Display Toggle	Toggles between your devices and monitors, if you are using your device with multiple monitors or devices.
Double Click	Performs a double-click. Tip: For easier double-clicking, assign this setting to a component, such as a pen button, instead of tapping twice with the pen tip.
Erase	Sets your strokes with the pen to erase instead of draw. For example, if you assign Erase to your pen button, you can move your pen over an area you want to erase while pressing the pen button.
Forward	Directs you to a step ahead of where you are in your history, similar to how Forward works in browsers.
	Toggles Ink on and off.

<p>Ink Toggle (Mac)</p>	<ul style="list-style-type: none"> When Handwriting recognition is turned on, Ink recognizes and converts your handwriting into text and inserts it into a document.
<p>Keystroke</p>	<p>Performs the keystroke or combination of keystrokes that you assign.</p> <p>When you select Keystroke, the Define Keystroke window appears so you can select a keystroke or create a keystroke combination.</p>
<p>Launchpad</p>	<p>Displays the Launchpad menu, where you can start applications.</p>
<p>Middle Click</p>	<p>Performs a middle mouse button click.</p>
<p>Mode Toggle</p>	<p>Assign this setting to a pen button to toggle between Pen mode and Mouse mode.</p> <ul style="list-style-type: none"> When you first set a pen button to Mode Toggle, the Mouse Mode window appears. Move the sliders to adjust the mouse acceleration and speed. In Pen mode, you use the pen like a regular pen. The cursor jumps to the point where you place your pen, and you define which portion of your device maps to which portion of your monitors. In Mouse mode, you use the pen like a mouse. The cursor stays on the point you left it when you pick up your pen, and you interact with your device like you interact with a mousepad.
<p>Modifier</p>	<p>Performs a modifier (Shift, Alt, Ctrl, Option, Command) plus a mouse button click or mouse wheel scroll.</p> <ul style="list-style-type: none"> When you select Modifier, the Define Modifier window appears. Select the modifier and then select a mouse button click or mouse wheel scroll to assign that combination.
<p>On-Screen Controls</p>	<p>Displays the On-Screen Control that you select.</p> <ul style="list-style-type: none"> When you select On-Screen Controls, the list of Screen Key panels, Radial Menus, and Keypads from the On-Screen Controls tab appears. Select the On-Screen Control that you want to assign.
<p>On-Screen Keyboard</p>	<p>Toggles the Windows On-Screen Keyboard open and closed.</p>
<p>Open/Run</p>	<p>Opens or runs the application, file, or a script you choose.</p> <ul style="list-style-type: none"> When you select Open/Run, the Run Application window appears. Click Browse and select the item. Click OK.
<p>Pan/Scroll</p>	<p>Allows you to pan or scroll in a document or item by moving the pen tip up and down or right and left.</p> <p>When you select Pan/Scroll, the Scroll Speed window appears. Move the slider to your preferred scrolling speed.</p>
	<p>Pans or zooms, depending on whether you are hovering or touching the device surface.</p> <ul style="list-style-type: none"> To pan, hover above (but do not touch) the device surface, and then press and hold the button while

<p>Pan/Zoom</p>	<p>moving your pen.</p> <ul style="list-style-type: none"> To zoom, press and hold the button while touching the device surface and move the pen towards the top to zoom out or towards the bottom to zoom in. <ul style="list-style-type: none"> If you pick up your pen to hover, zooming stops. As long as you continue to hover and hold the button, you can still zoom when you touch the pen tip to the surface again. If you want to pan again after zooming, release the button and press it again. <p>Notes</p> <ul style="list-style-type: none"> If the application does not support Pan/Zoom, the following happens instead: <ul style="list-style-type: none"> Pressing the button while hovering activates a Ctrl + Right-Click. Pressing the button while touching the surface activates a mouse wheel scroll. When you select Pan/Zoom to assign it to a button, the Zoom Speed window appears. Move the slider to your preferred zooming speed. Changing the side switch mode does not affect this setting.
<p>Precision Mode</p>	<p>Toggles between normal precision and a precision that you choose, from Fine to Ultra Fine.</p> <ul style="list-style-type: none"> In the Precision Mode window that appears, move the slider to set the precision that you toggle into. For example, if you assign Precision Mode to a pen button, when you press the pen button, you switch to working in the precision that you selected from the slider. When you press the pen button again, you switch back to working in the normal precision.
<p>Pressure Hold</p>	<p>Locks the pressure at the current level until you release the component.</p> <p>For example, if you assign this setting to a pen button, you can paint with pressure sensitivity enabled in your application until you reach the brush size you like. Then, press and hold the pen button to lock in that brush size as long as you are pressing and holding the button.</p>
<p>Right Click</p>	<p>Performs a right mouse button click.</p>
<p>Scroll</p>	<p>Scrolls when you use the Touch Ring.</p>
<p>Scroll Down</p>	<p>Scrolls your active application down.</p>
<p>Scroll Up</p>	<p>Scrolls your active application up.</p>
<p>Settings</p>	<p>Displays the current settings of your customizable components, including ExpressKeys™, the Touch Ring, pen, and touch.</p> <p>Click on any item that displays to open Wacom Tablet Properties so you can adjust setting assignments, if desired.</p>
<p>Show Desktop</p>	<p>Minimizes all open windows so you can view your desktop.</p>
<p>Skip</p>	<p>Assign this setting to the Touch Ring center button so you can skip one of the settings that you assigned to the Touch Ring.</p>
<p>Switch Application</p>	<p>Toggles between the applications that you have open.</p>

Tablet PC Settings	Displays the Tablet PC Settings menu.
Touch On/Off	Toggles touch on and off. This setting is not available on devices that have a built-in touch on/off switch or button.
Tumble	Tumbles, orbits, or rotates items in 3D applications. If the application does not support Tumble, pressing the button activates a middle-click instead.
Zoom	Zooms the active application on your computer. Assigned to a Touch Ring: Slide your finger around the ring clockwise to zoom in and counterclockwise to zoom out. Assigned to a pen button or ExpressKey: Press and hold the button while touching the pen tip to the device surface and move towards the top to zoom out or towards the bottom to zoom in. If you pick up your pen to hover, zooming stops. As long as you continue to hover and hold the button, you can still zoom when you touch the pen tip to the surface again. Notes <ul style="list-style-type: none"> • If the application does not support Zoom, pressing the button activates a mouse wheel scroll instead. • When you select Zoom to assign it, the Zoom Speed window appears. Move the slider to your preferred zooming speed. • Changing the side switch mode does not affect this setting.
Zoom In	Zooms your active application in.
Zoom Out	Zooms your active application out.

Note: Some of the settings listed are not available for all devices or for all customizable components. Refer to the drop-down menus on the **settings** tabs in [Wacom Tablet Properties](#) to see which options are available for which components.

Assign keystrokes

You can assign keystrokes to customizable components of your device, like ExpressKeys™ and pen buttons, so you can press a button on your device instead of pressing the keystroke on your keyboard. You can also assign a combination of keystrokes, so you only have to press one button instead of the entire keystroke combination.

1. Go to [Wacom Tablet Properties](#).
2. Select **Keystroke** from the drop-down menu of one of your device's customizable components.

The **Define Keystroke** window appears.

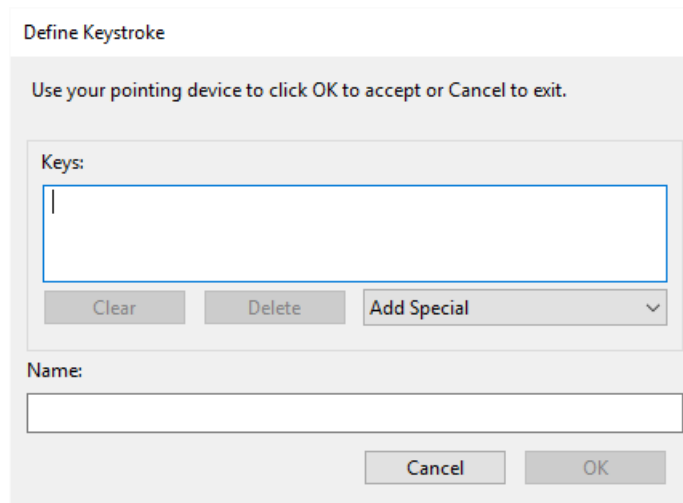

3. In the **Keys** box, enter the keystroke that you want to assign. If you want to assign a combination of keystrokes, enter each keystroke that you want in the combination.
 - You can enter letters, numbers, function keys, and modifier keys. You can also choose combinations from the **Add Special** drop-down.
 - Click **Delete** to remove only the last keystroke you entered.
 - Click **Clear** to remove all the keystrokes you entered so you can start over.
 - **Note about Touch Rings and mouse wheels:** Two **Keys** boxes appear for Touch Rings and mouse wheels. Enter the keystroke for clockwise or forward wheel movement in the first box and counterclockwise or backward wheel movement in the second box.
4. Enter a **Name** for your keystroke and click **OK**.
 - The name appears on On-Screen Controls, in Wacom Tablet Properties, and in Settings view, so enter a name that indicates the keystroke you assigned.
 - If you are assigning numbers to a Keypad, it is best practice to name the Keystroke the number that you assigned. For example, if you assign the number 8 to a Keypad button, name the Keystroke **8**.

Tip: You can assign different keystroke combinations to [the same customizable component for different applications](#).

To learn which keystroke combinations are built-in as shortcuts for a particular application, refer to the documentation for the application.

ExpressKeys™

ExpressKeys™ are customizable buttons on your device. When you press an ExpressKey, you activate the assigned setting, such as mouse clicks, modifiers, or navigation functions.

You can view and change which settings are assigned in [Wacom Tablet Properties](#).

1. In Wacom Tablet Properties, if there are **Device** and **Tool** rows, select your device and then select **Functions**.
2. Click the **ExpressKeys™** or **Tablet** tab, depending on your device.
3. Select the setting that you want for each ExpressKey from the drop-down.

Tips

- You can use ExpressKeys™ in combination with one another. For example, assign Ctrl to one ExpressKey and Alt to another. When you press both ExpressKeys™ at the same time, you activate a Ctrl+Alt function.
- If your device has ExpressKeys™ on both sides, you can assign settings to the **Left** and **Right** sides individually.
- You can enable **Express View** so that you can rest your finger on an ExpressKey to show the current settings.
- Some [applications override the ExpressKey settings](#).

 **Important:** ExpressKeys™ will vary, depending on your device.

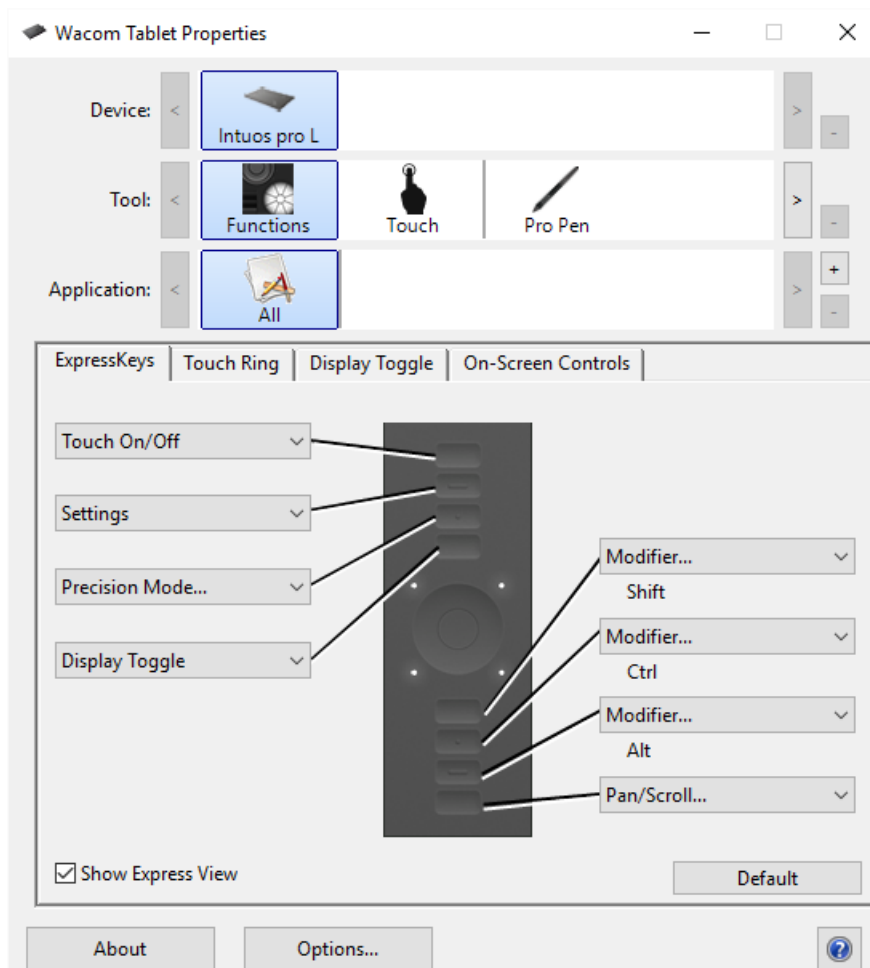

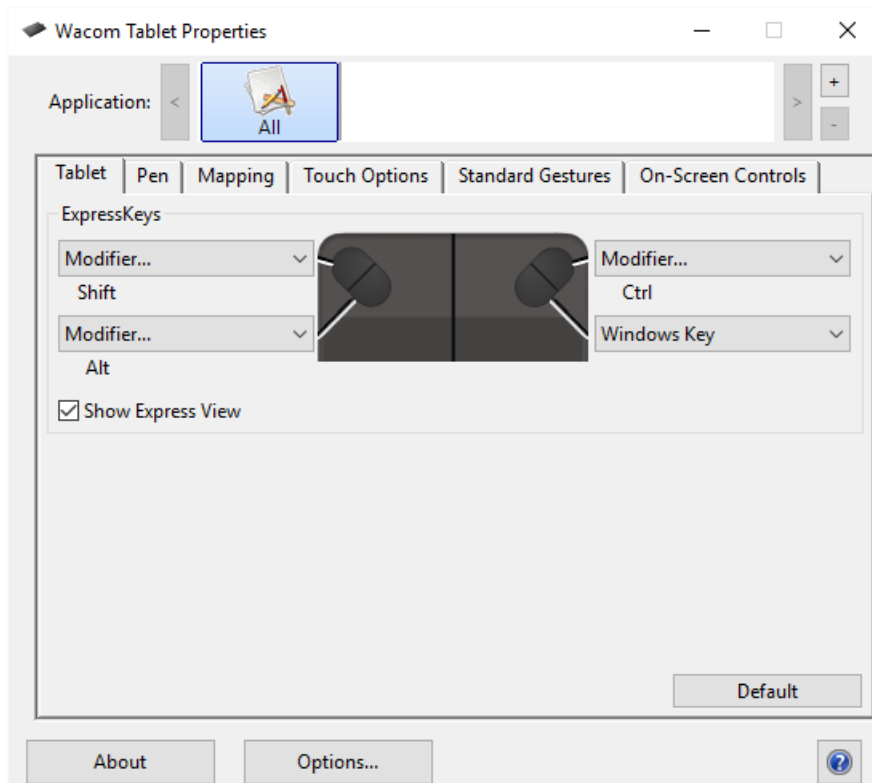

The size and placement of ExpressKeys™ vary, depending on your device. Your screen may match one of the above screenshots or may be different. The screenshots are for descriptive purposes.

Express View

You can enable Express View to see the current settings for your ExpressKeys™ at any time.

- Check the **Show Express View** checkbox on the ExpressKeys™ tab.
- Press any ExpressKey to view the current ExpressKeys™ settings on your screen.

The display will fade out after 2 seconds on the screen. Express View may vary in appearance, depending on the Intuos model you are using.

To disable the display, uncheck the **Show Express View** box.



The above screenshot is for descriptive purposes, it may not match your screen.

Important: Some applications can override and control the ExpressKey functions.

Customize user options

Click on **Options** in [Wacom Tablet Properties](#) to customize side switch mode and other preferences for your device.

⚠ Important: The available options will vary depending on your device.

- **Hover Click** is the default and allows you to click by pressing the pen button while holding the pen tip slightly above the device surface.
- Select **Click & Tap** if you want to click by pressing the pen button and tapping the pen tip to the device surface.
 - Choose this option for more precise placement of clicks.
- Move the **Brightness Adjustment** slider to adjust the brightness level or to turn off status LEDs and active area markers.
- If you are using graphics applications that support a maximum of 1024 levels of pressure, select **Pressure Compatibility**.
- For devices that support wireless, select **Show wireless tablet battery** if you want to display the battery status icon in your system tray during wireless operation.
- For devices that have ExpressKeys™ on both the right and left sides and that are connected to a macOS computer, change the **Handedness** to swap the ExpressKey settings.

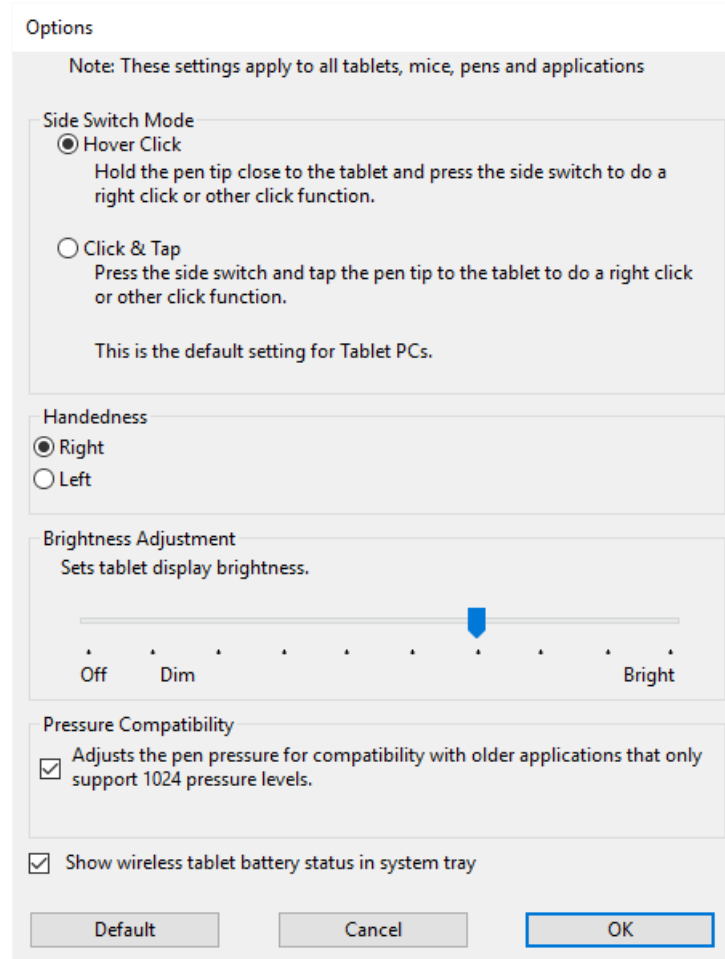

The above screenshot is for descriptive purposes, it may not match your screen.

Use On-Screen Controls as shortcuts

On-Screen Controls are menus that display on your pen display screen or monitor. You can use On-Screen Controls as shortcuts to the settings that you use the most.

How to create and use an On-Screen Control

1. Create a new [On-Screen Control](#).
2. Assign settings to the [Radial Menus](#), [Screen Keys](#) and [Keypads](#) that you created.
3. [Assign the On-Screen Control to a customizable component](#) of your device, such as an ExpressKey™ or pen button.
4. Press the button, ExpressKey™, or other component to open the On-Screen Control.
 - For example, if you assigned an On-Screen Control to an ExpressKey™, press the ExpressKey™ to display the On-Screen Control.
5. Click a button or slice in the On-Screen Control to activate the setting you assigned.
 - For example, if you assigned **Zoom In** to a Screen Key, click that Screen Key to zoom in.

Tip: Instead of opening the On-Screen Control every time you need it, you can select the push pin icon to keep it open at all times.

On-Screen Control layouts

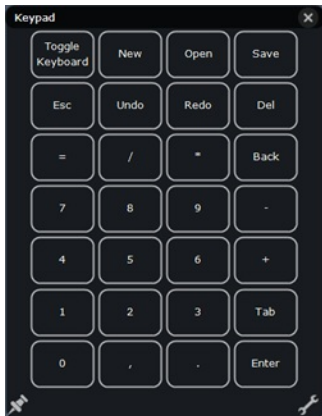

Keypad: A Keypad is a similar to your keyboard keypad, displayed on your monitor.



Screen Key panel: A Screen Key panel is a row of buttons that displays in the layout you choose.



Radial menu: A Radial menu is a circle split into slices, and each slice has its own setting.

Tip: You can select the wrench icon to open [Wacom Tablet Properties](#).

Create On-Screen Controls

You must first create a new On-Screen Control, or copy an existing one, and then you can [assign settings to it](#).

Important: On-Screen Controls are not specific to a device. You can assign them to a customizable component of any device that appears in Wacom Tablet Properties.

1. Open [Wacom Tablet Properties](#).
2. Select **Functions** from the **Tool** list.
3. Select the **On-Screen Controls** tab.

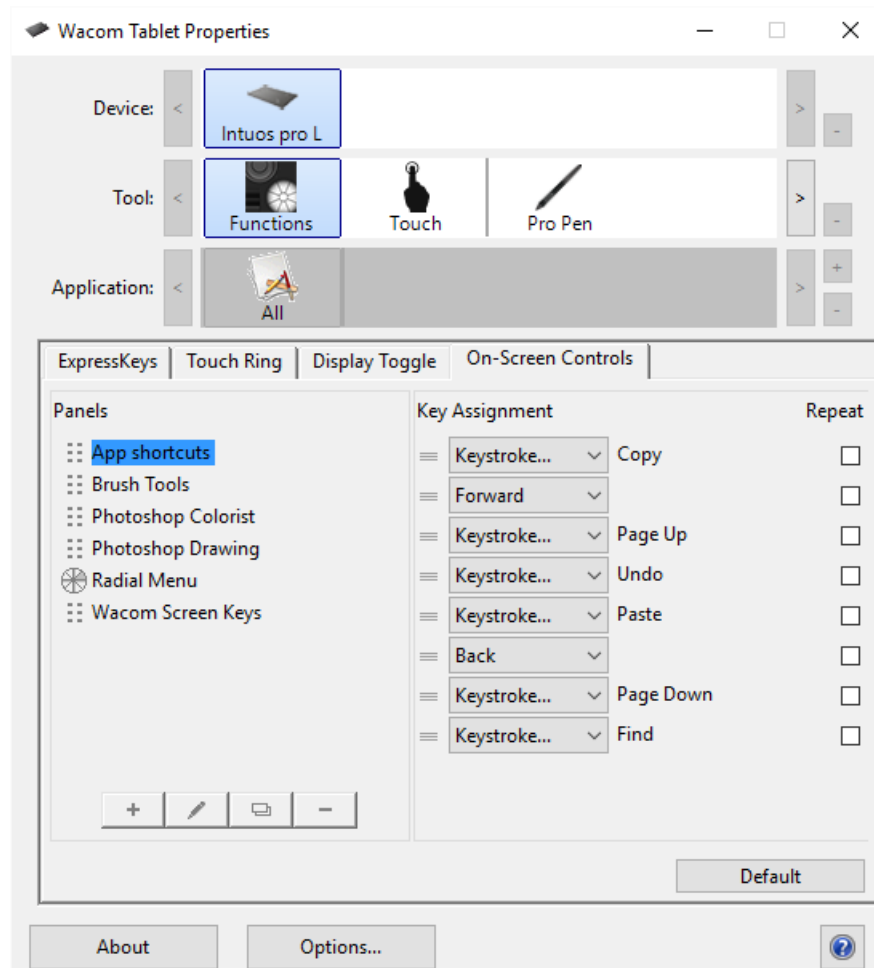

The above screenshot is for descriptive purposes, it may not match your screen.

4. Select if you want to create a new On-Screen Control or select if you want to copy an existing one.

Note: You can also select an existing On-Screen Control and click to edit it or to delete it.

5. In the window that appears, enter a **Name** and select a **Layout** by clicking one of the layout buttons.

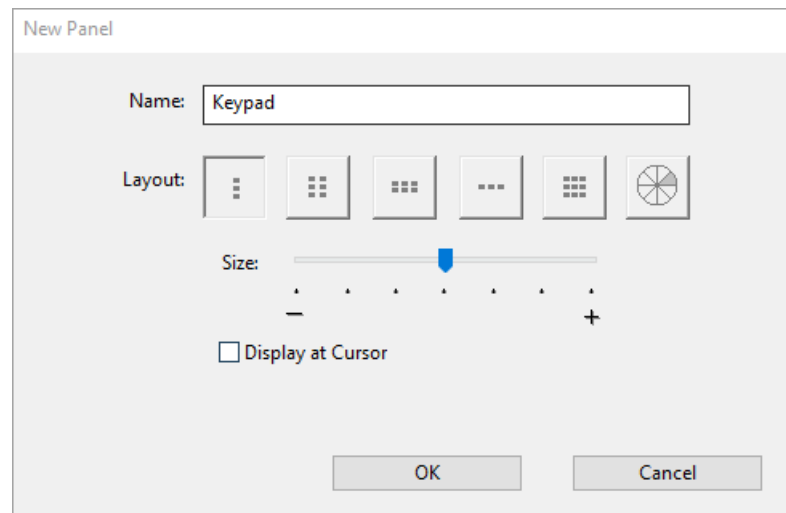

- You can move the **Size** slider to change the size of the On-Screen Control when it appears on your screen.
- You can select **Display at Cursor** if you want the On-Screen Control to appear next to your cursor when you open it. If you do not select this, the On-Screen Control appears in the same location every time you open it.

6. Click **OK**.

- The On-Screen Control that you just created appears in the **Panels** list on the **On-Screen Controls** tab.

7. Assign settings to your [Radial Menus](#), [Screen Keys](#) and [Keypads](#).

Tip: You can create an On-Screen Control and then switch the layout whenever you want.

- From the **Panels** list, select the On-Screen Control that you want to change.
- Click  to edit.
- Select a new layout, and click **OK**.

If you switch to an On-Screen Control that has fewer settings than your original one, your settings are not lost. For example, if you create a Keypad and then change it to a Radial Menu, your first eight settings display in the Radial menu. If you switch back, all of your original Keypad settings are still there.

Assign settings to Radial Menu and Screen Keys

After you [create a Radial Menu or Screen Key panel](#), you need to assign settings to the buttons and slices. You can change the settings at any time if you decide that you want different settings.

- In Wacom Tablet Properties on the **On-Screen Controls** tab, select the name of the On-Screen Control in the **Panels** list.
 - A drop-down menu for each button in your On-Screen Control displays under **Key Assignment**.
- Select the [setting](#) that you want to assign to each button from the drop-down menus.
 - You must assign a setting to at least one button. For any buttons that you do not want to use, select **Disabled**.
 - If you select **Keystroke**, you are prompted to [select a keystroke or create a keystroke combination](#).

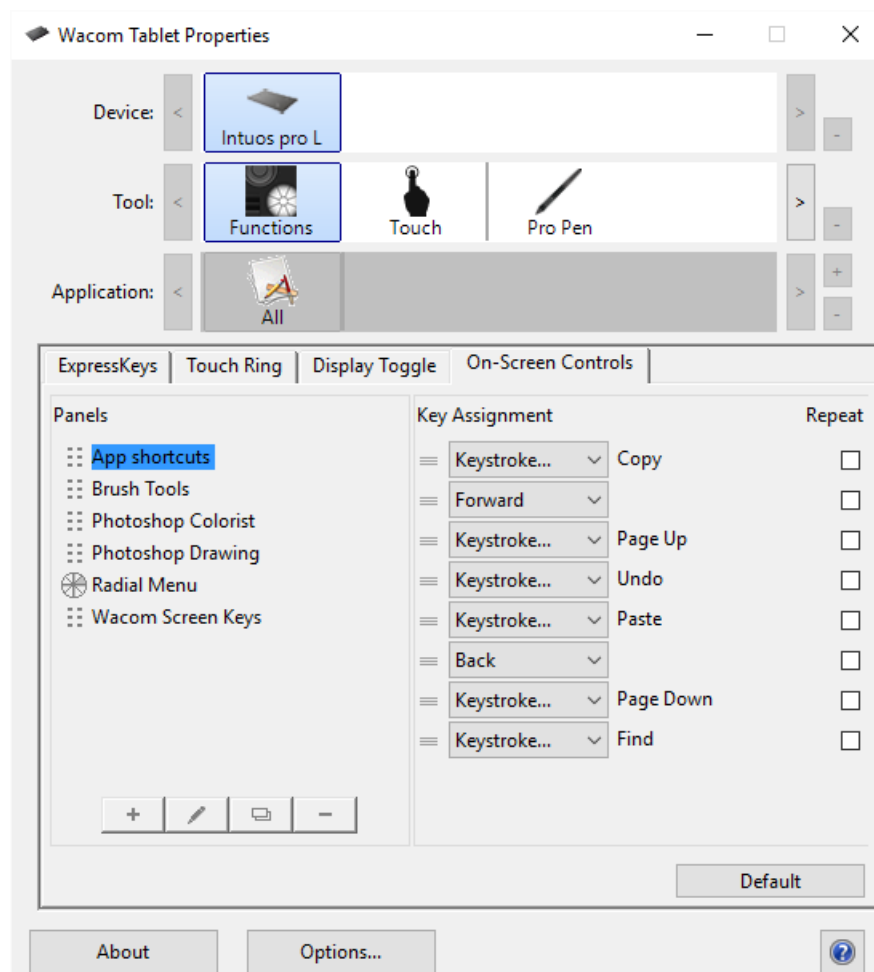

The above screenshot is for descriptive purposes, it may not match your screen.

- Change any of the optional features:
 - To change the order of the settings, click  and drag it to a new position.
 - If you want the setting to repeat when you click and hold the On-Screen Control button, select **Repeat**.

⚠ Important: [Assign your On-Screen Control to a customizable component](#), like an ExpressKey or pen button, so that you can open it when you want to use it.

Assign settings to Keypads

After you [create a Keypad](#), you can change the settings assigned to the buttons so that the Keypad includes the settings you want.

- In Wacom Tablet Properties on the **On-Screen Controls** tab, select the name of the Keypad in the **Panels** list.
 - An image of a Keypad appears under **Key Assignment** with default settings assigned to it.

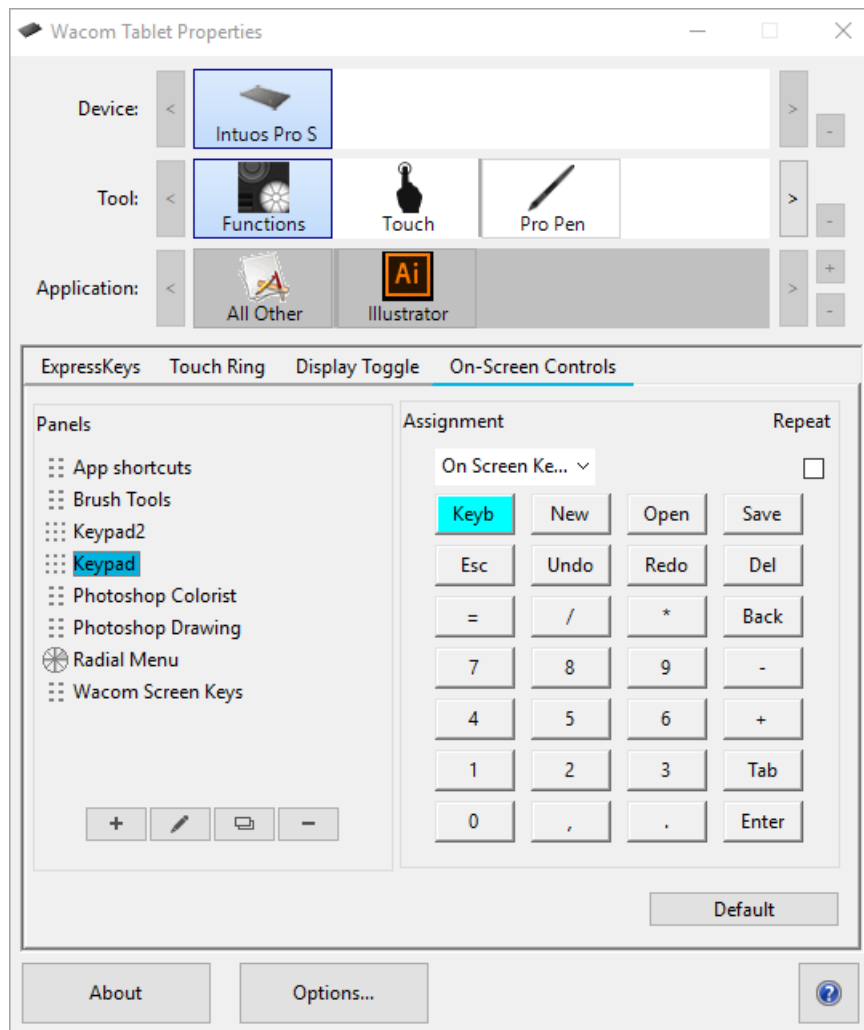

- Click a Keypad button that you want to change.
- Select the [setting](#) that you want to assign from the **Assignment** drop-down above the Keypad.
 - To assign numbers, select **Keyboard > Keystroke**. When you select **Keystroke**, you are prompted to [select a keystroke or create a keystroke combination](#).
 - If you want the setting to repeat when you press and hold the Keypad button, select **Repeat**.
 - You must assign a setting to at least one button. For any buttons that you do not want to use, select **Disabled**.

[Assign your On-Screen Control to a customizable component](#), like an ExpressKey or pen button, so that you can open it when you want to use it.

Assign On-Screen Controls

After you [create an On-Screen Control](#) and [assign settings to it](#), you need to assign the On-Screen Control to one of your device's components so that you can open it. You can assign On-Screen Controls to ExpressKeys™, touch gestures, and pen buttons, depending on the features available on your device.

In this example, you can see how to assign an On-Screen Control to an ExpressKey™.

- Open Wacom Tablet Properties and select your **Device**.
- Select **Functions**.
- Select the **ExpressKeys™** tab.
- From the drop-down next to one of the ExpressKeys™, select **On-Screen Controls**.
- From the list that appears, select the name of an On-Screen Control.
 - The assignment takes effect immediately.
- Press the ExpressKey™, and the On-Screen Control that you selected displays on your device or monitor. Click one of the buttons in the On-Screen Control to activate the setting that you assigned to it.

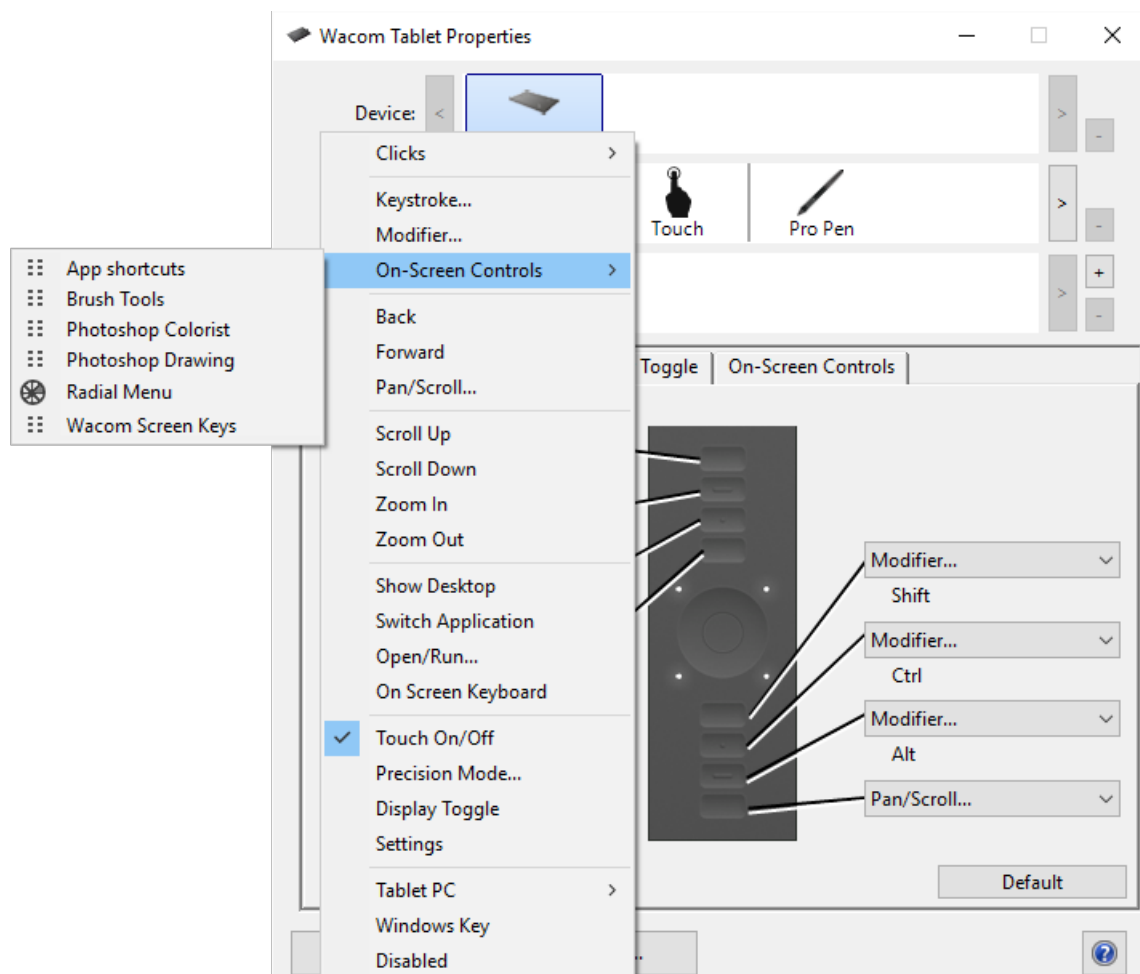

The above screenshot is for descriptive purposes; it may not match your screen.

Access application-specific settings

Settings assigned to customizable components can be further customized for a specific application. This makes performing functions in the application faster and easier. There are multiple ways to access those application-specific settings.

- **Settings assigned by you:** You can assign your own settings that change depending on the application you are working in.
- **Settings assigned by applications:** Some applications assign settings to customizable components so that when you open that application, you are automatically using the settings assigned by it.
- **Imported settings assigned by applications:** Some applications include an XML file that assigns settings to customizable components. After you import the file and open that application, you are automatically using the settings assigned by the settings file.

Some examples of customizable components that might have customized settings assigned are ExpressKeys™, pen buttons, the pen tip, Touch Rings, Rocker Rings, On-Screen Controls, touch gestures, and Touch Strips.

 **Important:** The customizable components may vary depending on your device.

Application-specific settings assigned by you

The **Application** list enables you to add individual applications, and then customize your tool settings for that application. For example, if you select an application icon and change the Pen settings, the changes will apply to the Pen only while you are using that application. Application-specific settings can be used with all Wacom pen tablets and pen displays, and with the ExpressKey Remote device.

- When application-specific settings are added, the **All** icon changes to **All Other**, and an application icon is displayed for the newly added application(s).
- After adding an application, its icon appears in the Application list whenever the associated tool is selected in the **Tool** list.
- Select the application, then customize the [Wacom Tablet Properties](#) tab settings for your tool and application.

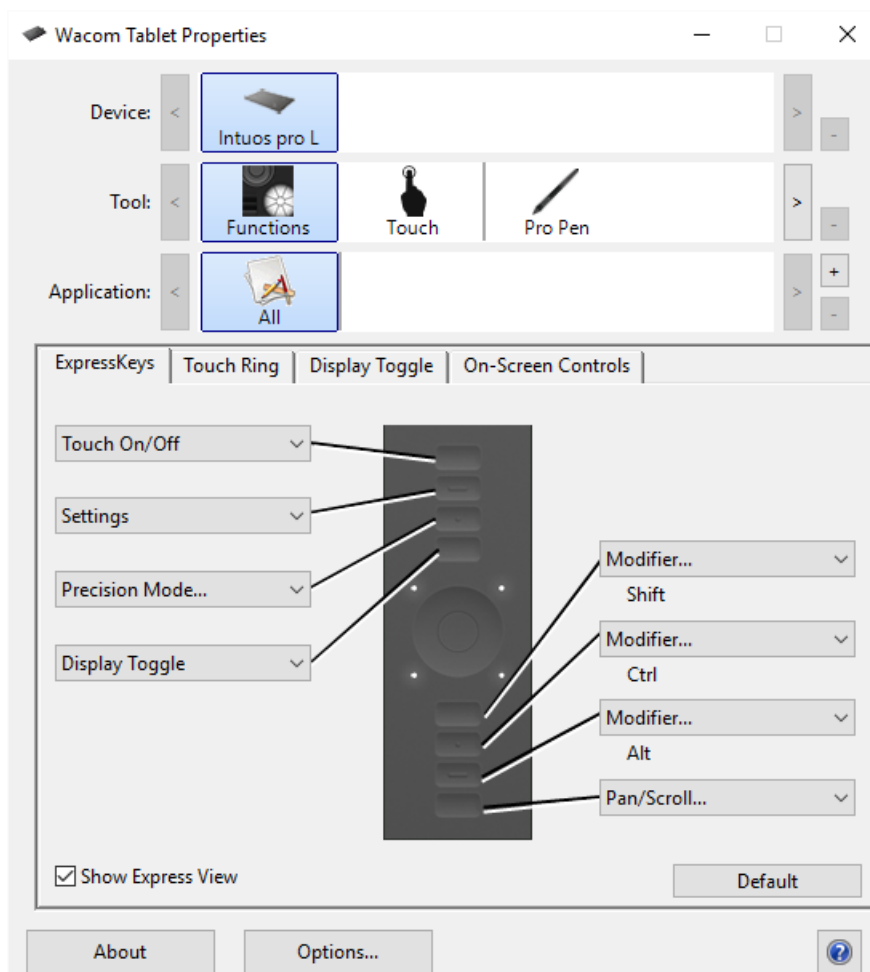

The above screenshot is for descriptive purposes, it may not match your screen.

To create an application-specific setting:

1. In the Tablet Properties, choose the **Device** and **Tool** for which you want to create an application-specific setting.
2. In the **Application** list click the **+** button.
3. In the **Currently Open Applications** box, select an application for which to create custom settings, or browse to select the executable file of any application installed on your computer.
4. Click **OK**.

To remove an application-specific setting:

1. In the **Tool** list, select the tool from which you want to remove the application-specific setting.
2. In the **Application** list, select the application you want to remove.
3. Click on the **Application** list - button. In the dialog, click **Delete** to confirm your selection. The selected application is removed from the list, along with any custom tool settings.
4. To remove all application-specific settings from a tool, remove it from the **Tool** list. Then place the tool back on the tablet. The tool will be added back to the **Tool** list using the default settings.

Note: This method cannot be used to remove custom **Functions** settings.

If you are working with a commonly used application such as Photoshop or Illustrator, your tablet's software will identify the application and set the ExpressKeys™ to commonly used functions for that application.

Notes:

- If two programs have the same executable file name, they will share the same customized settings.
- If you are using an application for which you have already customized your ExpressKeys™, those settings will take precedence over any automatic ExpressKey default settings provided by that application. Default settings will take effect automatically only if you have not entered your own ExpressKey settings for that application.

Settings assigned by applications

Some applications assign settings to [customizable components](#). When you open that application, you are automatically using the settings assigned by it.

How do I know what setting is assigned?

- After you open an application that assigns settings, you can view the assigned settings in Wacom Tablet Properties.
 - If you see **Application Defined** in the drop-down next to a component, it means that the application you are working in has assigned that setting. But, **Application Defined** does not display for every assigned setting. Sometimes, the name of the function displays instead. Refer to the documentation for that application to learn which settings are assigned.
- When you close the application or when you start working in another application, the settings revert back to their previous assignments.

Tip: You do not have to use the settings assigned by applications. You can [change the settings](#) in Wacom Tablet Properties.

Settings assignments work differently for different customizable components

 **Important:** The customizable components available will vary depending on your device.

- An application may assign settings to some, but not all, **ExpressKeys™**. To find out if an application assigned settings to any ExpressKeys™, refer to the documentation for that application.
- If an application assigns a setting to any part of a **Touch Ring** or **Touch Strip**, all settings for the Touch Ring or Touch Strip are changed. If the application did not assign settings to cover the entire Touch Ring or Touch Strip, the unassigned settings are changed to **Skip**.

Imported settings assigned by applications

Some applications include an XML settings file that assigns settings to [customizable components](#). After you import the file and open that application, you are automatically using the settings assigned by the settings file.

Note: If the settings file does not assign a setting for a customizable component, then the setting stays the same as it was before the import.

1. Back up your settings by going to **Backup Settings** in the [Wacom Desktop Center](#).
2. After you back up your settings, double-click the customized settings file.
3. Follow the prompts in the window that appears.

Open [Wacom Tablet Properties](#) to view the imported settings.

Tip: You do not have to use the settings assigned by the settings file. You can [change the settings](#) in Wacom Tablet Properties.

Wacom Desktop Center

The Wacom Desktop Center helps you keep your driver and products up-to-date, customize your devices, and learn more about how to use pen tablets and pen displays.

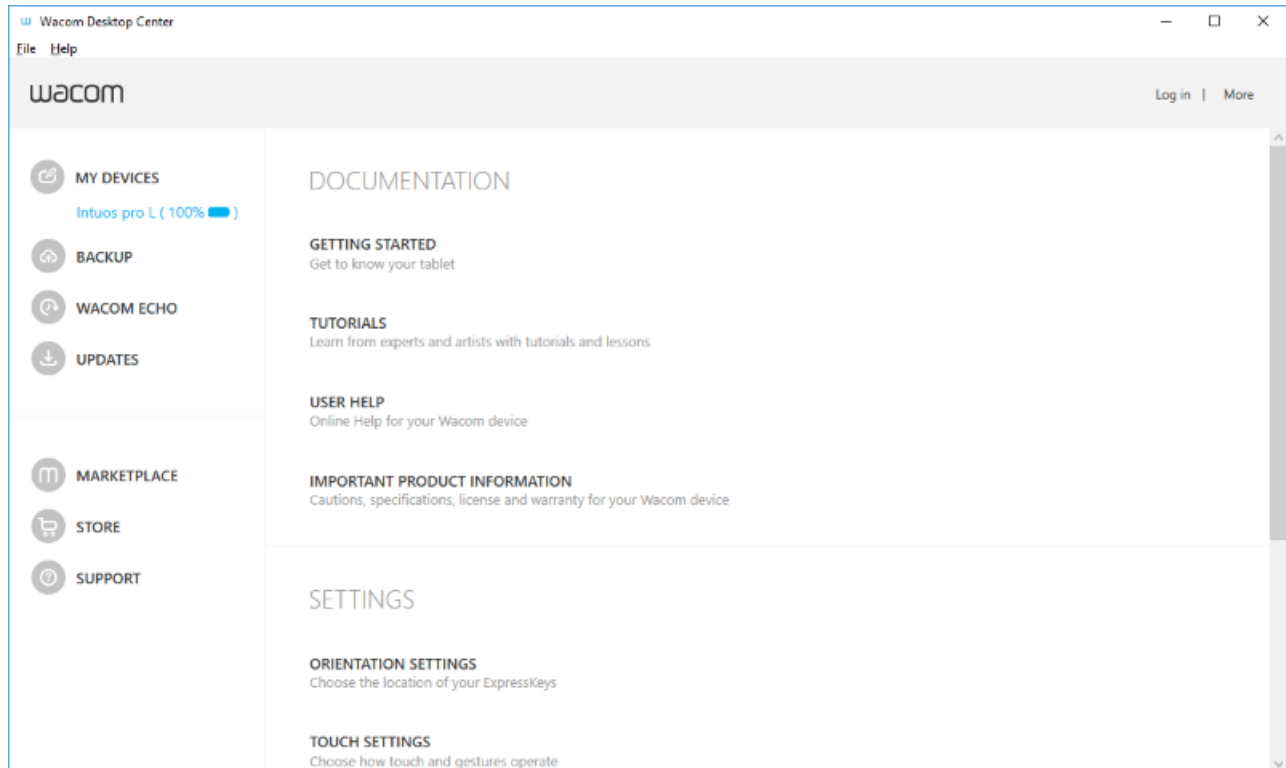

The above screenshot is for descriptive purposes, it may not match your screen.

Customizing your device

- If available for your device, the pen displays and pen tablets that are connected to your computer display under **My Devices**.
- Select a device to display settings menus.
- Select one of the settings menus, and Wacom Tablet Properties opens so you can change the settings.

Running the Setup Wizard

- If available for your device, select your device from **My Devices**, and select **Run Setup Wizard**. Follow the prompts.

Redeeming Software

- If available for your device, select your device from **My Devices**, and select **Redeem Software**. Register your product to get the software that came with it.

Backing up your settings

- Click **Backup Settings** to backup, restore, and reset your device settings.
- These settings can be stored locally or to your Wacom ID.
- **Note:** Settings can only be restored to the device that they were created on.

Backing up your files

- **Important:** Currently available on MobileStudio Pro only.
- You can set up **Wacom Echo** to automatically back up your drawings, notes, and any other files stored on your tablet or computer, if you are using Windows 10.

Updating your tablet

- If available for your device, you are notified of driver, firmware, or BIOS updates by a notification next to **Updates**.
- Select **Updates**, and then click the update to install it.

Getting apps and products

- Click **Marketplace** to find apps that can improve your workflow.
- Click **Store** to research and purchase Wacom products.

Getting Support for Wacom products

- Select **Support** to view FAQs and tutorials on the Wacom website and to contact Support.
- If available for your device, select a device under **My Devices** to view documentation, tutorials, and Important Product Information.
- Go to **More > Online Help** or **Help > Online Help** to view help topics.

Logging in with your Wacom ID

- **Log in** with your Wacom ID so you can access the Wacom Cloud.
- Click your name to view and update your profile.

Click **More** to change privacy settings, to configure how the Wacom Desktop Center starts up, to access help, and to find Wacom on social media.

Map your device to your monitor

You can customize how the surface of your device maps to your monitors and how your pen movements relate to the cursor movements on your monitor by selecting either [Pen](#) or [Mouse](#) mode.

Tip: If you frequently switch between Pen mode and Mouse mode, assign the [Mode Toggle](#) to a customizable component, like an ExpressKey or pen button, so that you can switch at the press of a button.

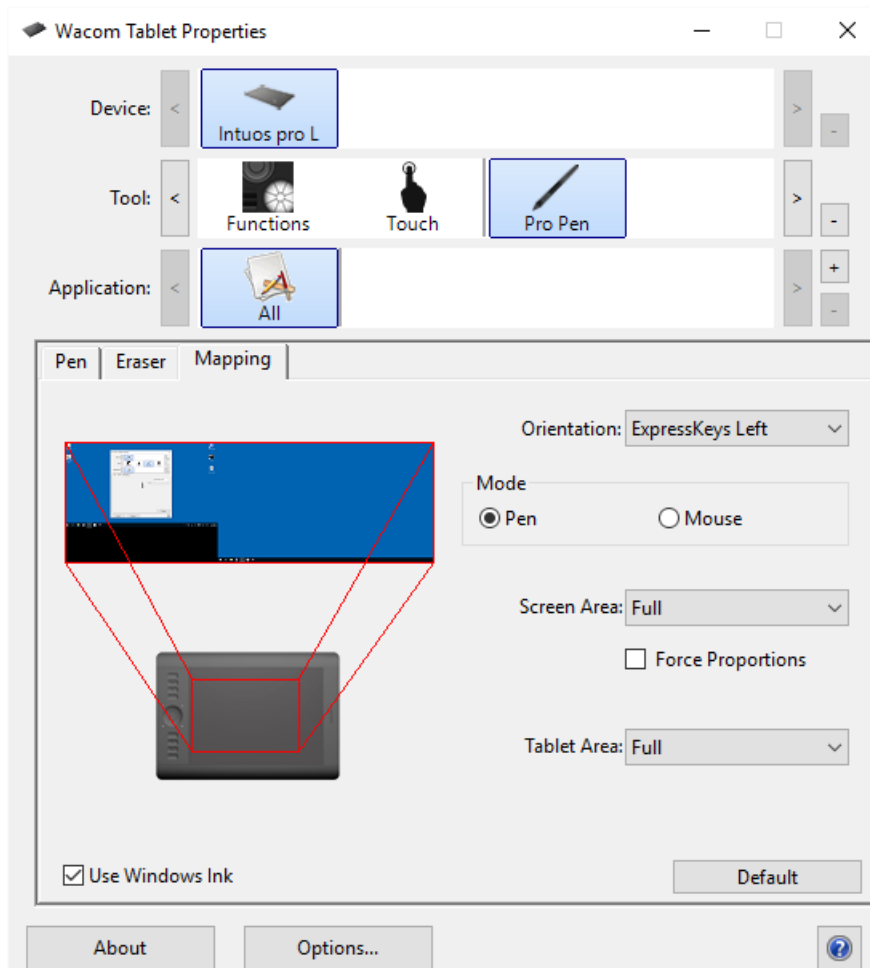

The above screenshot is for descriptive purposes, it may not match your screen.

If supported by your device, you can change the **Orientation** that your tablet is used in by selecting the side of the device that you want the ExpressKeys™ on. This setting applies to all tools and applications.

To take advantage of the pen features that Microsoft Windows supports, select [Use Windows Ink](#).



Map your device in pen mode

In **Pen** mode, you use the pen like a regular pen, and you interact with the device as if it is your paper. Each point on the device maps absolutely to a specific point on your monitor, and the cursor jumps to the corresponding point on your monitor when you place your pen on the device.

If you select **Pen** mode, you can see a representation of how your device maps to your monitors on the **Mapping** tab. If you want a different mapping than what is shown, you can change it.

1. In Wacom Tablet Properties, select your pen from the **Tool** list and then select the **Mapping** tab.
2. From **Mode**, select **Pen**.
 - By default, the active area of the device maps to your entire monitor. If you are using more than one monitor, the device maps to all monitors.

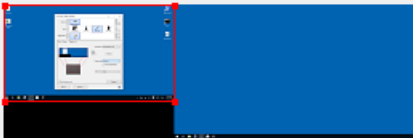
 **CAUTION:** If you change the display properties in your computer's display menu, you are also changing the mapping on this tab.
3. From **Screen Area**, select which part of your monitor that you want the device to map to:
 - Select **Full** if you want to map to the entire area of the monitors connected to your computer.
 - Select **Portion** if you want to define a section of your monitor to map to. Select the section in any of the following ways:
 - Under **Drag Handles**, drag the corners of the red border to define the screen area that you want to map to.
 - Select **Click to Define** and use your cursor to select the screen area that you want to map to.
 - **Enter Coordinates** in pixels.
 - Select a **Monitor** if you want to map to the entire area of a single monitor.
4. From **Tablet Area**, select which part of your device that you want mapped to the **Screen Area** you selected.
 - The options are similar to the **Screen Area** options.
5. Select **Force Proportions** if you want the vertical and horizontal proportions to be the same on your device as on your monitors.
 - If you select **Force Proportions** and draw a circle on the device, it displays as a circle on the screen, but a portion of the device active area may no longer be usable.
 - If you do not select **Force Proportions** and draw a circle on the device, it might display as an ellipse on the screen.
 - **Tip:** To help you decide which setting to select, watch the red borders of the image on this tab while selecting and unselecting **Force Proportions** to see how it affects mapping.

Portion of Screen	Portion of Tablet																
<p>Choose one of the following three ways to define Portion of Screen:</p> <p>1. Drag Handles Position Rectangle For Screen</p> 	<p>Choose one of the following three ways to define Portion of Tablet:</p> <p>1. Drag Handles Position Rectangle For Tablet</p> 																
<p>2. Select Area with Screen Cursor Click to Define Screen Area</p>	<p>2. Select Area with Tool Click to Define Tablet Area</p>																
<p>3. Enter Coordinates (in Pixels)</p> <table><tr><td>Top:</td><td><input type="text" value="0"/></td><td>Bottom:</td><td><input type="text" value="768"/></td></tr><tr><td>Left:</td><td><input type="text" value="0"/></td><td>Right:</td><td><input type="text" value="1366"/></td></tr></table>	Top:	<input type="text" value="0"/>	Bottom:	<input type="text" value="768"/>	Left:	<input type="text" value="0"/>	Right:	<input type="text" value="1366"/>	<p>3. Enter Coordinates (in Counts)</p> <table><tr><td>Top:</td><td><input type="text" value="0"/></td><td>Bottom:</td><td><input type="text" value="9500"/></td></tr><tr><td>Left:</td><td><input type="text" value="0"/></td><td>Right:</td><td><input type="text" value="15200"/></td></tr></table>	Top:	<input type="text" value="0"/>	Bottom:	<input type="text" value="9500"/>	Left:	<input type="text" value="0"/>	Right:	<input type="text" value="15200"/>
Top:	<input type="text" value="0"/>	Bottom:	<input type="text" value="768"/>														
Left:	<input type="text" value="0"/>	Right:	<input type="text" value="1366"/>														
Top:	<input type="text" value="0"/>	Bottom:	<input type="text" value="9500"/>														
Left:	<input type="text" value="0"/>	Right:	<input type="text" value="15200"/>														
<p>Message:</p> <div style="border: 1px solid gray; height: 40px;"></div>	<p>Message:</p> <div style="border: 1px solid gray; height: 40px;"></div>																
<p>Cancel OK</p>	<p>Cancel OK</p>																

The above screenshot is for descriptive purposes; it may not match your screen.

Map your device in mouse mode

In **Mouse** mode, you use the pen like a mouse. The cursor stays on the point that you left it when you pick up your pen, and you interact with your device like you interact with a mousepad or trackpad.

1. In Wacom Tablet Properties, select your **pen** from the **Tool** list, and then select the **Mapping** tab.
2. From **Mode**, select **Mouse**.
3. If desired, change the mouse settings.

Tip: The best way to decide how to adjust these settings is by moving the sliders and testing how they affect your screen cursor movement. **Mouse Acceleration** and **Mouse Speed** affect each other, so be sure to move them both to see how they work together.

- **Mouse Height:** Move the slider to adjust how high you have to lift up off the tablet in order to continue moving the cursor across the screen.
- **Mouse Acceleration:** Move the slider to adjust how far the screen cursor moves based on how quickly you are moving across the device.
- **Mouse Speed:** Move the slider to adjust how far the screen cursor moves as you move across the device.

 **CAUTION:** When you make changes to these settings, you are not changing corresponding settings in your computer's system settings. However, if you make changes to mouse settings in your computer's system settings, those changes may affect how your mouse works in **Mouse** mode.

Tablet active area mapping

The active area is the area on the tablet that you interact with by pen and touch, if touch is supported on your tablet. The active area might be indicated by a different color or by a pattern. The edges of the active area might be outlined or indicated with marks in the corners.

How does the tablet active area correspond to your monitors?

- If you have one monitor attached to your computer, the active area maps to your entire monitor.
- If you have multiple monitors attached to your computer, the active area maps to all monitors.

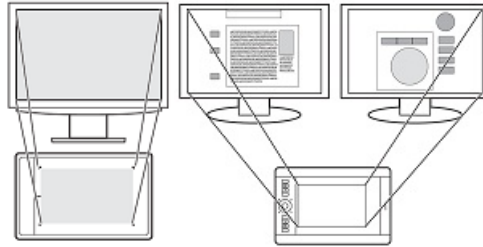

How does pen movement on the device correspond to what you see on the monitor?

- Wherever you place your pen on the tablet, the screen pointer moves to the corresponding point on the monitor.
- The screen pointer on your monitor follows your movement across the tablet surface.

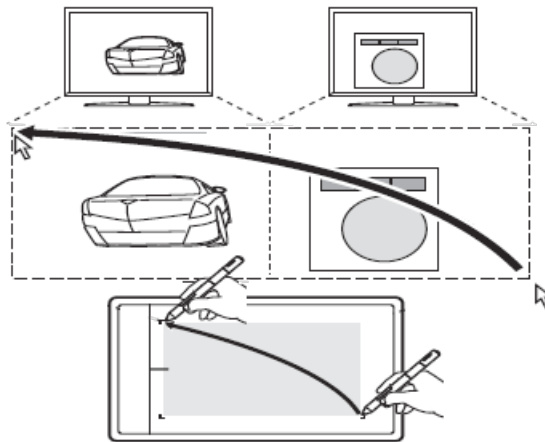

Tips for working in the tablet active area

- You can customize how the tablet active area maps to your monitors on the [Mapping](#) tab in Wacom Tablet Properties.
- You can toggle between working on all of your monitors at once to working on an individual monitor by using Display Toggle.
- If your device has touch functionality, you can also use gestures in the active area to perform specific functions, such as tapping twice to double-click an item. You can view gesture options on the **Touch** tab in Wacom Tablet Properties.

Switch between displays using Display Toggle

You can toggle between displays by using **Display Toggle** so that you can quickly switch between working on all of your monitors and working on an individual monitor. Display Toggle switches between the display that you set on the **Mapping** tab and each of your monitors one at a time.

1. Assign **Display Toggle** to one of your device's customizable components, like an [ExpressKey](#) or an [On-Screen Control](#).
2. Go to your computer's display properties menu and select **extend** so that you are using multiple monitors as one continuous display.
 - If you mirror or duplicate your monitors or only show on one monitor, Display Toggle is not available.

Now, when you engage the Display Toggle, you cycle between the display option set on the [Mapping](#) tab and each of your monitors.

Care for your device

Follow these care and maintenance tips to ensure optimum performance of your device.

Warning: Do not spill liquids onto your device or pen. They will fail if exposed to liquids.

- Clean your devices using an anti-static cloth or slightly damp cloth and light pressure.

 **WARNING:** Do not use alcohol or detergent.

- Do not wrap the cables around the device when storing it.
- Replace your pen nibs frequently to avoid scratching the surface with worn pen nibs.
- Avoid extremes in temperature.
- Do not disassemble the device or the pen, except to add a color ring to the pen. Taking apart the product voids your warranty.

Make sure to review the **Important Product Information** for additional safety precautions. You can find it in the [Wacom Desktop Center](#), if supported for your device, or from [Customer Support](#).

Technical Support

If you encounter an issue with your pen tablet or pen display, perform the recommended action in any error message that appears on your screen. If that does not resolve the issue, try the following:

- Review the Quick Start Guide and make sure that the tablet is set up correctly, including that all plugs and connectors are firmly in place.
- Check the User Help for information regarding the issue.
- Visit the [Wacom website](#) to view the product FAQs (Frequently Asked Questions) to see if any apply to your issue.
- Go to [Customer Support](#) to see if a new driver is available and install it.
- Test your device and tools.

If you tried these suggestions and still have an issue, contact [Customer Support](#). Please be near your computer with the following information available:

- The make and model of your computer and the version of your operating system.
- Which devices were connected to your computer when the issue occurred.
- The name and version of the software application that you were using when the issue occurred.
- What happened and what you were doing when the issue occurred.
- The exact wording of any error messages that appeared on your screen.
- How you tried to solve the problem.

Test the tablet

Turn on your computer. The tablet status LED should light. There may be a short delay before the device is ready to use.

If the LED does not light, try these tests to potentially fix the issue yourself.

1. Restart your computer.
2. Inspect the cables for damage.
3. Open your computer's device manager or system information menu and verify that the USB port that the device is plugged into is working properly.
4. Make sure the cables are securely connected to your device and to your computer.
5. If you are using a USB hub, make sure the hub is securely connected to your computer. If it is and your device still does not work, disconnect the device and plug it into a USB port that is on your computer instead.
6. If you are using a USB port on your computer, try connecting the device to a different USB port on your computer. If that does not work, try connecting the device to a USB port on another computer.
7. If you are using any other tools, such as the mouse, check to make sure that they function.

If these tests fail, you may have defective hardware. Contact [Customer Support](#) for help.

Test the ExpressKeys™ and Touch Ring

If your ExpressKeys™ or a Touch Ring do not work as you expect, check the assigned functions or reset them to their default conditions. See [Testing a pen or mouse](#) for more information on testing your pen tablet components.

1. Open [Wacom Tablet Properties](#) and click on the **About** button. In the dialog that appears, click **Diagnose...** The Diagnostics dialog shows dynamic information about the tablet, your tool(s), and appropriate information for touch-sensitive tablets.
2. If more than one pen tablet is connected to your system, select the one you are testing in the **Tablet Info** column.
3. Use the information shown in the dialog when testing your tablet and tools.

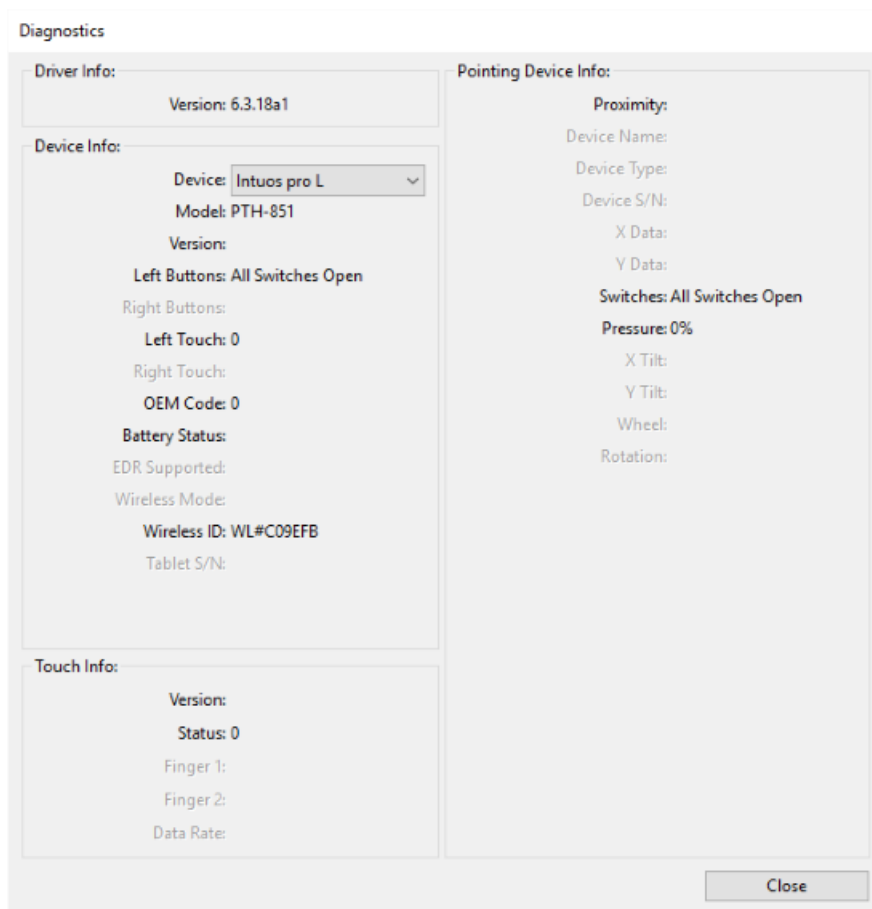

The above screenshot is for descriptive purposes; it may not match your screen.

Testing the ExpressKeys™

1. With the Diagnostics dialog open, observe the **Tablet Info** column as you test each ExpressKey. Be sure you have selected the tablet you are testing from the **Tablet Info** column.
2. Test the keys by pressing them one at a time. Each time you press a key, its number is shown next to the **Left Buttons** category.
3. When you are done, click the **Close** button.

Testing the Touch Ring

1. With the Diagnostics dialog box open, observe the **Tablet Info** column as you test the Touch Ring. Be sure you have

selected the tablet unit you are testing from the **Tablet Info** column.

2. For a Touch Ring, slide your finger around the entire circumference of the Touch Ring and watch the **Left Touch** number indicating your current finger position on the Touch Ring.
3. Press the Center Button to toggle between the four modes and note whether the corresponding LEDs illuminate. If any of the functions are set to Skip, the corresponding LED will be skipped in the toggle sequence.
4. When you are done, click on the **Close** button to exit the dialog.

If these tests fail, you may have defective hardware. See [Technical Support](#).

Important: Some applications can override and control the ExpressKey or Touch Ring functions. Consider closing any open applications except [Wacom Tablet Properties](#) when testing the Touch Ring. For details, see [Using integrated applications](#).

Test the pen

If your pen does not work properly, try these fixes first.

1. Go to the **Pen** tab in [Wacom Tablet Properties](#) and check that the settings assigned to the pen tip and pen buttons are what you expect.
2. If the assigned settings are as expected, restart your computer.
3. If restarting does not fix the issue, update your driver software.
4. If updating your driver does not fix the issue, **Reset settings** in the [Wacom Desktop Center](#).
5. If resetting does not fix the issue, diagnose issues using Wacom Tablet Properties.

Diagnose issues using Wacom Tablet Properties

- [Open Wacom Tablet Properties](#).
- If you have more than one device connected to your system, select the device you are using the pen with from the **Device** list.
- Click **About**, and then click **Diagnose**.

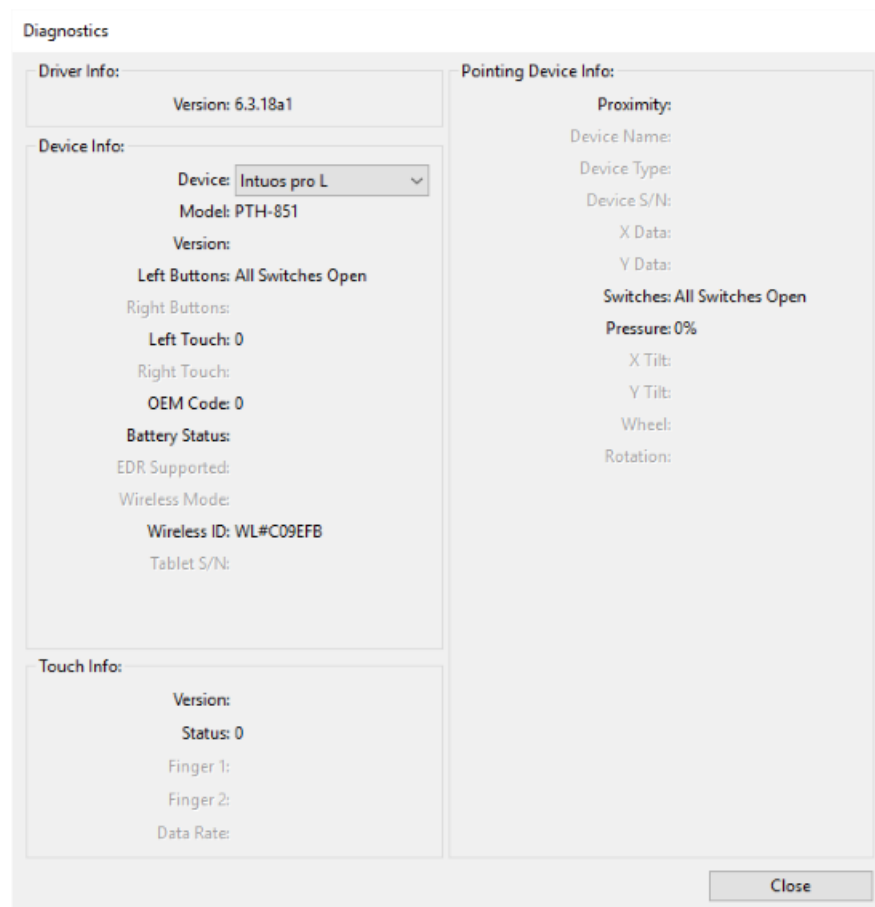

The above screenshot is for descriptive purposes, it may not match your screen.

Note: Your device might not have all of the options listed.

- Hold your pen within 10 mm (0.4 inch) of the surface of the device while watching the **Pointing Device Info**.
 - You should see a value appear after **Proximity**, **Device Name**, **Device Type**, and **Device S/N** (serial number).
- Move the pen along the surface of the device.
 - As you move the pen, the **X Data** and **Y Data** values should change.
- Press on the surface with the pen tip and then with the eraser.
 - As you are pressing, the **Switches** and **Pressure** values should change from approximately 0% to approximately 100% when you are pressing with full pressure.
- Press the tip, eraser, and each pen button, one at a time. When you are pressing each pen button, hold the pen tip slightly above the device surface.

⚠ Important: Pen features vary depending on which pen you have. Your pen may not have an eraser or any buttons.

- As you press each item, the **Switches** number should change to match these numbers:

- Pen tip = 1
- Pen button (***) = 3
- Pen button (**)= 2
- Pen button (*) = 2, 3
- Pen eraser = 1
- Airbrush tip = 1
- Airbrush pen button = 2
- Airbrush eraser = 1

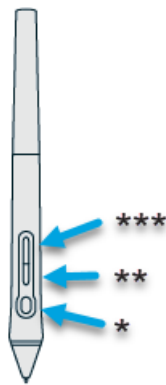

- Move the pen from a vertical position toward the right and then toward the left.
 - The **X Tilt** value should change to approximately +60 when you move to the right.
 - The **X Tilt** value should change to approximately -60 when you move to the left.
- Move the pen from a vertical position toward the bottom of the device and then toward the top of the device.
 - The **Y Tilt** value should change to approximately +60 when you move toward the bottom.
 - The **Y Tilt** value should change to approximately -60 when you move toward the top.
- If you are testing an Art Pen, place the pen tip on the surface of the device and slowly rotate the pen on its axis.
 - The **Rotation** value should change as you rotate the pen.
- If you are testing an Airbrush, move the fingerwheel forward and backward.
 - The **Wheel** value should decrease to approximately 0 when the fingerwheel is all the way forward.
 - The **Wheel** value should increase to approximately 1000 when the fingerwheel is all the way backward.

Glossary

Application-specific settings. Pen tablet tool and tablet settings that have been customized for individual applications. Application-specific settings are in effect whenever you use the application.

Aspect. The ratio between the vertical and horizontal dimension of the tablet or display.

Bluetooth. A method of wireless communication between devices.

Click force. The amount of force you must apply to the pen tip for a click to occur.

Digital Ink. Typically, handwritten content which has been created using a pen on a computer in the form of sketches, ink mark-up, or handwriting. The handwriting can be converted to typewritten text or used in its original format.

Display Toggle. A feature that allows you to work with your tablet on all displays or on one display at a time. Available only on multiple monitor systems.

Double-click assist. A feature that makes it easier to double-click by setting the size of the double-click distance.

Double-click distance. The maximum distance (in screen pixels) that the screen cursor can move between clicks and still be accepted as a double-click. Increasing the double-click distance makes double-clicking easier, but may cause a delay in brush strokes in some graphics applications.

Double-click speed. The maximum time that can pass between clicks and still be accepted as a double-click.

Eraser-aware application. A software application that has built-in support for the pen eraser. These applications take advantage of the eraser in different ways, depending on what makes sense for the application.

Expand. A motion used when navigating with touch. Touch the tablet surface with two fingers spaced closely together, then move your fingers apart.

ExpressKeys™. The customizable component buttons located on your pen tablet.

Fingerwheel. The control wheel on the optional Airbrush.

Modifier. Modifier keys include Shift, Alt, and Ctrl for Windows, or Shift, Control, Command, and Option for Mac. You can customize your tool buttons or ExpressKeys™ to simulate a modifier key.

Nib. The replaceable pen tip.

Pairing. A method of creating a virtual cable (Bluetooth) link between two devices.

Pan. A motion used when navigating with touch. Touch the tablet surface with your fingers and move them in the same direction.

Pen input. A method of controlling a computer using the pen.

Pinch. A motion used when navigating with touch. Touch the tablet with two fingers spaced slightly apart, then move or 'pinch' your fingers together on the tablet surface.

Pixel. The smallest unit of measure on your display screen.

Pressure sensitive. A quality of the Wacom pen tip and eraser that senses the amount of pressure being applied. This is used to create natural-looking pen, brush, and eraser strokes in applications that are pressure-sensitive.

Pressure-sensitive application. Any application that supports pressure-sensitive input.

Proximity. The height above the tablet active area where pen detection occurs.

Rotate. A motion used when navigating with touch. Touch the tablet with two fingers spaced slightly apart and rotate them in a

circular fashion, move them in opposing directions, or hold one finger stationary and track your other finger around the stationary finger.

Swipe. A motion used when navigating with touch. Touch the tablet surface with three, four, or five fingers and sweep them quickly across the tablet in the same direction.

Tap. A motion used when navigating with touch. Touch and lift a single finger (or multiple fingers, depending on the gesture) from the tablet.

Tilt-sensitive. A quality of the pen tip and eraser that senses the amount of tilt between the tool and the tablet. This is used to create natural-looking pen, brush, and eraser strokes in applications that are tilt-sensitive.

Touch. A method of interacting with a computer using only your fingers on the tablet. May also be referred to as touch input.

Touch Ring. The customizable control ring located on your pen tablet.

Touch Strips. The customizable control strips located on the back of the Cintiq 22.

Touch sensor. The navigation area of your pen tablet where touch is detected. The touch sensor resides within the active area, and does not accept pen input.

Track. A motion used when navigating with touch. Touch and move a single finger across the tablet surface.

Wacom Link adaptor Adapter for the MobileStudio Pro which converts USB-C connection allowing Desktop Mode to function on machines without a USB-C port.

Order parts and accessories

To purchase parts and accessories for your device, go to the [Wacom Store](#).

You may also contact your local dealer, distributor, or [Customer Support](#) for your region.

Note: Some parts and accessories may not be available in all regions.

Privacy

At Wacom, we value your Privacy. We use Google Analytics to collect basic information about browsing to improve our User Help.

Please see our [Privacy Policy](#) for more information.

Trademarks

Copyright © 2018 Wacom Co., Ltd.

All rights reserved. Wacom, Intuos, Cintiq, and their respective logos are trademarks and/or registered trademarks of Wacom Co., Ltd.

No part of this information may be reproduced except for your express personal use.

Wacom makes reasonable efforts to provide current and accurate information. However, Wacom reserves the right to change any specifications and product configurations at its discretion, without prior notice and without obligation to include such changes.

Illustrator and Photoshop are either registered trademarks or trademarks of Adobe Systems Incorporated in the United States and/or other countries. Microsoft and Windows are either registered trademarks or trademarks of Microsoft Corporation in the United States and/or other countries. Apple, the Apple logo, and Mac are registered trademarks of Apple, Inc., registered in the U.S. and other countries. ExpressKey is a trademark of Ginsan Industries, Inc., and is used with permission.

Many Wacom devices incorporate High Definition Multimedia Interface (HDMI) technology. HDMI, the HDMI logo, and High Definition Multimedia Interface are trademarks or registered trademarks of HDMI Licensing LLC.

All additional company and product names mentioned in this documentation may be trademarked and/or registered as trademarks. Mention of third-party products is for information purposes only and constitutes neither an endorsement nor a recommendation. Wacom assumes no responsibility with regard to the performance or use of these products.