

Nokia Body+

Weight & Body Composition - Daily Report Installation and Operating Instructions



Table of Contents

Minimum Requirements.....	4
Internet access	4
Smartphone or device	4
OS version.....	4
Nokia Health Mate® app version	4
Nokia Body+ Description	5
Overview	5
Box contents.....	5
Product description	6
Scales screens description.....	6
Setting Up the Nokia Body+	8
Installing the Nokia Health Mate® app.....	8
Installing your Nokia Body+	8
Customizing Your Nokia Body+.....	21
Changing the configuration of your Nokia Body+	21
Changing the settings of your Nokia Body+.....	24
Using Your Nokia Body+	31
Tracking your weight and body composition.....	31
Checking the weather.....	39
Using Baby mode.....	40
Using Pregnancy Tracker	42
Linking Your Account to Partner Apps	44
Linking your account to MyFitnessPal	44
Linking your account to Nike+	45
Syncing Your Data	48
Dissociating Your Nokia Body+	49
Performing a Factory Reset of Your Nokia Body+	51
Cleaning and Maintenance	52
Cleaning your Nokia Body+	52

Changing the batteries.....	52
Installing the carpet feet.....	53
Updating your Nokia Body+	53
Technology Description.....	56
Weight	56
Body Composition	56
Specifications	57
User Guide Copyright	59
Legal Notice	59
Personal Data.....	59
Safety Instructions	61
Use and Storage	61
Location	61
Service and Maintenance	61
Document Release Overview.....	62
Warranty	63
Regulatory Statements	64

Minimum Requirements

Internet access

Access to the Internet is required to:

- Download the Nokia Health Mate® app,
- Set up your Nokia Body+,
- Upgrade your product whenever an update is available.

For more details, refer to [“Specifications” on page 57](#). We recommend using the app on a device connected to the Internet to enjoy all features.

Smartphone or device

An iOS device or an Android device (with operational Bluetooth and Wi-Fi or 3G/4G) is required to:

- Set up your Nokia Body+,
- Retrieve data from your Nokia Body+,
- Access specific functions of your Nokia Body+.

Bluetooth Low Energy (BLE) compatibility is recommended to install your Nokia Body Cardio. For more details, refer to [“Specifications” on page 57](#).

OS version

You need iOS 8 or above to install and run the Nokia Health Mate® App on an iOS device.

You need Android 2.3.3 or above to install and run the Nokia Health Mate® App on an Android device.

Nokia Health Mate® app version

We recommend that you use the latest available version of the Nokia Health Mate® app to have all the latest features available.

Nokia Body+ Description

Overview

The Nokia Body+ allows you to easily track your weight and monitor your progress. Additionally, it calculates your fat mass, muscle mass, bone mass and water mass by bioelectric impedance to inform you about your body composition.

Of course that's not all your Nokia Body+ does. If you activate the Weather screen, you also get your daily weather report everytime you weigh in.

Because the Nokia Body+ is a connected scale, its true potential is achieved when you use it along with the Nokia Health Mate® app. Beside allowing you to install your scale, the Nokia Health Mate® app allows you to customize its display, to set a weight goal, and to check the entire history of your weight data.

Thanks to its in-app activity tracking feature and the numerous partner apps you can connect it to, the Nokia Health Mate® app helps you reach your health goals faster by helping you track your activity and check your calorie balance.

Box contents

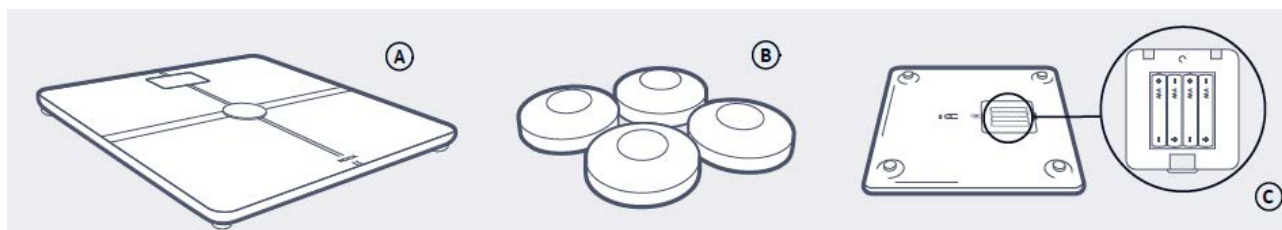

(A) Nokia Body+

(B) Carpet feet

(C) Alkaline cells already inserted

Product description

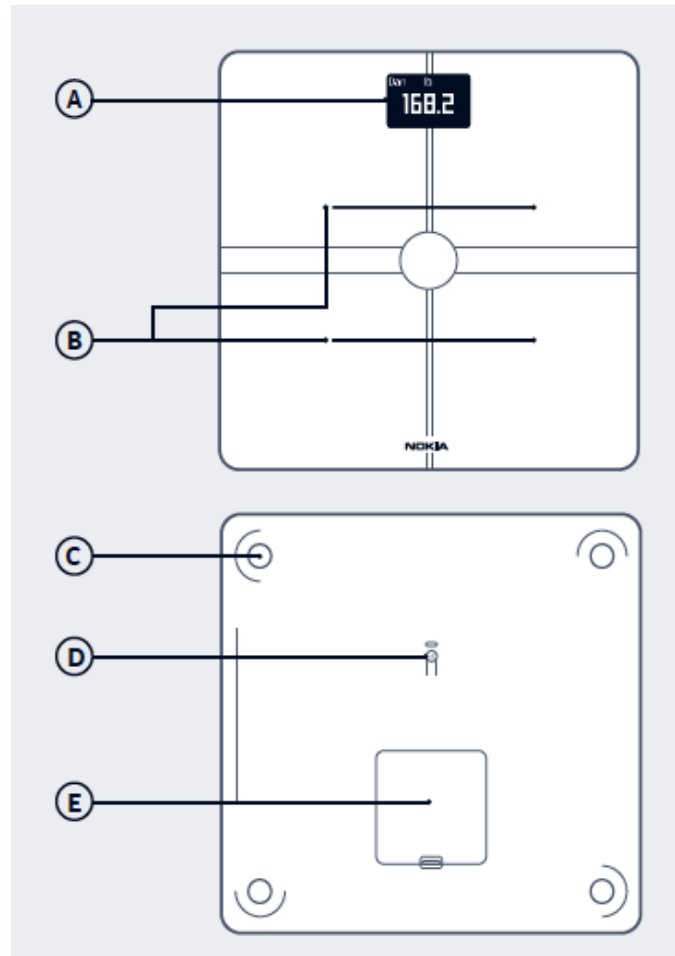

(A) Display

(B) Electrodes

(C) Feet

(D) Pairing and units button (E) Battery compartment

Scales screens description

You can select a number of screens to be displayed on your Nokia Body+:

- **Weight:** Displays your weight. This screen cannot be disabled.
- **Fat mass:** Displays your percentage of fat mass.
- **Water:** Displays your percentage of water.
- **Bone mass:** Displays the weight of your bones.
- **Muscle mass:** Displays the weight of your muscles.
- **Weather**¹: Displays the weather for the day.
- **Weight Trend**¹: Displays a graph with your last 8 weight measurements.
- **Steps**^{1, 2}: Displays the number of steps you did the previous day.
- **NikeFuel**^{1, 3}: Displays the amount of NikeFuel you earned the previous day.

You can disable or change the order of these screens as you like after you install your Nokia Body+. Otherwise, they will appear in the default order. Refer to [“Changing the screen order” on page 25](#) for more information.

¹ This screen can only be used if you set up your Nokia Body+ in Wi-Fi.

² You either need to own a Nokia® tracker, or to use the in-app tracking of the Nokia Health Mate® app to display your number of steps on this screen. If you don't have a Nokia® tracker, tap on Activity in your Dashboard in the Nokia Health Mate® app and tap **Activate now**. Your mobile device will then start tracking your steps.

³ You need to have a Nike+ account to see the amount of NikeFuel you have on this screen.

Setting Up the Nokia Body+

Installing the Nokia Health Mate® app

If the Nokia Health Mate® app is not already installed on your device, perform the following steps:

1. Type healthapp.nokia.com in your device's web browser.
2. Tap **Download on the App Store**.
3. Tap **GET**.
The installation process starts.

Installing your Nokia Body+

Overview

Installing your Nokia Body+ in Wi-Fi gives you access to all the features and screens available. Installing your Nokia Body+ in Bluetooth limits the features and screens available. For example, you can't use the Weather screen and the Steps screen, as they require access to the Internet.

You can change the configuration of your Nokia Body+ anytime you want. Refer to [“Changing the configuration of your Nokia Body+” on page 21](#) for more information.

Note that once you've installed your Nokia Body+ on your account, all the users of the account can use it. You are also free to install it on various account. There is, however, a limit of eight users per scale at the moment.

Installing your Nokia Body+ without an existing account

Refer to “Installing your Nokia Body+ with an existing account” on page 15 if you already have a Nokia® account.

1. Pull the tab out of the battery compartment if it's the first time you install your Nokia Body+.
2. Press and hold the side button for three seconds.

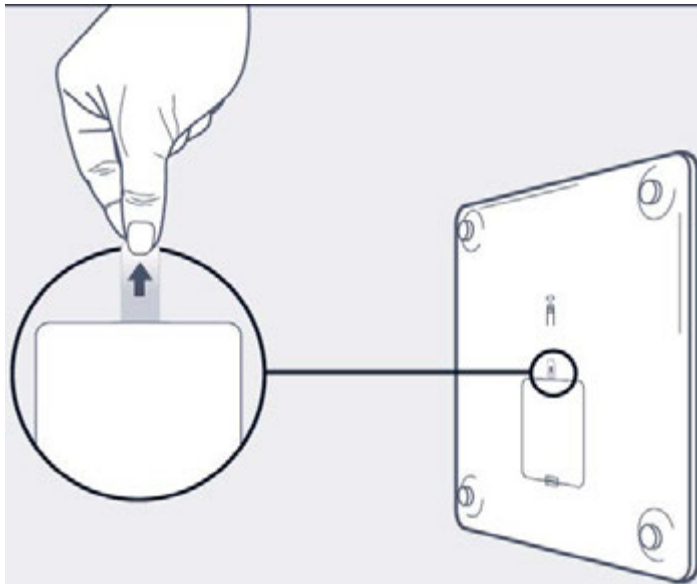

The scale displays healthapp.nokia.com.

3. Open the Nokia Health Mate® app.
4. Tap **Get started**.

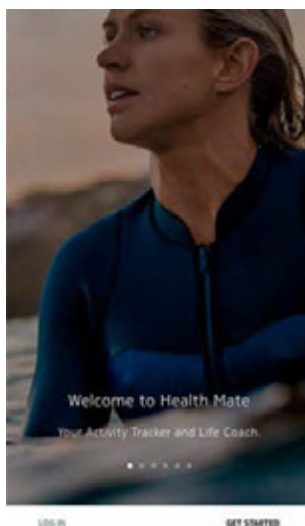

5. Tap **I'm setting up my device.**



6. Tap **Scales.**



7. Tap **Body+**.

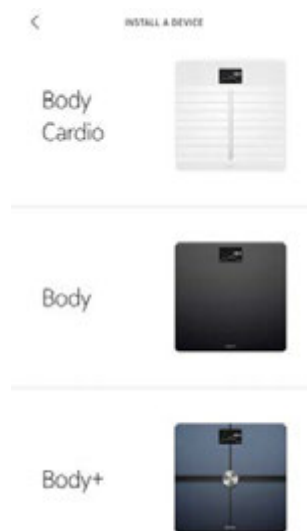

8. Tap **Install**.



9. Press the pairing button at the back of the scale for three seconds and tap **Next**.

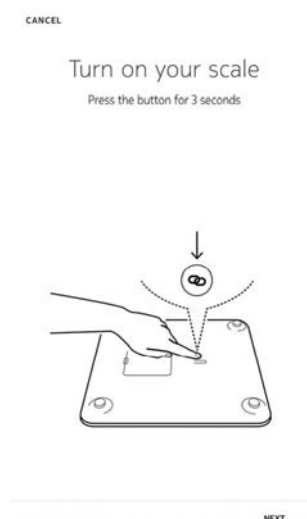

It may take up to a minute for your scale to be detected by your mobile device.

If your Nokia Body+ is not displayed in the list, go to the Bluetooth settings of your device and pair it from there. It should now appear in the Nokia Health Mate® app.

10. Tap **Next**.

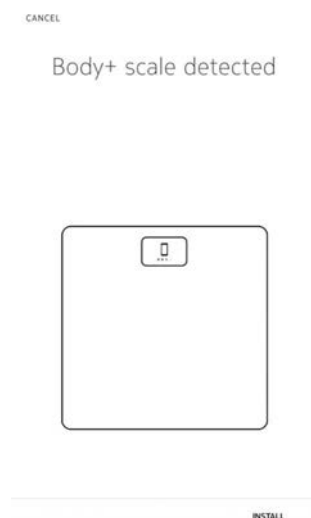

11. Tap **Pair** twice.

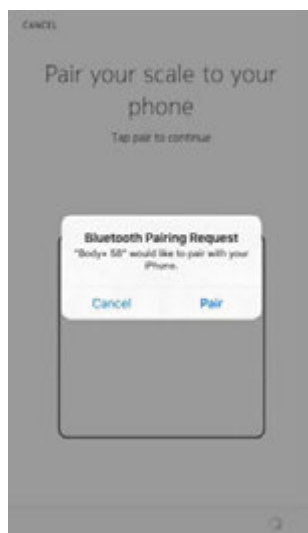

12. Tap **Next**.



13. Enter your email address, password, and then confirm your password. Tap **Next**.
14. Enter your first name, surname (last name) and birthday. Tap **Next**.
15. Select your gender and enter your current height and weight. Tap **Create**.
This information is necessary for the calculation of your BMI. It also allows your Nokia Body+ to recognize you based on your weight the first time you weigh in.
16. If you want your scale to sync in Wi-Fi once it's installed, perform the following steps:
 - a. Tap **Quick setup** to use the same Wi-Fi network as your mobile device or **Setup another network** to use another one.



b. Tap Allow.

You will need to update the Wi-Fi configuration if you change the network name or password. Refer to [“Changing the configuration of your Nokia Body+”](#) on page 21 for more information.

17. If you want your scale to sync in Bluetooth only once it's installed, tap **I don't have a Wi-Fi Network**.
18. Tap **Done**.



The Nokia Health Mate® now prompts you to select your target weight. Tap **Cancel** if you don't want to set a weight goal. You can set one later on if you change your mind. Refer to [“Changing your weight goal”](#) on page 33 for more information.

Installing your Nokia Body+ with an existing account

1. Pull the tab out of the battery compartment if it's the first time you install your Nokia Body+.
2. Press and hold the side button for three seconds.

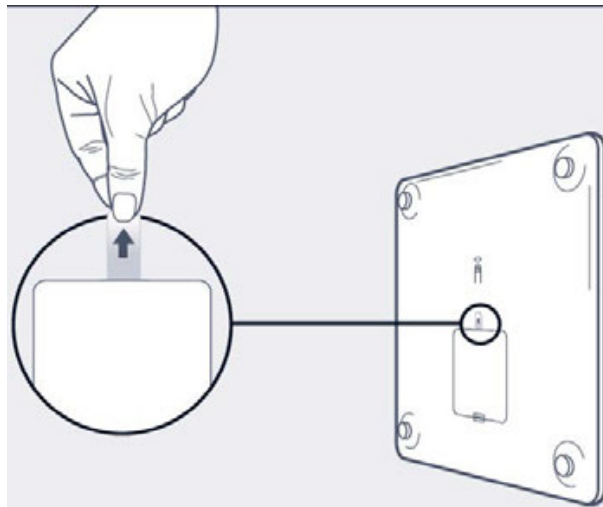

The scale displays healthapp.nokia.com.

3. Open the Nokia Health Mate® app.
4. Go to **My devices**.
5. Tap **+**.

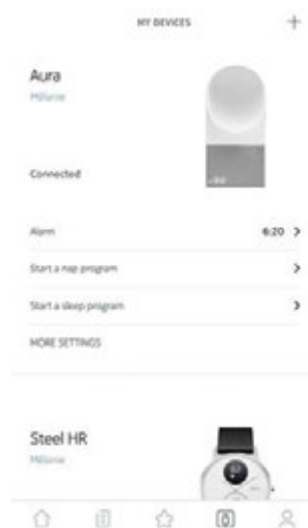

6. Tap **Scales**.



7. Tap **Body+**.

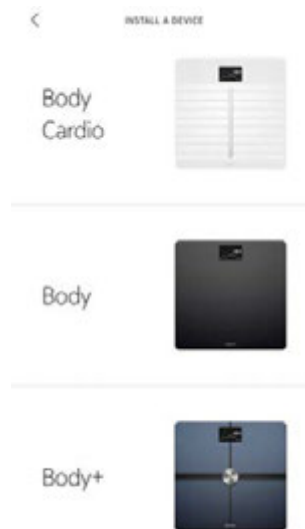

8. Tap **Install**.



9. Press the pairing button at the back of the scale for three seconds and tap **Next**.

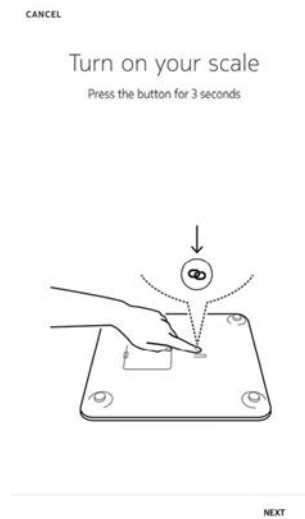

10. Tap **Next**.

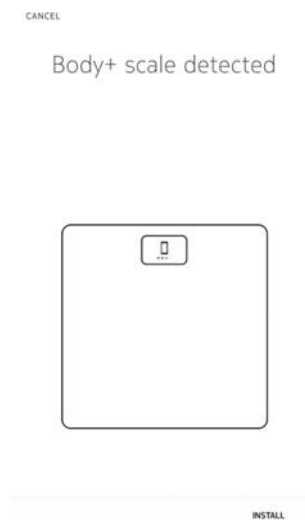

11. Tap **Pair** twice.

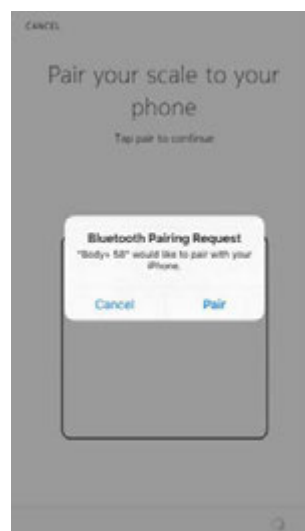

12. Tap **Next**.



13. If you want your scale to sync in Wi-Fi once it's installed, perform the following steps:

- a. Tap **Quick setup** to use the same Wi-Fi network as your mobile device or **Setup another network** to use another one.



b. Tap **Allow**.

You will need to update the Wi-Fi configuration if you change the network name or password. Refer to [“Changing the configuration of your Nokia Body+”](#) on page 21 for more information.

14. If you want your scale to sync in Bluetooth only once it's installed, tap **I don't have a Wi-Fi Network**.

15. Tap **Done**.



The Nokia Health Mate® now prompts you to select your target weight.

Selecting your weight goal

To select your weight goal, perform the following steps:

1. Tap and slide up or down to select your target weight.

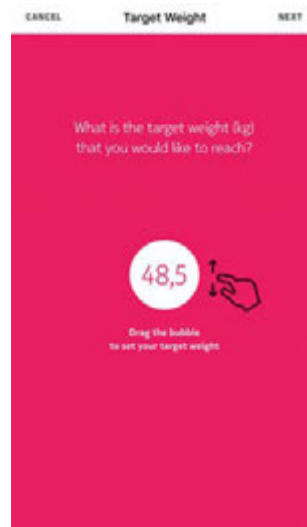

2. Tap **Next**.
3. Tap and slide up or down to select the pace at which you want to achieve your weight goal.

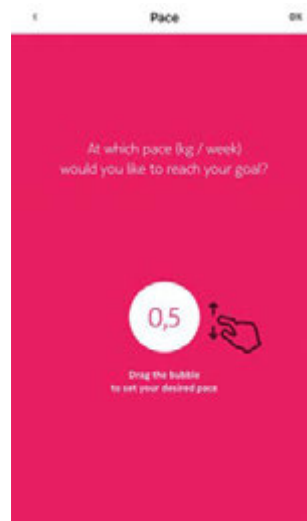

4. Tap **OK**.

Changing the configuration of your Nokia Body+

You may need to change the configuration of your Nokia Body+:

- If you want to use a different Wi-Fi network,
- If you've changed the name or password of the Wi-Fi network you use,
- If you want to switch from a Bluetooth configuration to a Wi-Fi configuration,
- If you want to switch from a Wi-Fi configuration to a Bluetooth configuration.

To change your configuration, perform the following steps:

1. Open the Nokia Health Mate® app.
2. Go to **My devices**.
3. Tap **Body+**.

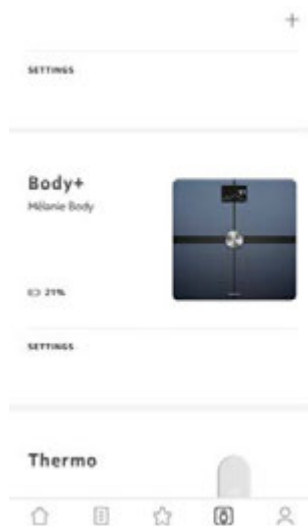

4. Tap **Update Wi-Fi Configuration**.

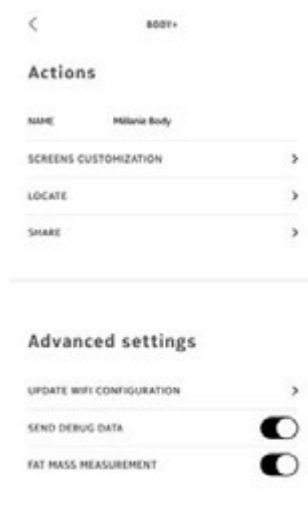

5. Press the pairing button at the back of the scale and tap **Next**.

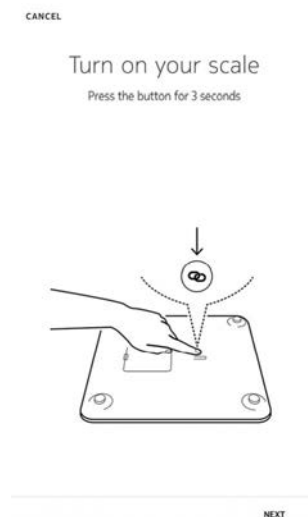

6. Tap **Next**.



7. To switch to a Wi-Fi configuration or to update the Wi-Fi network:
a. Tap **Quick setup** to use the same Wi-Fi network as your mobile device or **Setup another network** to use another one.



b. Tap **Allow**.

8. To switch to a Bluetooth configuration, tap **I don't have a Wi-Fi Network**.

9. Tap **Done**.

You're all set!

Enjoy your new Body+ scale.



DONE

Changing the settings of your Nokia Body+

Changing the weight unit

You have the choice between three weight units: kilogram (kg), stone (stlb) and pound (lb). To change the units on your Nokia Body+, perform the following steps:

1. Press the button at the back of your Nokia Body+.
2. Press the button on the side of your Nokia Body+.
3. Check the screen of your scale to view the unit currently selected.
4. Press the button again to move the arrow to the correct unit.
The unit change is confirmed a few seconds after you stop pressing the button.

Changing the temperature unit

While you can change the weight unit directly from your Nokia Body+, the temperature unit (used in the Weather screen) can only be changed from the Nokia Health Mate® app. By default, the temperature unit is based on the language of the app. To change the temperature unit, perform the following steps:

1. Open the Nokia Health Mate® app.
2. Go to **Settings**.
3. Tap **Units**.

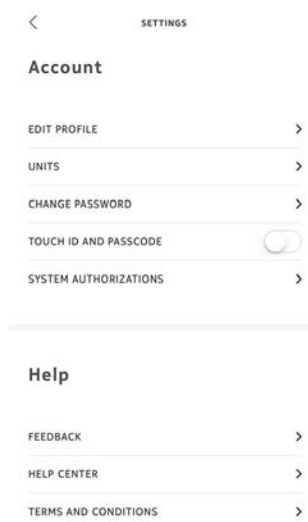

4. Select the temperature unit you want.
You can also change the weight unit from this screen but it will only affect the display in the Nokia Health Mate® app. The weight unit on the Nokia Body+ can only be changed from the scale itself. Refer to [“Changing the weight unit” on page 24](#) for more information.
5. Tap the back button to confirm.
You will need to weigh in once more before the change is taken into account on your scale.

Changing the screen order

You can change the order of the screens of your Nokia Body+, for example if you want to display the Weather screen first. To do so, perform the following steps:

1. Open the Nokia Health Mate® app.
2. Go to **My devices**.
3. Tap **Body+**.

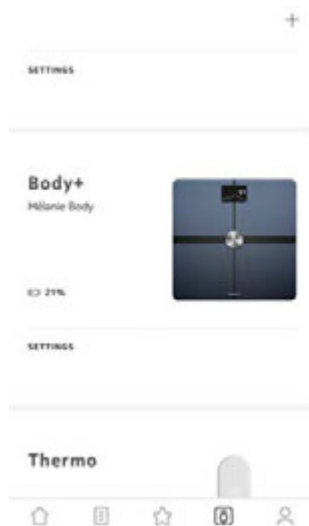

4. Tap **Screens customization**.

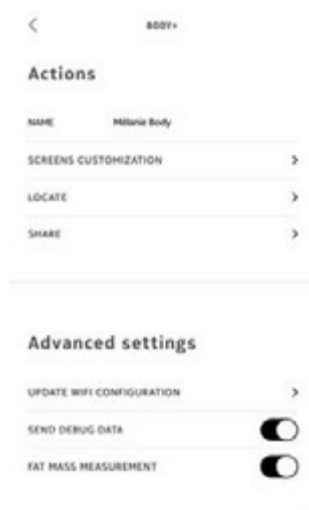

5. Tap the user profile for which you want to change the screen order.
6. Select the screens you want to display:

- Tap the blue circles on the left to hide a screen.
- Tap the empty circles on the left to display a screen.

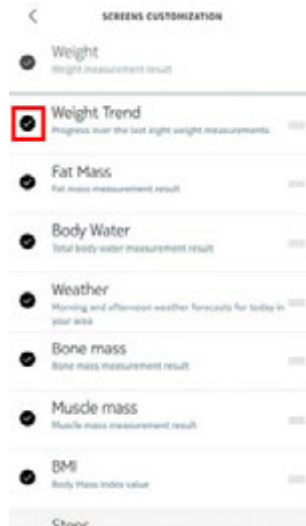

7. Tap and hold the icon on the right to drag a screen up or down.

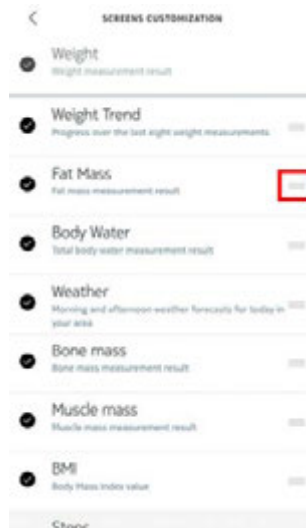

8. Tap the back button to confirm.

9. Weigh yourself once to synchronize your Nokia Body+ with your app and finalize the change.

The change will take effect upon your next weigh-in.

Changing the location of your scale

The location of your scale is used to provide you with the correct weather forecast if you have activated the Weather screen. It is based on your IP address but it is not always accurate. If the preset location of your scale happens to be incorrect, you are free to change it anytime you want. To do so, perform the following steps:

1. Open the Nokia Health Mate® app.
2. Go to **My devices**.
3. Tap **Body+**.

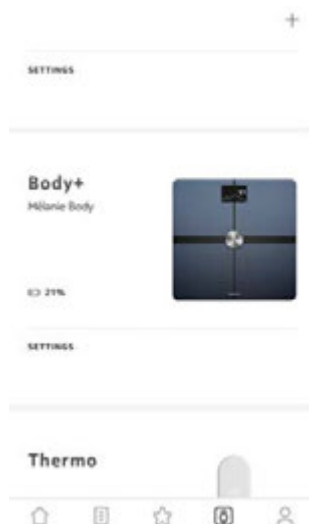

4. Tap **Location of your scale**.

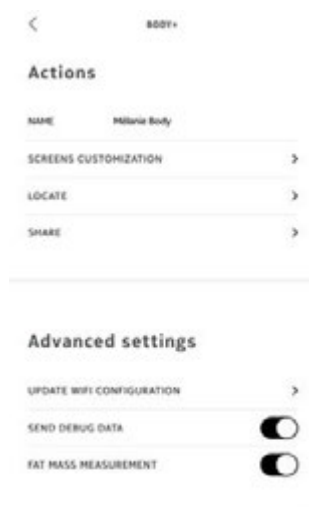

5. Enter the correct location of your scale and tap **OK**.



Disabling body composition measurements

You can disable body composition measurements (fat mass, muscle mass, bone mass and water mass) if you choose to. This is recommended for pregnant women and mandatory for anyone wearing a pacemaker.

The body composition measurements, including fat mass, muscle mass, bone mass and hydration, should not be used by people wearing a pacemaker. Users with any other internal medical device should not use these functions of the Nokia Body+ scale without consulting a medical professional.

To disable these measurements, perform the following steps:

1. Open the Nokia Health Mate® app.
2. Go to **My devices**.
3. Tap **Body+**.

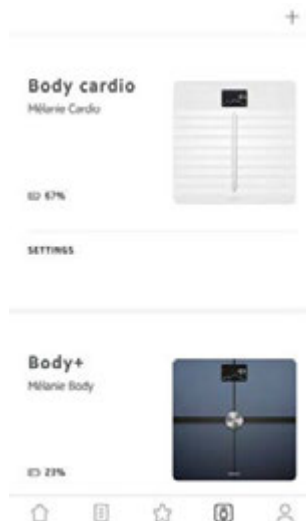

4. Tap **Fat mass measurement**.

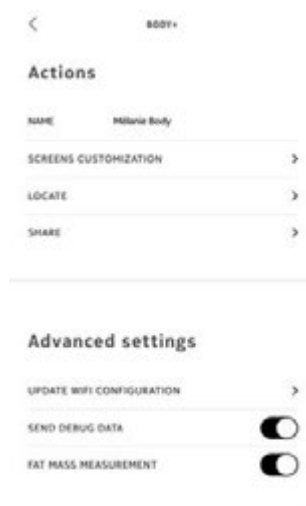

5. Tap the back button to confirm.

Using the Athlete mode

Athletes generally have a different body type which requires a specific fat mass calculation algorithm. If you work out more than 8 hours a week and have a resting heart rate below 60 bpm, you may need to use the Athlete mode. To do so, perform the following steps:

1. Open the Nokia Health Mate® app.
2. Go to **Profile**.
3. Tap **Settings**.



4. Tap **Athlete**.



Tracking your weight and body composition

Overview

The Nokia Body+ allows you to track your weight and lets you see how your weight trend changes over time. Beside your weight, it also allows you to check your body composition (fat mass, muscle mass, bone mass and water mass) which gives you a better idea of your level of fitness.

Make sure you follow the recommendations below to get accurate and representative weight measurements:

- Make sure you always weigh yourself around the same time to improve the consistency of your measurements.
- Wait five seconds before weighing yourself if you have just moved your scale.
- If your scale is on a carpet, make sure you're using the carpet feet. Refer to "" on [page 52](#) for more information.

Weighing yourself

Thanks to the Position Control™ technology, getting an accurate weight measurement has never been easier. If your weight is not properly distributed on your Nokia Body+, arrows are displayed on the scale to indicate in which direction you should lean to stabilize your weight.



If several users have a similar weight, the following screen can be displayed:



Simply lean left or right to select the correct name. Your measurements will then be affected to the correct user.

If you want to get information regarding your body composition as well, make sure that:

- Body composition measurements are enabled. Refer to [“Disabling body composition measurements” on page 28](#) for more information.
- All the body composition screens are enabled. Refer to [“Changing the screen order” on page 25](#) for more information.
- You step on the scale barefoot.
- You stay as still as possible during the measurement.
- You are recognized by your Nokia Body+, with your name appearing on the screen display.

Retrieving your weight data

As soon as you weigh yourself, your weight is displayed on the display of your scale. If you’ve activated the Weight Trend screen, you’ll also see a graph showing your eight last measurements as well as the difference between the latest measurement and the previous one. Refer to [“Changing the screen order” on page 25](#) for more information.

To see detailed graphs about your weight and body composition, and see your full history, you have to check your data on the Nokia Health Mate® app.

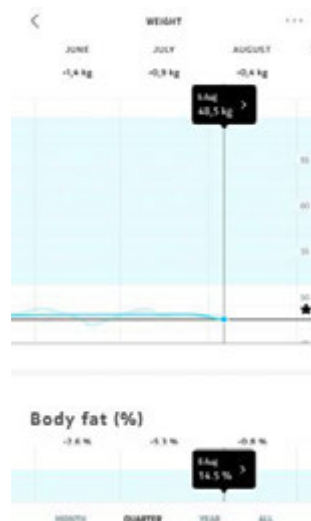

You can access your graphs:

- By tapping the Weight widget on your Dashboard.
- By tapping any weight measurement item in your Timeline.

Once you’re viewing the weight graph, you can view your body composition graphs and your BMI graph.

Changing your weight goal

To change your weight goal, perform the following steps:

1. Open the Nokia Health Mate® app.
2. Select a weight measurement in the Timeline.



3. Tap the three dots at the top right of the screen.

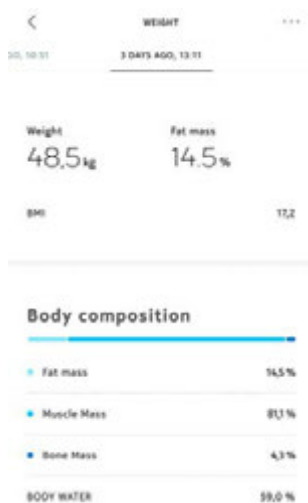

4. Tap **Set your target weight**.

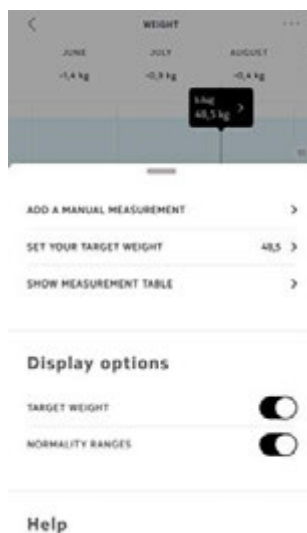

5. Tap and slide up or down to select your target weight.

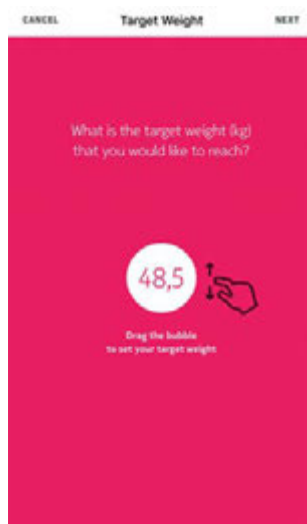

6. Tap **Next**.

7. Tap and slide up or down to select the pace at which you want to achieve your weight goal.

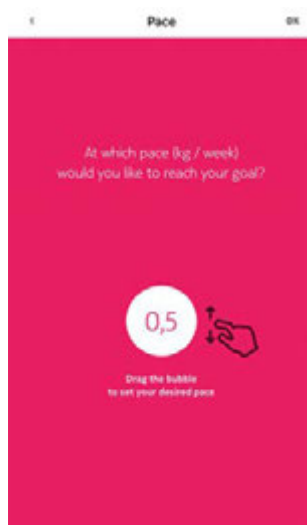

8. Tap **OK**.

Retrieving unknown measurements

If your Nokia Body+ doesn't recognize you when you weigh in, your weight measurements will be listed as unknown measurements. To assign them to a user, perform the following steps:

1. Open the Nokia Health Mate® app.
2. Go to **My devices**.



3. Select the **Unknown measurement**.



4. Tap the user you want to assign the measurement to.



Your measurements are now assigned to the correct user. Your Nokia Body+ will also be able to automatically assign your measurements the next time you weigh in.

Setting reminders

The Nokia Health Mate® app allows you to set reminders to make sure you weigh yourself regularly. To do so, perform the following steps:

1. Open the Nokia Health Mate® app.
2. Go to **Profile**.
3. Tap **Add**.



4. Select the type of reminder you want to set.

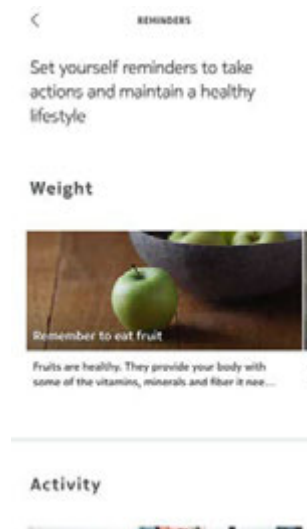

5. Select the time and recurrence of the reminder.

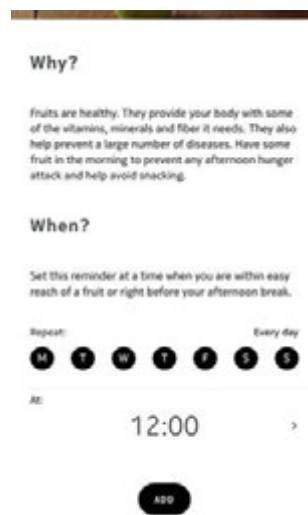

6. Tap **Add**.

Checking the weather

Overview

You can check the local weather forecast for the day directly on your Nokia Body+ if the following conditions are met:

- Your Nokia Body+ is set up in Wi-Fi. Refer to [“Changing the configuration of your Nokia Body+” on page 21](#) for more information on how to switch to a Wi-Fi configuration.
- The Weather screen is enabled. Refer to [“Changing the screen order” on page 25](#) for more information.

Retrieving weather information

All you have to do to retrieve weather information on your Nokia Body+ is to step on the scale and wait for the Weather screen to be displayed.

The Weather screen provides you with information about the average weather and temperature for the morning (between 6:00 AM and 12:00 PM) and for the afternoon (between 12:00 PM and 9:00 PM).



If you weigh yourself in the morning, the data of the day is displayed. If you weigh after 7:00 PM, the data of the next day is displayed.

Using Baby mode

Baby mode allows you to find out the weight of your baby by weighing yourself on the scale while holding your baby. To use this mode, you must create a profile for your baby in the Nokia Health Mate® app. Then enter the height and weight of your baby and weigh yourself while holding your baby in your arms. The weight of your baby will be automatically detected by the scale.

Important: your baby must weigh between 7 and 33 lbs (3 and 15 kg) to be detected by the scale. As Baby mode is enabled by default on the Nokia Body Cardio, you do not need to enable it in the Health Mate® app.

Follow the steps below to use Baby mode:

1. Create a profile for your baby in the Nokia Health Mate® app.
2. Enter the height and weight of your baby.
3. Weigh yourself on your own.
Your weight will be displayed on the screen of the Nokia Body Cardio.



4. Weigh yourself with your baby (within 5 minutes of first weighing yourself).
The scale will display your weight plus your baby's weight, followed by the weight of your baby on its own.

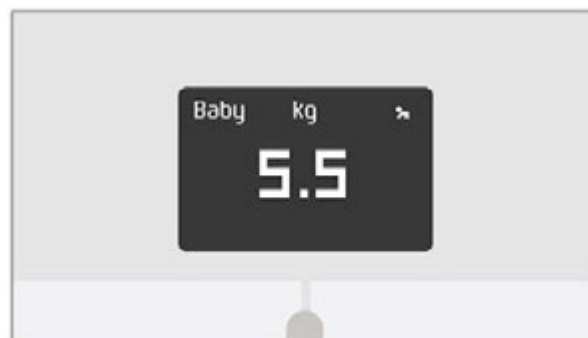
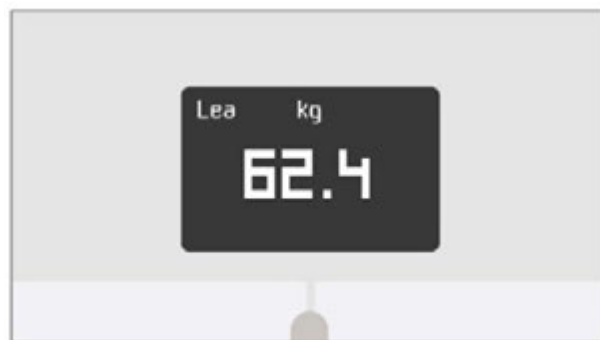

For best results, we recommend you to weigh yourself when your baby is calm.

Note: you can use Baby mode for several members of your family. For example, you may wish to add a profile for your baby to your account or create a separate account for your baby. Please note that you can add up to 8 users to your Nokia® account.

Using Pregnancy Tracker

Pregnancy Tracker provides an enriched Health Mate experience for pregnant women, offering advice, tips, and easy weight tracking throughout pregnancy.

Pregnant women will receive the following information on a weekly basis in their Health Mate Timeline:

- an overview of the week with the current stage of pregnancy and cumulative weight gain, along with how it compares with your personalized recommendations.
- health-related and obstetrician-reviewed information relevant to the current week of pregnancy.

Activating Pregnancy Tracker

Pregnancy Tracker can be activated by any woman at any time during pregnancy. To do so, perform the following steps:

1. Open the Nokia Health Mate® app.
2. Go to **Wellness Programs**.
3. Tap **Learn more**.

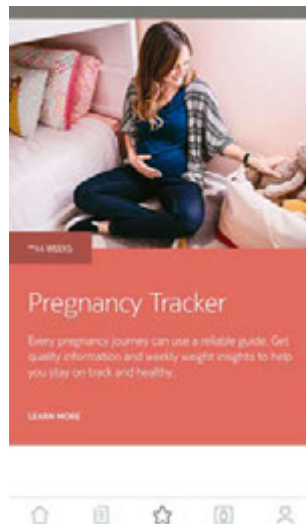

4. Tap **Join**.



Pregnancy Tracker

Every pregnancy journey can use a reliable guide. Get quality information and weekly weight insights to help you stay on track and healthy.

**ABOUT THE PROGRAM

Big changes are underway! The Baby on Board program offers well-timed advice, tips, and easy weight tracking throughout your entire pregnancy journey. Each week you'll get obstetrician-reviewed

FREE
**44 WEEKS

JOIN

Linking your account to MyFitnessPal

Overview

When you monitor your weight, it can also be useful to monitor your calorie intake with apps such as MyFitnessPal to help you reach your weight goal.

Once you link both accounts, your Nokia® account will be able to retrieve your daily calorie intake from MyFitnessPal. You can then check the MyFitnessPal widget from your Dashboard to see your calorie balance.

MyFitnessPal can also retrieve information from your Nokia® account: your weight and your calorie outtake.

Your calorie outtake is based on any activity data coming from a Nokia® activity tracker or the in-app tracking feature of the Nokia Health Mate® app. Note that tracking your activity can be a great way to help you achieve your weight goal.

Connecting to MyFitnessPal

To connect your Nokia® account to your MyFitnessPal account, perform the following steps:

1. Open the Nokia Health Mate® app.
2. Tap **Profile**.
3. Tap **MyFitnessPal**.

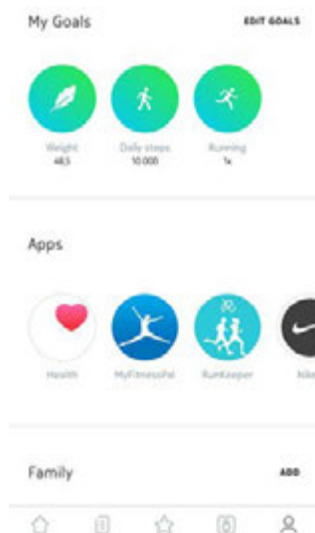

4. Tap **Open**.

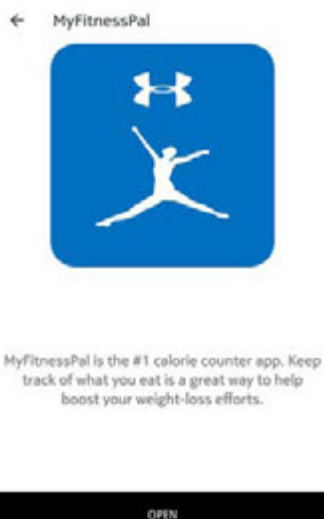

5. Log in to your MyFitnessPal account.

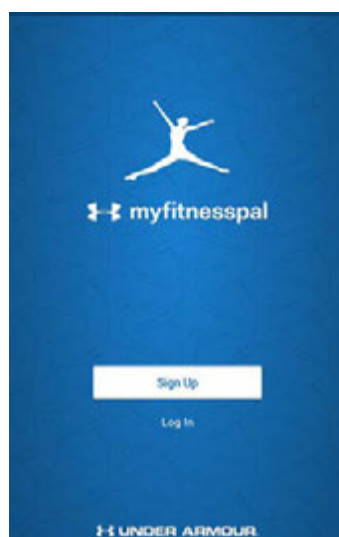

You can unlink your MyFitnessPal account and your Nokia® account anytime you want from your Profile.

Linking your account to Nike+

Overview

If you have a Nike+ account, you can start the day by seeing your NikeFuel of the previous day displayed on your Nokia Body+ and in the Nokia Health Mate® app thanks to the Nike+ integration.

Only your NikeFuels can be shared with your Withings account. You'll have to stick to the Nike+ app to see the rest of your Nike+ data.

Note that it can take up to 48 hours after the association for your data to be shared with your Nokia® account. You also need to have at least 5 days worth of Nike+ data before it can be shared with your Nokia® account.

Connecting to Nike+

To connect your Nokia® account to your Nike+ account, perform the following steps:

1. Open the Nokia Health Mate® app.
2. Tap **Profile**.

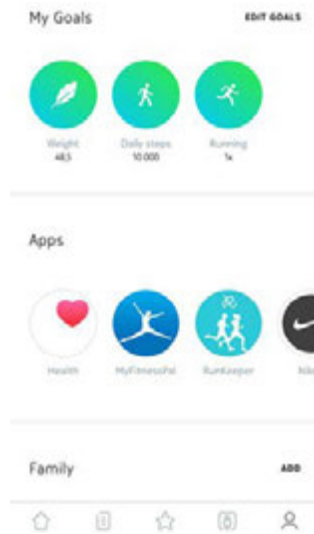

3. Tap **Nike+**.
4. Tap **Connect**.



5. Tap **Link with Nike+ FuelBand**.



6. Log in to your Nike+ account and follow the instructions.

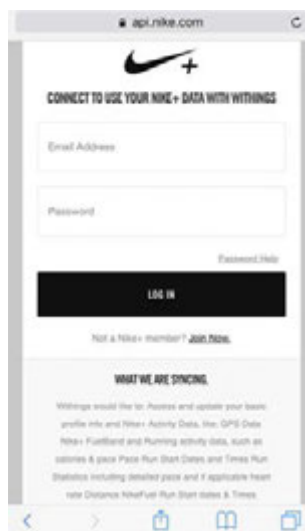

Note that it can take up to 48 hours after the association for your data to be shared with your Nokia® account.

You can unlink your Nike+ account and your Nokia® account anytime you want from your Profile.

Syncing Your Data

Data from your Nokia Body+ is automatically synced, without any action required on your part. Your weight data is synced with the Nokia Health Mate® app within a few minutes after you weigh in.

Note that if you sync your data in Bluetooth, it is necessary that a paired device is within range of the scale. The Nokia Health Mate® app also needs to be running on your device.

Dissociating Your Nokia Body+



All data that wasn't synced before dissociating your Nokia Body+ will be lost permanently.

Dissociating your Nokia Body+ allows you to remove it from your account.



Dissociating your Nokia Body+ will not remove any of the data that was synced from the Nokia Health Mate® app.

To dissociate your Nokia Body+, perform the following steps:

1. Open the Nokia Health Mate® app.
2. Go to **My devices**.
3. Tap **Body+**.

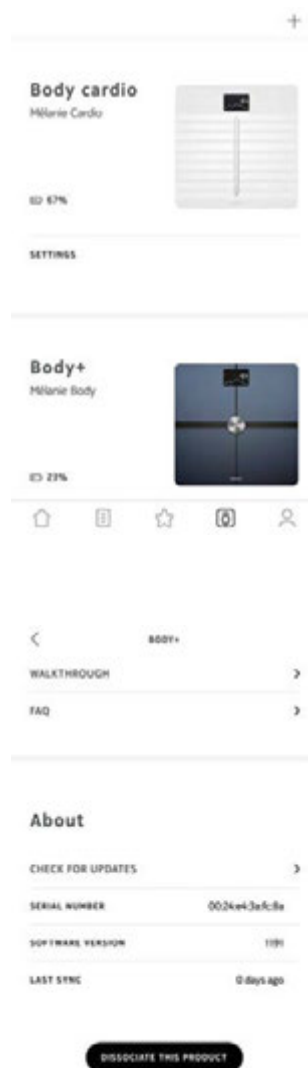

4. Tap **Dissociate this product**.

5. Tap **Remove from my account**.

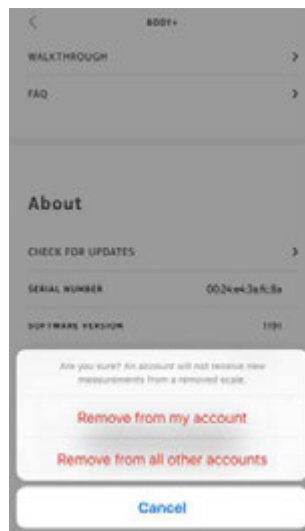

6. Perform a factory reset of your Nokia Body+. Refer to [“Performing a Factory Reset of Your Nokia Body+”](#) on page 51 for more information.

Performing a Factory Reset of Your Nokia Body+



All data that wasn't synced before factory resetting your Nokia Body+ will be lost permanently.

Factory resetting your Nokia Body+ allows you to delete the data stored on it. Factory resetting completes the dissociation process.



Factory resetting your Nokia Body+ will not remove any of the data from the Nokia Health Mate® app.

1. Go to the Bluetooth settings of your device and “forget” your Nokia Body+. from the list of Bluetooth devices.
2. Remove one of the batteries for ten seconds.
3. Put the battery back.
4. When “Hello” appears on the display of your scale, press and hold the button at the back of the scale until the factory reset gauge fills.
The scale's screen will display the word “Factory”, confirming the reset.

At this time, you can start the installation process for the Nokia Body+. Refer to [“Setting Up the Nokia Body+” on page 8](#) for more information.

Cleaning and Maintenance

Cleaning your Nokia Body+

You can clean your Nokia Body+ using a cloth dampened with water. If water is not enough to clean it, you can also use crystal vinegar.



The use of any detergents or cleaners may cause irreversible damage to the coating that protects the electrodes used to measure your body composition.

Changing the batteries

Your Nokia Body+ uses four standard AAA batteries and has an autonomy of 8 months. To check the battery level of your Nokia Body+, perform the following steps:

1. Open the Nokia Health Mate® app.
2. Go to **My devices**.

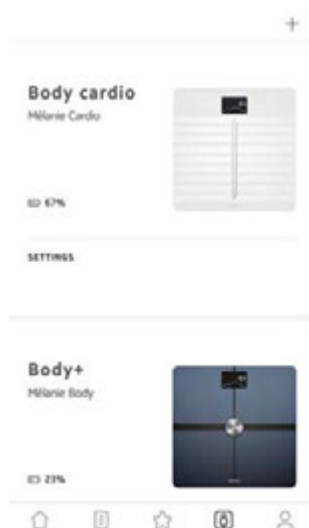

3. Check the battery level displayed on the left of your scale.

If the battery level is below 20% and you're having syncing issues, we advise that you change the batteries.

Installing the carpet feet

If you are using your Nokia Body+ on a carpet, we recommend that you use the carpet feet included with your scale. To do so, perform the following steps:

1. Remove the tab below each carpet foot.

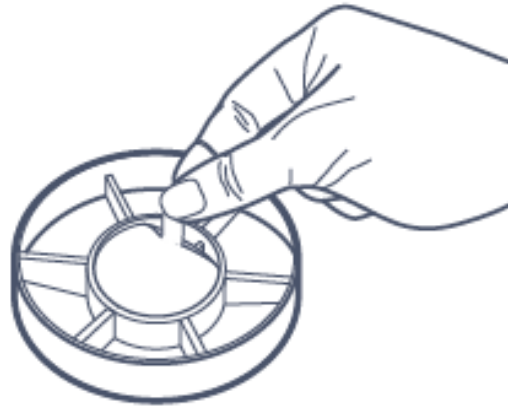

2. Stick each carpet foot on the Nokia Body+ feet.

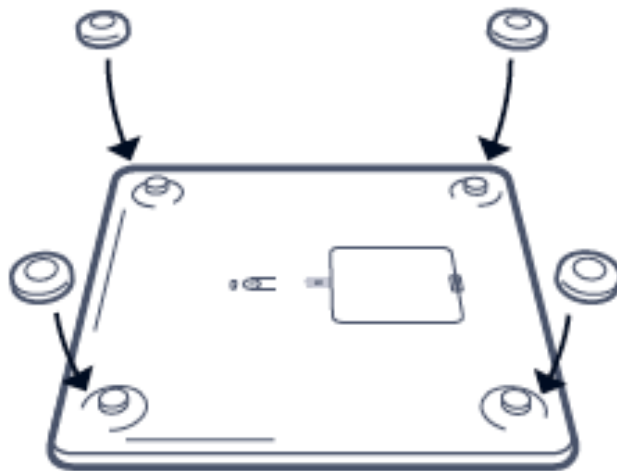

Updating your Nokia Body+

We regularly offer updates so that you can benefit from the latest features we add to our products. When new internal software is available, it is automatically installed without any prompt from the Nokia Health Mate® app if your scale is installed in Wi-Fi.

However, you can check if updates are available and force their installation whenever you want. To do so, perform the following steps:

1. Open Nokia Health Mate® app.
2. Go to **My devices**.

3. Tap **Body+**.

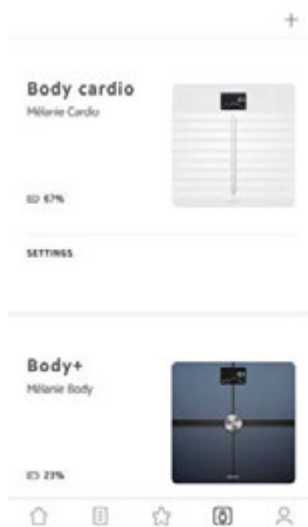

4. Tap **Check for updates**.



5. Press the button at the back of the scale and tap **Next**.

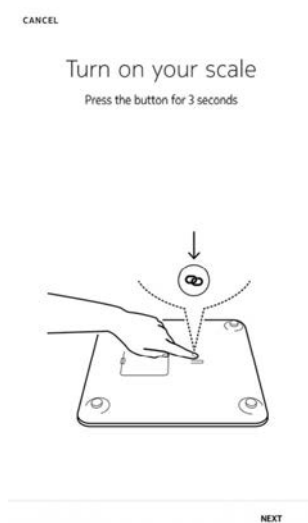

6. Tap **Upgrade**.

7. Tap **Close** when the upgrade is complete.

Note: You can check which firmware version your Nokia Body Cardio uses in **My devices > Nokia Body+**.

Weight

Your weight is measured thanks to four weight sensors placed below the surface of your Nokia Body+.

Body Composition

Your body composition (fat mass and water percentage, muscle mass, and bone mass) is measured by bioelectrical impedance analysis thanks to electrodes placed below the surface of your Nokia Body+. These electrodes send a small current that goes through your body, and then analyse the way your body reacts to measure these metrics.

Specifications

Nokia Body+

- Length: 325 mm (12.8")
- Width: 325 mm (12.8")
- Depth: 23 mm (0.90")
- Weight: 2.1 kg (4.6 lbs)
- Weight range: 5 kg - 180 kg (9 lbs - 396 lbs)
- Weight units: kg, lb, stlb
- Precision: 100 g (0.2 lbs)

Display

- 6.1 cm x 4.1 cm (2.4" x 1.6")
- 128 x 64 pixels
- Backlighting

Connectivity

- Wi-Fi 802.11 b/g/n (2,4 GHz only)
- Bluetooth / Bluetooth Low Energy (Bluetooth Smart Ready)

Sensors

- 4 weight sensors
- Position Control™ technology

Metrics

- Weight
- Fat mass (%) - standard and athlete mode
- Muscle mass (kg)
- Bone mass (kg)
- Water mass (%)

Batteries

- 8 months autonomy
- 4 AAA batteries

Features

- Automatic user recognition
- Weather forecast

Compatible Devices

- iPhone 4s (or higher)
- iPod Touch 4th Gen (or higher)
- iPad 2nd Gen (or higher)
- Android device running Android 2.3.3 (or higher)

Compatible OS

- iOS 8.0 (or higher)
- Android 2.3.3 (or higher)

User Guide Copyright

This User Guide is protected by Intellectual Property laws and copyright. Any reproduction, modification, representation, and/or publication without Nokia® prior approval is strictly prohibited. You may print this User Guide for your personal use exclusively. For any questions, please contact Nokia Health at: <http://nokia.ly/HealthSupport>.

Legal Notice



This product is not a medical device and should not be used to diagnose or treat any medical condition.

People wearing a pacemaker or any other internal medical device should disable the body composition measurement. Refer to “Disabling body composition measurements” on page 28 for more information.

	Identity data means the data which can directly identify you.
	Body metrics data means data which correspond to an accurate measurement of your physical features and your body activity.
	Activity data means data which correspond to a measurement of your physical/sports activities.
	Cookies - technical features mean data, not directly identifying you, which allows you to use our Products and Services and allow us improve your personal experience.

Personal Data

- Make sure you have read our privacy policy, which you can find on our [website](#).
- Make sure your Nokia® account password is secure enough to restrict access to your account. It should be at least eight-character long, have mixed case, and use a combination of alphanumeric and special characters.
- We recommend that you protect access to the Nokia Health Mate® app with an additional passcode and/or Touch ID. You can do so from the app by going to **Settings** in the app and activating **Touch ID and Passcode**.
- We recommend that you export your data on a regular basis to local storage on your home computer. You can do so from the Nokia Health Mate® [web interface](#) by clicking

your **Profile picture** > **Settings** > **User Preference** > **Download my data**.

Use and Storage

- Use the product at temperatures between 5°C and 35°C (41°F and 95°F) with a relative humidity between 30% and 80%.
- Product may be stored in a clean location between -10°C and 50°C (14°F and 122°F) when it is not in use, with a relative humidity between 10% and 90%.
- This product is not a toy. Do not allow children to play with it.
- This device is designed for indoor use only.
- Do not allow the device to come in contact with liquids.
- Do not use any detergents or cleaners to clean the scale. They may cause irreversible damage to the coating that protects the electrodes used to measure your body composition.

Location

- Do not use your Nokia Body+ in a place that is too humid as it can affect the batteries.
- Make sure you use the carpet feet if you place your Nokia Body+ on a carpet.

Service and Maintenance

- Do not attempt to repair or modify your Nokia Body+ yourself. Service and maintenance not described in this User Guide should be performed by professional technicians.
- If you have any issues, feel free to contact customer service at: <http://nokia.ly/HealthSupport>.

Document Release Overview

Release date		Modifications
May 2016	v1.0	First release
December 2016	v2.0	Update of: “Legal Notice” on page 59 Update of: “Disabling body composition and heart rate measurements” on page 25
August 2017	v3.0	Nokia graphic chart



The screenshots in this manual are used for explanatory purposes. Your actual screens may differ from the screenshots in this manual.

Warranty

Nokia® One (1) Year Limited Warranty - Nokia Body+

Nokia® warrants the Nokia® branded hardware product (“Nokia Body+”) against defects in materials and workmanship when used normally in accordance with Nokia®’ published guidelines for a period of ONE (1) YEAR from the date of original retail purchase by the end-user purchaser (“Warranty Period”). Nokia®’s published guidelines include but are not limited to information contained in technical specifications, safety instructions, or quick start guide. Withings does not warrant that the operation of the Nokia Body+ will be uninterrupted or error-free. Nokia® is not responsible for damage arising from failure to follow instructions relating to the Nokia Body+’s use.

The warranty does not extend to:

- Any damage to the device resulting from abnormal or abusive use, negligence or lack of care, or accidental damage (such as dents).
- Indirect damages of any kind.

Regulatory Statements

FCC ID: XNAWBS05

This device complies with Part 15 of the FCC Rules.

Operation is subject to the following two conditions: (1) This device may not cause harmful interference, and (2) This device must accept any interference received, including interference that may cause undesired operation.

This device complies with the R&TTE Directive. A copy of the EU Declaration of Conformity is available online at <http://www.nokia.com/compliance>