

Miele

HONEYCOMB CARE

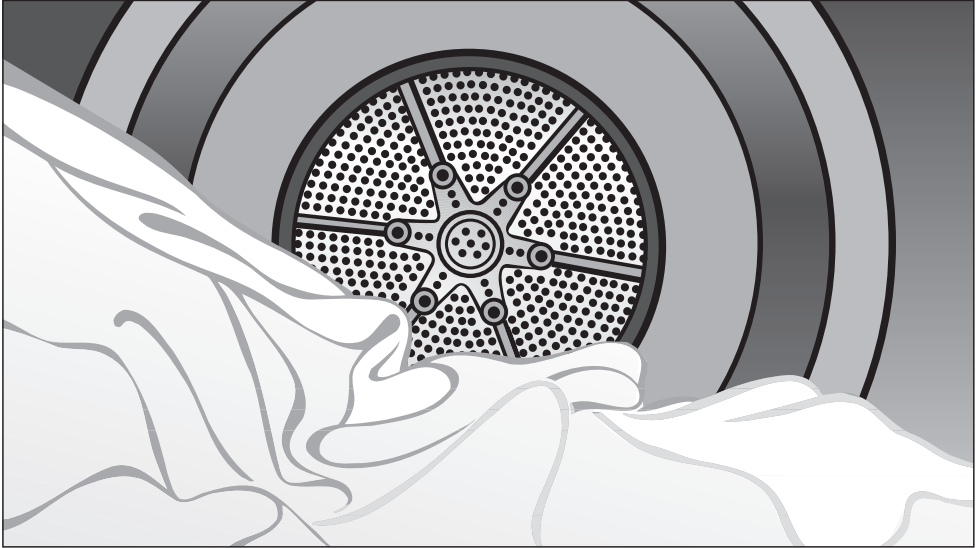
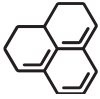

Operating instructions for condenser tumble dryer T 7744 C

It is **essential** to read these operating instructions before installing or using the machine to avoid the risk of accidents or damage to the machine.

en - AU, NZ

M.-Nr. 06 605 540

Caring for the environment

Disposal of the packing material

The transport and protective packing has been selected from materials which are environmentally friendly for disposal and can normally be recycled.

Ensure that any plastic wrappings, bags, etc. are disposed of safely and kept out of the reach of babies and young children. Danger of suffocation.

Rather than just throwing these materials away, please ensure they are offered for recycling.

Disposal of your old appliance or machine

Electrical and electronic appliances / machines often contain materials which, if handled or disposed of incorrectly, could be potentially hazardous to human health and to the environment. They are, however, essential for the correct functioning of your appliance or machine. Therefore, please do not dispose of your old machine or appliance with your household waste.

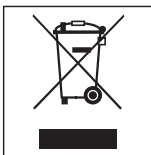

Please dispose of it at your local community waste collection / recycling centre and ensure that it presents no danger to children while being stored for disposal.

It should be unplugged or disconnected from the mains electricity supply by a competent person.

The plug must be rendered useless and the cable cut off directly behind the appliance or the machine to prevent misuse.

Energy saving tips

To avoid unnecessarily long drying times and high consumption of energy:

- Make sure that your laundry is thoroughly spun before drying.

The higher the spin, the greater the savings that can be made in energy and time during drying.

- Load according to the optimum amount of laundry recommended for the programme being used (see Programme chart).

Underloading is uneconomical. Overloading gives a poorer quality of drying and may cause unnecessary creasing.

- Make sure the room in which the dryer is located is well ventilated.
- Make sure the fluff filters are clean before using the dryer.
- Check the condenser unit from time to time and clean it when necessary.

Caring for the environment	2
Warning and Safety instructions	5
Operating the tumble dryer	10
Control panel	10
Notes on laundry care	12
Care symbols	12
Tips on drying	12
How to dry correctly	13
Brief instructions	13
Additional options/Delay start	16
Low temperature	16
Buzzer	16
Delay start	16
Programme chart	17
Changing the programme sequence	20
Once a programme has started	20
- changing the programme	20
- cancelling the programme and then selecting a different programme	20
- cancelling the programme and then removing the laundry	20
Adding or removing laundry after a programme has started	20
Time remaining	20
Electronic system lock	21
Cleaning and care	22
Emptying the condensed water container	22
Cleaning the fluff filters	23
Cleaning them whilst dry	23
Cleaning them with water	24
Cleaning the tumble dryer	24
Cleaning the condenser unit	25
Removing the condenser unit	25
Checking the condenser unit	26
Cleaning the condenser unit	26
Replacing the condenser unit	27

Contents

Problem solving guide	28
Check and fault messages	28
Other problems	30
Changing the lamp	33
After Sales service	34
Future updates (PC)	34
Optional accessories	34
Installation and connection	35
Front view	35
Rear view	36
Installation site	36
Transporting the machine to its installation site	36
Washer-dryer stack	36
Levelling the machine	37
Room ventilation	37
Before moving the machine again (e.g. when moving house)	37
External condensed water outlet	38
Arranging the drain hose	38
External drainage via a sink or gully	39
Installation conditions requiring a non-return valve	39
Electrical connection	41
Consumption data	42
Technical data	43
Programmable functions	45
Extending the range of the drying levels	45
Altering the volume of the buzzer	46
Memory function	47
Extending the cooling down time	48
Clean out airways indicator	49
Keypad tone	50
Adjusting the dryer's electronics for very soft water	51

Warning and Safety instructions

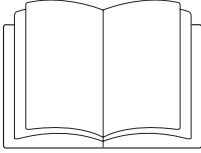

► It is **essential** to read these instructions.

This tumble dryer conforms to current safety requirements. Inappropriate use can, however, lead to personal injury and damage to property.

To avoid the risk of accidents and damage to the tumble dryer, please read these instructions carefully before using it for the first time. They contain important information on its safety, installation, use and maintenance.

Keep these instructions in a safe place and ensure that new users are familiar with the content. Pass them on to any future owner.

Correct application

► This tumble dryer is not designed for commercial use. It is intended for use in domestic households and in similar working and residential environments such as:

- Shops
- Offices and showrooms

and by residents in establishments such as

- Hostels and guest houses

► It must only be used as a domestic appliance to dry items which have been washed in a water solution and which are marked on the manufacturer's care label as being suitable for tumble drying. "Dry cleaning kits" for freshening up garments in a tumble dryer are increasingly available on the market. If using, do so at your own risk, and follow the instructions provided on the packaging.

Any other usage is not supported by the manufacturer and could be dangerous. Miele cannot be held liable for damage resulting from incorrect or improper use or operation of the tumble dryer..

► This appliance is not intended for use by persons (including children) with reduced physical, sensory or mental capabilities, or lack of experience or knowledge, unless they are supervised whilst using it or have been shown how to use it correctly by a person responsible for their safety.

Safety with children

► Keep children away from the tumble dryer at all times. It is not a toy! To avoid the risk of injury do not allow them to play on or near it or to play with its controls. Supervise children whilst you are using it.

► Older children may only use it if its operation has been clearly explained to them, and they are able to use it safely, recognising the dangers of incorrect use.

Warning and Safety instructions

Technical safety

▶ Before setting up the tumble dryer, check it for any externally visible damage.

Do not install or use a damaged tumble dryer.

▶ Before connecting the tumble dryer, ensure that the connection data on the data plate (voltage and connected load) match the mains electricity supply. If in any doubt, consult a qualified electrician.

▶ The electrical safety of this tumble dryer can only be guaranteed when continuity is complete between it and an effective earthing system which complies with current local and national safety regulations. It is most important that this basic safety requirement is present and regularly tested, and where there is any doubt the household wiring system should be inspected by a qualified electrician. Miele cannot be held liable for the consequences of an inadequate earthing system (e.g. electric shock).

▶ Do not connect the tumble dryer to the mains electricity supply by an extension lead. Extension leads do not guarantee the required safety of the tumble dryer (e.g. danger of overheating).

▶ Unauthorised repairs could result in unforeseen dangers for the user, for which Miele cannot accept liability. Repairs should only be undertaken by a Miele approved service technician. Ensure current is not supplied to the tumble dryer until after maintenance or repair work has been carried out.

▶ Faulty components must only be replaced by genuine Miele original spare parts. Only when these parts are fitted can the safety standards of the tumble dryer be guaranteed.

▶ If the connection cable is faulty it must only be replaced by a Miele approved service technician to protect the user from danger.

▶ In the event of a fault or for cleaning purposes, the tumble dryer is only completely isolated from the electricity supply when:

- it is switched off at the wall socket and the plug is withdrawn, or
- it is switched off at the mains, or
- the mains fuse is disconnected, or the screw-out fuse is removed (in countries where this is applicable).

▶ This tumble dryer may only be used in mobile installations such as ships if a risk assessment of the installation has been carried out by a suitably qualified engineer.

▶ In areas which may be subject to infestation by cockroaches or other vermin, pay particular attention to keeping the tumble dryer and its surroundings in a clean condition at all times. Any damage which may be caused by cockroaches or other vermin will not be covered by the guarantee.

▶ Do not make any alterations to the tumble dryer, unless authorised to do so by Miele.

Warning and Safety instructions

Correct use



READ THE INSTRUCTIONS

⚠ To avoid the possible danger of fire please read these warnings carefully.

⚠ A clogged filter is a fire hazard! The lint filter must be cleaned after every program.

- ▶ Remove all objects from pockets such as lighters and matches.
- ▶ To prevent the risk of fire, the following textiles must not be dried in this tumble dryer:
 - Items which have not been washed.
 - Items, such as workwear, which have not been thoroughly cleaned and which are still soiled with grease, oil or other desposits (such as cosmetics, lotions etc).
If items have not been thoroughly cleaned there is a danger that these might ignite when heated, even after they have been removed from the dryer at the end of the programme.

- Items that have been soiled with substances such as cooking oil, acetone, petrol, kerosene, spot removers, turpentine, waxes, wax removers and other chemicals (e.g. mops and floor cloths) should be washed in hot water with extra amount of detergent before being dried in the tumble dryer.
- Items which have been splashed with hair lacquer, hair spray, nail polish remover or similar substances.

When washing such heavily soiled items ensure that you use sufficient detergent and select a high temperature. If in doubt, wash the items several times.

- ▶ Oil-affected items can ignite spontaneously, especially when exposed to heat sources such as in a tumble dryer.

The items become warm, causing an oxidation reaction in the oil. Oxidation creates heat.

If the heat cannot escape, the items can become hot enough to catch fire. Piling, stacking or storing oil-affected items can prevent heat from escaping and so create a fire hazard.

If it is unavoidable that fabrics that contain vegetable or cooking oil or have been contaminated by hair care products be placed in a tumble dryer they should first be washed in hot water with extra detergent - this will reduce, but not eliminate, the hazard.

Warning and Safety instructions

▶ To prevent the risk of fire, the following textiles or products must not be dried in this tumble dryer:

- Items which have been dry-cleaned (for example with a chemical treatment).
- Fabrics which contain a large proportion of rubber, foam rubber or rubber-like materials. For example, products made from latex foam rubber, shower caps, waterproof textiles, rubberised articles and items of clothing and pillows with foam rubber filling.
- Fabrics which contain padding or fillings (e.g. pillows, jackets). If these were damaged the filling could get out with the risk of igniting in the dryer.

▶ In many programmes, the heating phase is followed by a cooling down phase to ensure that the items are not too hot to handle when you remove them (this also avoids the danger of the laundry self-igniting). The programme is not finished until the cooling down phase is complete.

Ensure that you always wait until the end of the programme before removing the laundry.

▶ **Warning:** Do not switch the tumble dryer off before the end of the drying programme. If this was done and the laundry was then removed immediately, it could give off a great amount of heat.

▶ Fabric conditioner and similar products must be used according to the instructions on the manufacturer's packaging.

Warning and Safety instructions

▶ The dryer must not be used without the fluff filters in place or if the fluff filters are damaged in any way.

▶ The fluff filters must be cleaned regularly.

▶ The dryer must not be used without the condenser unit in place.

▶ The fluff filters must be thoroughly dried after cleaning. Damp or wet filters could cause operational faults.

▶ Do not install the tumble dryer in a room where there is a risk of frost occurring. At temperatures around freezing point the tumble dryer may not be able to operate properly. There is a risk of damage if the condensed water is allowed to freeze in the pump, hoses and / or condensed water container.

The ambient room temperature should be between +2°C and +35°C.

▶ If the water is drained externally through the drain hose instead of being collected in the condensed water container, make sure the drain hose is securely attached if you hang it in a sink or basin to avoid the hose slipping and the water causing damage.

▶ Condensed water is not drinking water.

It can cause health problems in both people and animals.

▶ Always keep the area around the tumble dryer free of dust and fluff. Dust drawn into the tumble dryer can cause blockages in the condenser unit over time.

▶ Do not let anyone sit or lean on the door, as this can cause the tumble dryer to tip up.

▶ Always close the door after use. This way you will avoid the danger of:

- Children climbing onto or into the dryer or hiding things in it.
- Pets or other small animals climbing into it.

▶ The tumble dryer must not be hosed down.

Accessories

▶ Only use genuine Miele spare parts and accessories with this appliance. If non-Miele parts are used, guarantee, performance and product liability claims may be invalidated.

Miele cannot be held liable for damage caused by non-compliance with these Warning and Safety instructions.

Operating the tumble dryer

Control panel

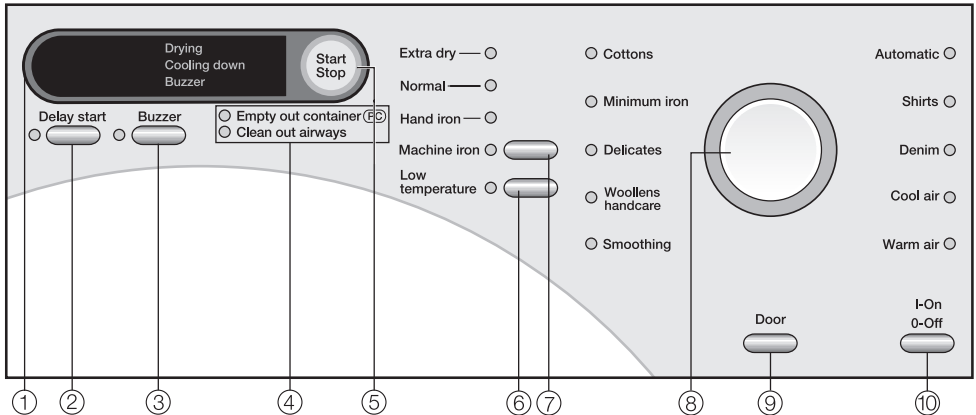

① Display

② Delay start button

This button is used for:

- Selecting the duration of the *Warm air* and *Cool air* programmes
- Delaying the start of a programme

③ Buzzer button

An audible tone sounds at the end of the programme.

④ Check lights

These indicator lights have various functions. See "Problem solving guide" / "After sales service" for details.

⑤ Start/Stop button

For starting the programme selected and cancelling a programme once it has started.

The button flashes while a programme is being selected and then is on constantly when the programme has started.

⑥ Low temperature button

Delicate fabrics are dried at a lower temperature.

⑦ Drying level button with indicator lights

⑧ Programme selector with indicator lights

⑨ Door button

Pressing this button will open the door even when the machine is switched off at the mains.

⑩ I-On/0-Off button

For switching the dryer on and off.

Display

The following are selected via the display:

- Delay start
- Duration of the Cool air and Warm air programmes
- Programmable functions

The display also shows:

- Programme duration
- Programme stage
 - Drying*
 - Cooling down*
 - Finish*
- Check and fault messages

Programme duration / Estimated time remaining

When a programme is selected, the estimated duration (time remaining) will appear in the display. Please be aware that it is only an estimate!

The following factors all affect the estimated time remaining: residual moisture content after spinning; type of fabric; size of load; room temperature; fluctuations in power supply.

The electronics continually assess conditions in the dryer and adjust the estimated time remaining for a more accurate reading. Because of this, the time displayed can alter during the course of a programme.

In the same way, the *Woollens handcare*, *Silks handcare* and *Smoothing* programmes can finish earlier than expected if a certain temperature is reached. This can happen with particularly fine fabrics, very small loads or if items were partly dry beforehand.

Delay start

The delay start time selected will appear in the display.

After the Start/Stop button has been pressed, the delay start time will start counting down.

Once the delay start time has elapsed, the programme will begin and the estimated programme duration will appear in the display.





Programmable functions

The programmable functions can be used to tailor drying programmes to suit your individual requirements. In programming mode, the display will show the function selected.

Notes on laundry care

Care symbols

Before drying check the drying symbol on the care label. If there are no symbols, dry at your own risk!

-  Dry at normal temperature
 -  Dry at a low temperature
 -  Do not tumble dry
- Cottons, linens and minimum iron items should be dried using the appropriate programme for the degree of dryness required.
 - For delicates and fabrics with the following care label  select the *Low temperature* extra option.

Tips on drying

Always observe the maximum recommended loads given in the "Programme chart". Never overload the drum. Overloading can cause unnecessary wear and tear to the laundry, give a disappointing drying result and cause more creasing.

Do not put soaking wet items into the tumble dryer. Spin them thoroughly after washing using the appropriate spin speed.

- Woollens and wool blends tend to become matted and shrink if dried in a tumble dryer. They can, however, be partially dried using the *Woollens hand care* programme.

- Down-filled garments have linings which have a tendency to shrink, depending on the quality of the item. They can be partially dried using the *Smoothing* programme.
- Pure linen should only be machine dried if specified as suitable by the manufacturer on the care label, as the surface of the fabric may otherwise become rough. They can be partially dried using the *Smoothing* programme.
- Loopknit garments (e.g. T-shirts and underwear) tend to shrink depending on their quality. Do not over-dry these textiles. When purchasing these garments it is advisable to take their shrinkage properties into account.
- Minimum iron fabrics and 100% cotton shirts or blouses tend to crease more the greater the load. This is especially true of very fine weaves, such as shirts or blouses. Reduce the load or use the *Shirts* programme.
- Starched laundry can be dried in the tumble dryer. To achieve the usual finish, double the amount of starch should be used.
- New dark coloured garments should be washed and dried separately from light coloured garments to avoid the danger of colours running and discolouring other garments or even plastic components in the machine. Dark coloured fibres can also settle on light coloured garments and vice versa.

Brief instructions

The headings numbered (1, 2, 3 ...) show the operating sequence and can be used as a brief guide to using your dryer.

1 Sort the laundry

To ensure an even drying result separate out the washed laundry and sort it according to:

- ... the drying level required
- ... the type of fibre or weave
- ... size
- ... the moisture content after spinning.

 Make sure that objects e.g. detergent dispensing balls have been removed from the laundry. They could melt, and cause damage to the dryer or the laundry.

- Remove all objects from pockets such as lighters and matches.
- Check seams and stitching to ensure that padding and linings are intact.
- Fasten duvet covers and pillow cases to prevent small items from being trapped inside them.
- Fasten zips, hooks and eyes etc.
- Tie fabric belts and apron strings.
- Sew in or remove underwiring from bras.

2 Turn on the tumble dryer

- Switch the dryer on by pressing the *I-On/0-Off* button in.

The tumble dryer may be switched on after loading, saving energy as the light will not come on.

3 Load the tumble dryer

- Press the *door* button to open the door.
- Load the laundry loosely into the drum.

Do not overload the drum. See the "Programme chart" for recommended loads for each programme. Overloading can cause unnecessary wear and tear to the laundry and give a disappointing drying result.

- Before closing the door make sure the fluff filter is correctly positioned in the door.

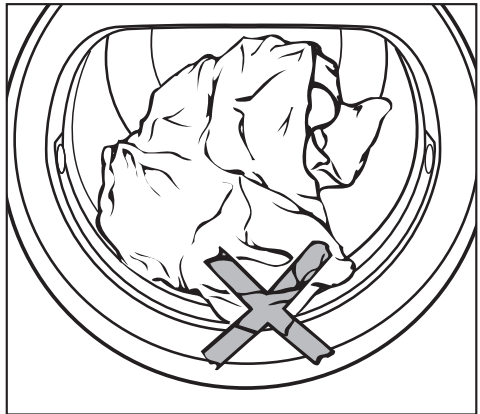

Check the laundry is right inside the drum so that it cannot get trapped or damaged when the door is shut.

- Shut the door either with a gentle swing, or lean against it and push it shut.

How to dry correctly

4 Select a programme

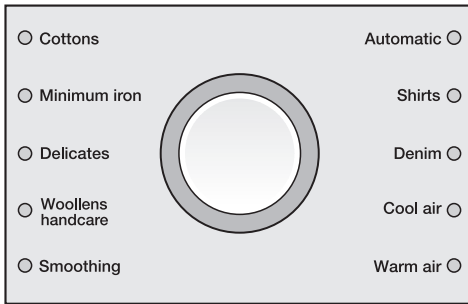

- Select the programme you want.

The *Cottons Normal Plus* program is recommended for a normal load and is the program used in energy consumption tests in accordance with AS/NZS 2442.1 (refer to www.energyrating.gov.au for consumption data)

The indicator light for the programme selected will light up. A drying level or additional option(s) indicator light may also light up, or a time may appear in the display (Memory function).

Programmes with drying levels:
Cottons, Minimum iron, Delicates, Automatic, Shirts, Denim

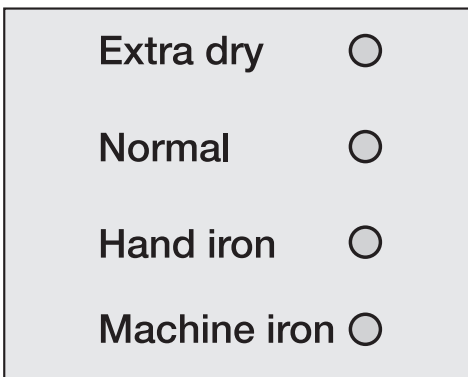

- Press the Drying level button repeatedly until the indicator light for the drying level you want lights up.

Any of the drying levels can be selected for the *Cottons* programme. A more limited range is available when using other programmes.

Important: Please note that the programme duration shown in the display will vary according to the programme selected (see "Programme duration / Estimated time remaining").

You cannot alter the drying level of the *Woollens handcare* and *Smoothing* programmes.

Cool air and Warm air programmes

The indicator light for the *Delay start* button will flash when the *Cool air* or *Warm air* programme is selected.

- Press the *Delay start* button repeatedly until the required duration shows in the display.

You can select a duration of 20 minutes up to 2 hours in 10 minute steps.

5 Select any additional options

- The *Low temperature, Buzzer, and Delay start* additional options are selected by pressing the appropriate button (see "Additional options" for more details).

N.B.: It is not possible to select *Delay start* when using the *Warm air* or *Cool air* programme.

6 Start the programme

The *Start/Stop* button will flash when a programme is being selected. The flashing indicates that a programme can be started.

- Press the *Start/Stop* button.

The *Start/Stop* button will now light up constantly.

Drying will appear in the display and the time remaining will start counting down.

Before the end of a programme

There is a cooling down phase at the end of the drying sequence (*Cooling down* will light up in the display). The programme will not finish until the cooling down phase has been completed.

There is no cooling down phase at the end of the following programmes: *Woollens handcare*, *Smoothing*.

7 Remove the laundry when the programme has finished

0 and *Finish* will appear in the display to indicate that the programme has finished. The buzzer (if selected) will sound at intervals.

The drum will continue to rotate at intervals to prevent laundry creasing, if you do not wish to remove it immediately (anti-crease). The anti-crease phase lasts for an hour. There is no anti-crease phase at the end of the *Woollens handcare* programme.

- Press the *Door* button.
- Open the door.
- Remove the laundry.

Check that all items have been removed from the drum. If items are left in the dryer, they could be damaged by overdrying when the dryer is next used.

If the dryer is switched on at the mains and the door is opened, the drum lighting will come on. It will go out a few minutes later to save energy.

- Switch the dryer off by pressing the *I-On/O-Off* button.
- Clean the fluff filters.
- Close the door.
- Empty the condensed water container (unless the dryer has been connected for external drainage).
- The condenser unit should be checked and cleaned on a regular basis.

Additional options/Delay start

Low temperature

For all delicate or minimum iron fabrics with the  symbol on the care label (e.g. acrylic garments).

- The programme duration is longer.
- On some programmes *Low temperature* is a standard part of the programme and so cannot be deselected.

Buzzer

A buzzer sounds (at intervals for a maximum of 1 hr) to let you know the programme has finished.

The buzzer will still sound if there is a fault, even if it has been switched off.

Delay start

The start of a programme can be delayed by 30 minutes up to 24 hours.

After selecting a programme:

- Press the *Delay start* button repeatedly until the required delay period shows in the display.
- The *Delay start* indicator light will flash.
- Times of:
 - up to **10h** are selected in 30 minute steps
 - more than **10h** in 1 hour steps
- If you keep the *Delay start* button pressed in, the time will continue to increase up to **24h**.

To begin delay start

- Press the *Start/Stop* button.
- The *Delay start* indicator light will light up constantly.

The delay start time counts down towards the start of the programme as follows:

- more than **10h** by the hour
- less than **10h** in minutes

The drum will turn briefly every hour to help prevent creasing.

While the delay start time is counting down, you can still add laundry to the drum:

- Switch the dryer off.
- Open the door and add the laundry.
- Close the door and switch the dryer back on again.



To cancel/alter delay start

- Press the *Start/Stop* button.

This cancels delay start.



- To alter the delay start time, press the *Delay start* button repeatedly until the required delay period shows in the display.
- Press the *Start/Stop* button.
- The altered delay start time will start counting down from the beginning again.

Programme chart

Cottons		Max. load: 6 kg*
Extra dry, Normal		
Fabric type	Single and multi-layered cotton fabrics such as towelling, jerseywear, T-shirts, underwear.	
Notes	<ul style="list-style-type: none"> – Select <i>Extra dry</i> for multi-layered and very thick fabrics. – Do not use <i>Extra dry</i> for jersey fabrics (e.g. T-shirts, underwear), as they have a tendency to shrink. 	
Low temperature	Also select the Low temperature option for delicate fabrics with the  symbol on the care label.	
Hand iron, Machine iron		
Fabric type	Cottons or linen fabrics, e.g.: table linen, bed linen, starched laundry.	
Note	– To prevent laundry from drying out it should be rolled up until you are ready for ironing.	
Low temperature	Also select the Low temperature option for delicate fabrics with the  symbol on the care label.	
Minimum iron		Max. load: 3 kg*
Extra dry, Normal, Hand iron		
Fabric type	Minimum iron items made of cotton, synthetic or blended fabrics, e.g.: shirts, blouses, skirts and table cloths.	
Notes	<ul style="list-style-type: none"> – Select <i>Hand iron</i> for delicate fabrics and to reduce creasing even more, reduce the load to 1.5 kg*. – In the Minimum iron programme with the <i>Hand iron</i> drying level, items are dried with very little creasing, depending on fabric type and amount of laundry. 	
Low temperature	Also select the Low temperature option for delicate fabrics with the  symbol on the care label.	
Delicates		Max. load: 2 kg*
Normal, Hand iron		
Fabric type	Delicate items made of synthetic fibres, easy care cotton or blended fabrics, e.g. shirts, blouses and evening wear with sequins and beading.	
Low temperature	Low temperature cannot be deselected.	

* Weight of dry laundry

Programme chart

Woollens handcare		Max. load: 2 kg*
Fabric type	Woollen fabrics	
Notes	<ul style="list-style-type: none"> – This programme only fluffs up woollen garments. They are not dried completely by this programme. – Remove garments as soon as the programme has finished and leave to finish drying at room temperature. 	
Low temperature	Low temperature cannot be deselected.	
Smoothing		Max. load: 3 kg*
Fabric type	<ul style="list-style-type: none"> – Cotton and linen fabrics. – Minimum iron items made of mixed fibres, cottons or synthetics, e.g.: trousers, jackets, shirts. 	
Notes	<ul style="list-style-type: none"> – Smooths out creasing caused during the spin cycle in the washing machine. – Fabrics are not completely dried in this programme. Remove garments as soon as the programme has finished and leave to finish drying at room temperature. 	
Low temperature	Low temperature cannot be deselected.	
Automatic		Max. load: 3.5 kg*
Normal, Hand iron		
Fabric type	Mixed loads of garments suitable for the <i>Cottons</i> and <i>Minimum iron</i> programmes. Sort according to colour.	
Shirts		Max. load: 2 kg*
Normal, Hand iron		
Garments	Shirts and blouses.	
Low temperature	Also select the Low temperature option for delicate fabrics with the  symbol on the care label.	
Denim		Max. load: 3 kg*
Normal, Hand iron		
Fabric type	Denim garments, e.g. jeans, jackets, skirts, shirts.	
Low temperature	Also select the Low temperature option for delicate fabrics with the  symbol on the care label.	

* Weight of dry laundry

Programme chart

Cool air		Max. load: 6 kg*
Fabric type	– Any item which only needs airing.	
Warm air		Max. load: 6 kg*
Fabric type	<ul style="list-style-type: none"> – "Voluminous" and multi-layered fabrics whose layers have different drying characteristics, e.g. jackets, pillows. – For drying individual items, e.g. bath towels, bathing costumes, tea-towels and small loads. 	
Note	Do not select the longest drying time to start with. Check the items as you are drying them to find the optimum time.	
Tip	You can use the <i>Warm air</i> programme to help remove odours from cotton clothing which has been worn but is still clean (select a duration of between 1/2 and 1 hour). Items must be suitable for drying in a tumble dryer. Dampen the garments a little beforehand or add a fabric conditioner sheet. The Warm air programme will not be as effective at removing odours from any parts of the garments which are made of synthetic fibres.	
Low temperature	Also select the Low temperature option for delicate fabrics with the  symbol on the care label.	

* Weight of dry laundry

Changing the programme sequence

Once a programme has started

- changing the programme

You cannot change to another programme once a programme has started (this prevents unintentional alterations).

You will need to cancel the current programme before you can select a new one.

- cancelling the programme and then selecting a different programme

- Press the *Start/Stop* button.

The items will be cooled down, depending on the temperature reached and how long they have been dried for.

If you press the *Start/Stop* button again during the cooling down phase, *Finish* will light up in the display.

- Switch the dryer off.
- Switch the dryer on.
- Select another programme and start it.

- cancelling the programme and then removing the laundry

- Proceed as described in "Adding or removing laundry after a programme has started" below.
- Switch the dryer off after closing the door.

Adding or removing laundry after a programme has started

- Press the *Door* button.
- Open the door.



Danger of burning:

Do not touch the back of the drum when adding or removing items. The drum and the items can get very hot.

- Add or remove items as required.
- Close the door.
- Press the *Start/Stop* button.

Time remaining

The time left shown in the display may now vary from the actual drying time.

The system lock prevents your machine being used without your knowledge.

It can be activated if wished.

The dryer's electronics are then locked. The dryer can still be switched on but a programme cannot be started.

- If an attempt is made to start a programme, the indicator light for the *Low temperature* button will come on and a key symbol  will appear in the display.

The door is not locked and can be opened at any time.

To activate the lock

Before you begin, first ensure that:

- The tumble dryer is switched off.
- The door is closed.

➊ Press the *Low temperature* button and keep it pressed in whilst carrying out steps ➋ to ➍.

➋ Press the *I-On/O-Off* button in.

The *Automatic* indicator light will come on.

➌ Slowly turn the programme selector three positions stage by stage in a clockwise direction. Each of the three programme indicator lights must come on one after the other.

➍ Now slowly turn the programme selector six positions stage by stage in an anti-clockwise direction. Each of the six programme indicator lights must come on one after the other.

The indicator light for the *Low temperature* button will flash and a key symbol  will appear in the display.

➎ Release the *Low temperature* button.

The electronics have now been locked.

- Switch the dryer off.

To deactivate the lock

Before you begin, first ensure that:

- The tumble dryer is switched off.
- The door is closed.

■ The procedure is the same as for activating the lock. Carry out steps ➊ to ➍ as described previously.

At step ➍ the indicator light for the *Low temperature* button will stop flashing and the key symbol  will go out.

The electronics are no longer locked.

Cleaning and care

Emptying the condensed water container

The condensed water will be collected in the condensed water container unless the appliance has been fitted with a drain hose (see "Installation").

Empty the condensed water container after every drying programme.

The *Empty out container* indicator light will come on if the maximum level of the condensed water container is reached.

The indicator light will go out when the door is opened and closed again.

 Close the door fully. Otherwise the door and the front panel of the condensed water container could suffer damage when pulling the container out.

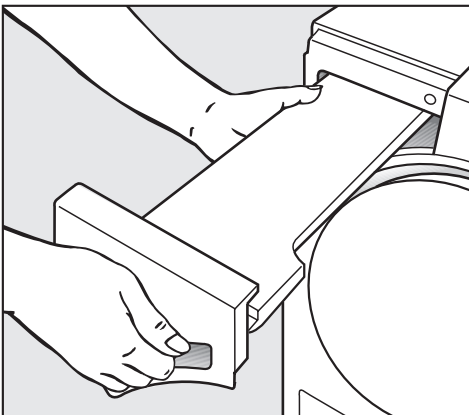

- Pull out the container.
- Hold it at the front and towards the back and keep it in a horizontal position when carrying it.

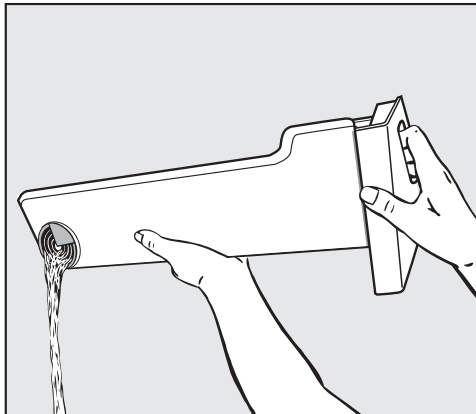

- Empty the container.
- Replace the container in the dryer.

 Condensed water should not be consumed. It could lead to health problems for people and animals.

Condensed water can be put to household use (e.g. in a steam iron or humidifier). To ensure that any residual particles of fluff in the condensed water are removed before use, pass it through a fine sieve or paper filter first.

Cleaning the fluff filters

The fluff which is created by the drying process is collected by the fluff filters in the door and the door opening. Clean the filters after **each** drying programme*.

Cleaning them whilst dry

Tip: You can also use a vacuum cleaner to remove the fluff.

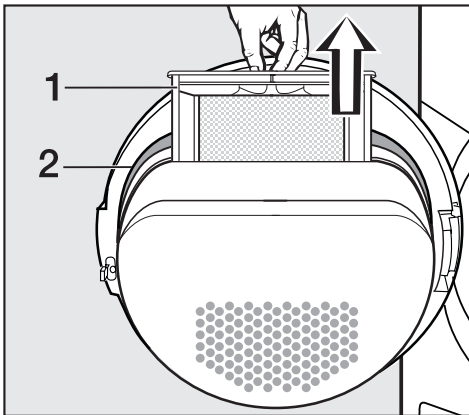

- Open the door and pull the fluff filter (1) out of the door as illustrated.

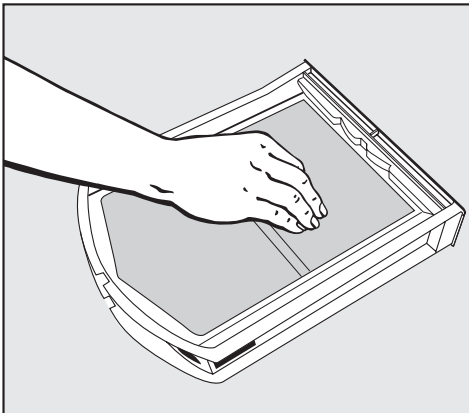

- Use your fingers to remove the fluff from the surface of the filter.

- Remove any fluff from the hollow part of the door opening. You could also use a cleaning brush which is available as an optional extra from your Miele dealer or the Miele Spare Parts Department, or use a vacuum cleaner.
- Also clean the door seal (2) with a damp cloth.
- Once clean, push the filter back into the door holder until it clicks into position. Ensure it is facing the correct way.

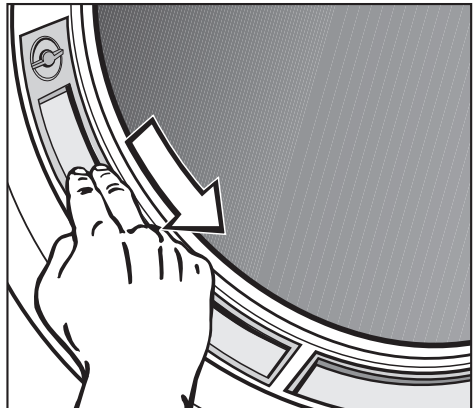

- Use your fingers or a vacuum cleaner to remove the fluff from the two fluff filters in the door opening.
- Close the door.

* Always check the fluff filters if the *Clean out airways* indicator light comes on.

 A clogged filter is a fire hazard! The lint filter must be cleaned after every program.

Cleaning and care

Cleaning them with water

If there is a great deal of compacted fluff on any of the filters, they can be removed and cleaned under hot running water.

- Open the door and pull the fluff filter out of the door as described previously.

The two filters in the door opening can also be removed if you need to clean them with water.

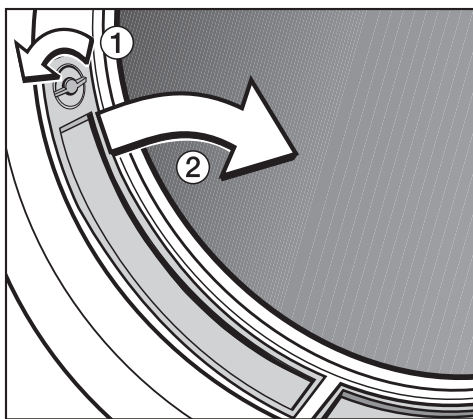

- Turn dial ① and pull the filter by the dial out of the door opening as shown ②. Do the same on the other side.
- Rinse all the filters under hot, running water.
- Then shake the filters until no more water droplets are visible.
- Dry the filters thoroughly with care.
- Clean the area underneath these filters, e.g. with a vacuum cleaner.

 Do not replace them if they are damp or wet. Damp or wet filters could cause operational faults.

- Push the large filter back into the door holder until it clicks into position. Ensure it is facing the correct way.
- Replace the filters in the door opening by first inserting them at the bottom and then pressing them into place at the top.
- Lock both dials.

Cleaning the tumble dryer

Disconnect the machine from the mains electricity supply.

- Clean the housing and control panel with a slightly damp cloth and a mild detergent or soapy water.
- The drum and other stainless steel parts can be cleaned with a suitable proprietary stainless steel cleaner following the manufacturer's instructions.

Do not use solvents, abrasive cleaners, glass cleaners or all-purpose cleaners. These could damage plastic surfaces and other parts. The machine must never be hosed down.

- Dry all parts with a soft cloth.

Cleaning the condenser unit

Detergent residue, hair and fine fluff from the dryer can get through the fluff filters and block the condenser unit. Dust from the room in which the dryer is installed can also get into the condenser unit and cause a blockage.

Check the condenser unit at least twice a year. Always check it if the *Clean out airways* indicator light comes on. If the dryer is used frequently then check the condenser unit after approx. 100 drying cycles. Clean it if necessary.

Removing the condenser unit

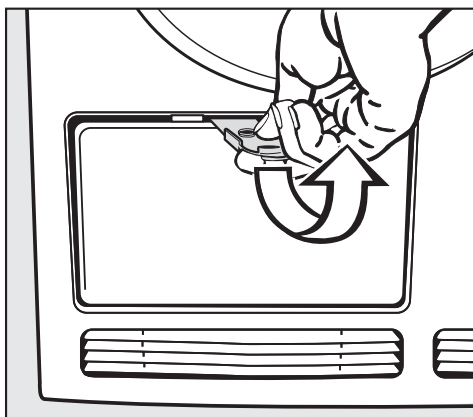

- Open the service panel.
- Now remove the panel by pulling it diagonally upwards and place it to one side.

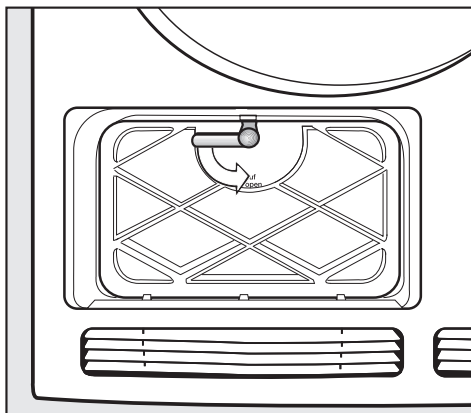

- Turn the lever on the inner cover downwards to the vertical position.
- Tilt the cover forwards.
- Remove it by pulling it diagonally upwards.

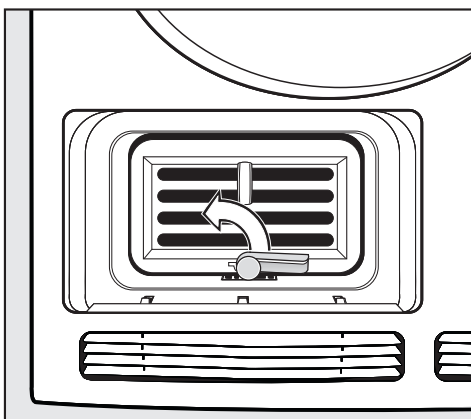

- Turn the lever on the condenser unit upwards to the vertical position.

Cleaning and care

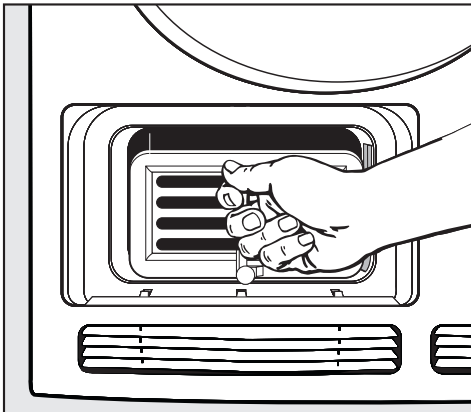

- Pull the condenser unit out of its housing by the handle.

Checking the condenser unit

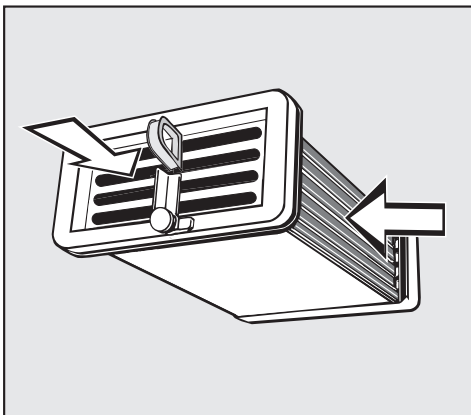

- Hold the condenser unit up to the light **as shown**.
- Check to see if there is any fluff inside it.
The arrows in the illustration above indicate where to look.

If you cannot see any fluff:

- Replace the condenser unit (see following page).

If you can see some fluff:

- Clean the condenser unit as described below.

Cleaning the condenser unit

- **When rinsing the condenser unit, make sure you position it as shown in the next two illustrations.**

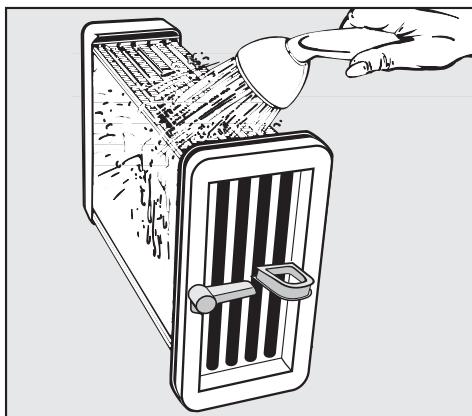

- Use a shower head or similar to rinse the unit out **as shown**.



- Then flush the unit through from the front.
- Check the condenser unit again for any visible fluff and if necessary flush it through again until it has all gone.
- Remove any soiling still visible inside the housing unit.
- Also make sure the rubber seals are clean.
The rubber seals must not be removed and must be free of kinks.
- Shake any excess water out of the unit until no more water droplets are visible.

Replacing the condenser unit

- With the handle facing upwards, push the condenser unit back into position in its housing.
- Turn the lever down to the horizontal position, making sure that the hook on the lever clicks into the groove.

When replacing the inner cover after cleaning, ensure that the rubber seal fits correctly into the groove.

- Replace the cover making sure the hooks locate correctly. Hold it at an angle and push it gently downwards.
- Then turn the lever upwards into the horizontal position to lock the cover.
- Replace the service panel and press the upper edge until it clicks into position.



It is important to ensure that both the condenser unit and the cover are correctly positioned and locked. Otherwise water may leak from the machine.

Problem solving guide

With the help of the following notes, minor faults in the performance of the machine, some of which may result from incorrect operation, can be put right without contacting the Service Department.

 Repair work to electrical appliances should only be carried out by a suitably qualified person in strict accordance with current local and national safety regulations. Repairs and other work by unqualified persons could be dangerous. The manufacturer cannot be held liable for unauthorised work.

Check and fault messages

Problem	Possible cause	Remedy
<p>The programme stops and  appears in the display.</p> <p>The buzzer sounds.</p>	<p>This is not a fault.</p> <p>The electronic unit has recognised that there is no laundry in the drum and cancelled the programme.</p> <p>Drying individual garments or items which are already dry can also cause the programme to be cancelled.</p>	<p>– Use the Warm air programme (timed drying) to dry individual items.</p> <p>To delete the fault message:</p> <p>– Open and close the door.</p>
<p>The <i>Low temperature</i> indicator light starts flashing after the dryer has been switched on and - appears in the display.</p>	<p>The electronic system lock is activated.</p>	<p>You will need to deactivate the system lock before the dryer can be used (see "Electronic system lock").</p>
<p>The programme stops and <i>Cooling down</i> or <i>Finish</i> flashes in the display.</p> <p>The buzzer sounds.</p>	<p>No obvious cause.</p>	<p>– Switch the dryer off and then on again.</p> <p>– Then start the programme again.</p> <p>If the programme stops again and <i>Cooling down</i> or <i>Finish</i> flashes again there is a fault. Contact the Miele Service Department.</p>

Problem solving guide

Problem	Possible cause	Remedy
<p>The <i>Clean out airways</i> indicator light comes on.</p>	<p>This indicator light comes on to warn you that the dryer is not working efficiently.</p> <p>Possible cause: The fluff filters are clogged with fluff or with detergent residues.</p>	<ul style="list-style-type: none"> – Cleaning the fluff filters is usually all that is required. However, if the <i>Clean out airways</i> indicator light does not go out after you have cleaned the filters, then also check all the possible causes described under "The drying process goes on too long or even switches off". <p>To switch off the indicator light:</p> <ul style="list-style-type: none"> – Open and close the door. – Switch the dryer off and then back on again.
		<p>The <i>Clean out airways</i> indicator light can be deactivated (see "Programmable functions").</p>
<p>The programme stops.</p> <p>The <i>Clean out airways</i> indicator light comes on.</p> <p>The buzzer sounds.</p>	<p>See above for possible causes and their remedies.</p>	<p>To switch off the indicator light:</p> <ul style="list-style-type: none"> – Open and close the door. – Switch the dryer off and then back on again. – If the <i>Clean out airways</i> indicator light comes on again, contact the Miele Service Dept.
<p>The <i>Empty out container</i> indicator light comes on.</p> <p>The buzzer sounds.</p>	<p>The condensed water container is full or there is kink in the drain hose.</p>	<ul style="list-style-type: none"> – Empty out the condensed water container. – Check the drain hose. <p>To switch off the indicator light:</p> <ul style="list-style-type: none"> – Open and close the door.

Problem solving guide

Other problems		
Problem	Possible cause	Remedy
<p>The drying process goes on too long or even switches off.</p> <p>In some circumstances, the <i>Clean out airways</i> indicator light still comes on, even though the filters are clean.</p>	<p>Please check all the possible causes and switch the dryer off and then back on again.</p>	
	<p>Ventilation to and from the dryer may be insufficient (e.g. because it is installed in a small room). This has caused the temperature in the room to rise sharply.</p>	<p>Open a door or window while the machine is in operation for increased air flow.</p>
	<p>The fluff filters are clogged up with fluff or were still wet when they were replaced.</p>	<ul style="list-style-type: none"> – Remove any fluff. – The fluff filters must be completely dry.
	<p>The laundry has not been spun sufficiently.</p>	<p>Make sure that your laundry is thoroughly spun at the appropriate spin speed.</p>
	<p>The tumble dryer has been overloaded.</p>	<p>Do not exceed the maximum load for the programme selected.</p>
	<p>Metallic components, e.g. zips have prevented the dryer from registering the correct moisture level in the laundry.</p>	<ul style="list-style-type: none"> – Open zips next time. <p>If the problem occurs again, dry garments with long zips using the Warm air programme (timed drying).</p>
	<p>Detergent residues, hair and fine fibres can block up the condenser unit.</p>	<p>Check the condenser unit from time to time and clean it if necessary.</p>
<p>The vents below the door are blocked.</p>	<p>Remove any objects that are blocking the vents.</p>	
<p>The laundry is not sufficiently dry.</p>	<p>The load consisted of different fabrics.</p>	<ul style="list-style-type: none"> – Finish drying using the Warm air programme. – Select a different programme next time.

Problem solving guide

Problem	Possible cause	Remedy
Water leaks from the machine after the condenser unit has been cleaned.	<ul style="list-style-type: none">– The inner cover of the condenser unit has not been locked properly and/or the condenser unit has not been positioned correctly.– Fluff has collected in the condenser unit housing.	<ul style="list-style-type: none">– Ensure that the condenser unit is positioned correctly and lock the inner cover.– Check the rubber seals.– Use a cloth to remove any visible fluff from the inside of the condenser unit housing.
Items made of synthetic fibres are charged with static electricity after drying.	Synthetic fibres tend to attract static charge.	Static charge can be reduced by adding a fabric conditioner to the final rinse in the washing programme or a fabric conditioner sheet to the load when drying.
There is a build-up of fluff.	Fluff is principally the result of friction when garments are being worn and washed. Machine drying hardly causes any fluff to form and has been established by research institutes to have no appreciable effect on the lifetime of fabric.	Fluff is collected by the fluff filters and can be easily removed (see "Cleaning and Care").

Problem solving guide

Problem	Possible cause	Remedy
The tumble dryer fails to start when switched on.	No obvious cause.	<ul style="list-style-type: none">– Is the dryer switched on?– Is the plug correctly inserted into the socket and switched on?– Is the door closed properly?– Has the fuse or circuit breaker tripped?
The interior drum lighting does not come on.	The lighting switches off automatically (to save energy).	Switch the dryer off and then on again.
	The lamp needs changing.	Change the lamp as described at the end of this section.

Changing the lamp

Disconnect the machine from the mains electricity supply.

- Open the door.

You will find the interior lamp cover at the top of the drum aperture.

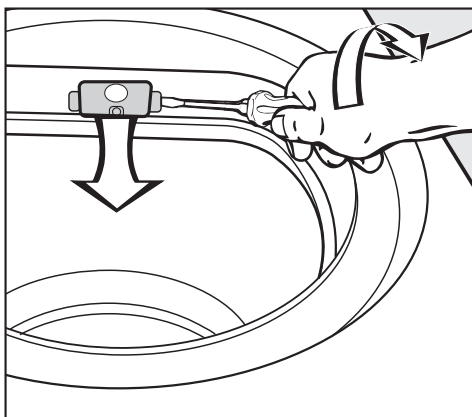

- Insert a suitable tool, such as a wide bladed screwdriver, under the side edge of the lamp cover as illustrated.
- Apply a little pressure and whilst doing so turn your wrist in the direction of the arrow to open the cover.

The cover will open downwards.

The temperature resistant lamp should only be ordered from your Miele dealer or the Miele Spare Parts Department.

The lamp specification and maximum wattage is stated on the data plate and on the lamp cover.

- Replace the lamp.
- To close the cover push it upwards and press it on the left and right until you hear it click into position.

⚠ Ensure that it is fitted into position securely, as any moisture could cause a short circuit.

After Sales service

In the event of any faults which you cannot remedy yourself, please contact

- Your Miele Dealer or
- The nearest Miele Service Department (see back cover for address).

When contacting the Service Department, please quote the Model and Serial numbers both of which are located on the data plate (visible when the door is opened).

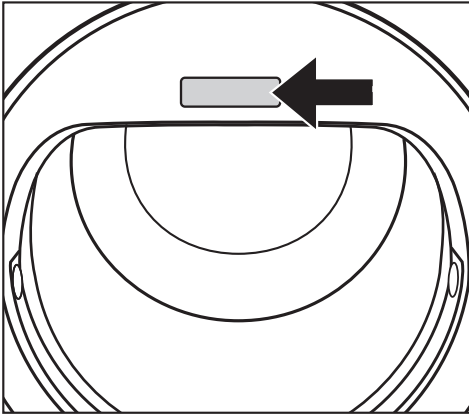

Future updates (PC)

The indicator or check light marked **PC** on the fascia panel is the interface used by the Miele service technicians during service work for testing purposes and for updating the machine's programme data.

Optional accessories

Optional accessories for these dryers are available from your Miele Dealer or from the Miele Spare Parts Department.

Please note that telephone calls may be monitored and recorded to improve our service.

Front view

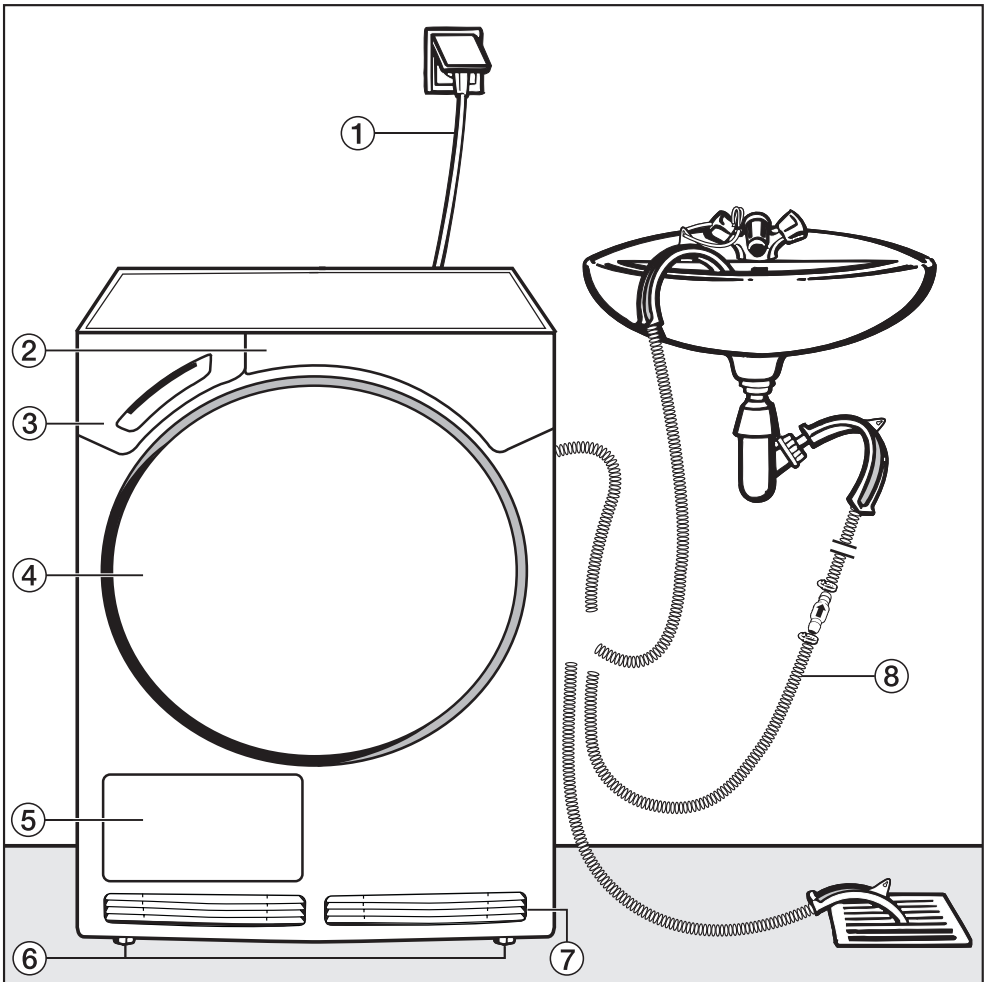

- ① Mains connection cable
- ② Control panel
- ③ Condensed water container
- ④ Door
- ⑤ Service panel for condenser unit
- ⑥ Four height adjustable screw feet
- ⑦ Air inlet and outlet vent for cooling the condenser unit
- ⑧ External drainage options (e.g. via wash basin, wash basin drain outlet or gully)

Installation and connection

Rear view

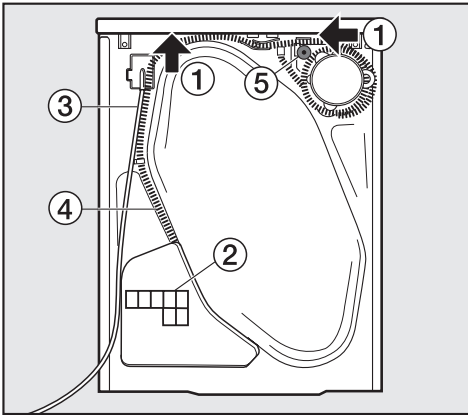

- ① Protruding lid for holding when moving the machine (see arrows)
- ② Air inlet vent for cooling the condenser unit
- ③ Mains connection cable
- ④ External drainage of the condensed water
- ⑤ Accessories for connection to a sink drain outlet

Installation site

 The machine lid must not be removed.

The dryer can be pushed under a worktop with its lid in place, providing the worktop is high enough.

 The appliance must not be installed behind a lockable door, a sliding door or a door with a hinge on the opposite side to that of the tumble dryer, in such a way that a full opening of the tumble dryer door is restricted.

Transporting the machine to its installation site

 Important. The cavity under the lid which can be seen when the condensed water container is removed must not be used to carry or lift the machine. This could damage the machine. Do not hold the machine by the door to carry it.

When moving the machine, hold it by the lid where it protrudes to the rear of the dryer. To manoeuvre the dryer out of its packing case to its installation site you will **also** need to hold it by the front feet.

Washer-dryer stack

The tumble dryer can also be combined with a Miele washing machine in a washer-dryer stack. The appropriate "WTV" stacking kit (available to order) to match your dryer is required.

 Stacking kits must only be installed by a suitably qualified fitter.

Installation and connection

Levelling the machine

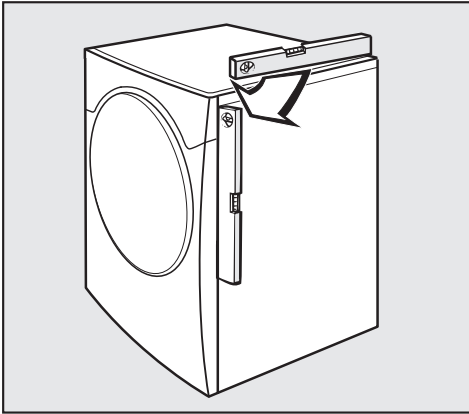

The machine must be perfectly level to ensure safe and proper operation.

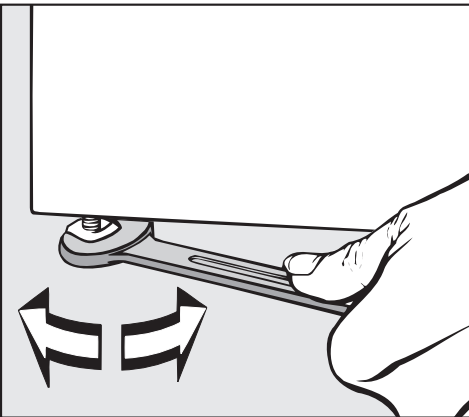

- The screw feet can be adjusted to compensate for any unevenness in the floor.

⚠ The air inlet and outlet vents on the front and back of the machine must not be covered as this would prevent sufficient ventilation for cooling the condenser unit.

⚠ The gap between the base of the dryer and the floor must not be minimised by a plinth or thick-piled carpet as this will prevent a sufficient intake of cold air.

Room ventilation

The air which is taken in when the dryer is in operation is blown out of the vents on the front of the machine and warms up the air in the room. It is very important, particularly if the room is small, to ensure adequate ventilation. Opening a window, for example, will allow more air to enter the room. Otherwise running times and energy consumption could be increased.

Before moving the machine again (e.g. when moving house)

After each use a small quantity of condensed water will collect in the area around the pump. This water can run out if the machine is tipped up when it is being moved. It is a good idea to run the *Cool air* programme for approximately 1 minute before moving the machine. Any remaining condensed water will then be fed into the condensed water container or out through the drain hose.

Installation and connection

External condensed water outlet

General notes

When drying is in progress, condensed water is pumped into the condensed water container through the drain hose at the back of the dryer. The condensed water can also be drained off directly if the machine is installed near a sink, drain outlet etc. so that the condensed water container does not have to be emptied.

Drain hose length 1.50 m
Maximum delivery head 1.50 m
Maximum drain hose length 4.00 m

⚠ If the on-site water drainage system is not fitted with a non-return valve or an appropriate air gap, one must be fitted to prevent the risk of back-flow. (See "Installation conditions requiring a non-return valve").

The following optional accessories are available:

- an extension hose
- a non-return valve kit for connection to an external condensed water outlet (includes an extension hose).
Maximum delivery head with non-return valve fitted: 1.00 m

Arranging the drain hose

⚠ Do not pull on the drain hose and do not stretch it or allow it to become kinked as it could get damaged.

- There will be a small amount of residual water in the drain hose. Have a container ready to collect this.

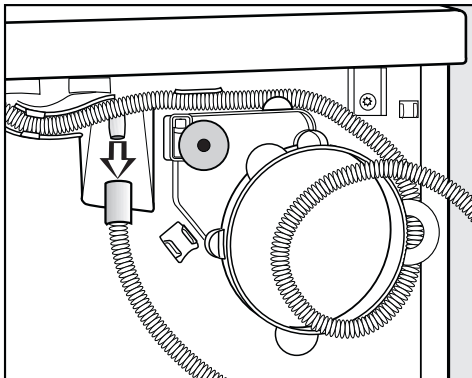

- Pull the hose off its connection (see arrow).
- Allow any residual water to run into the container.
- Unwind the hose and pull it carefully out of the holders.

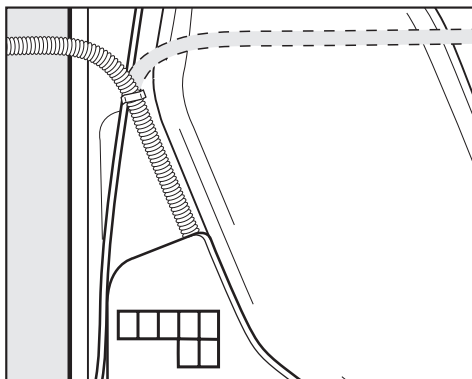

- Position the hose to the right or left hand side as necessary.
- Leave the hose in the middle holder to prevent it from becoming kinked inadvertently.

Installation and connection

External drainage via a sink or gully

- See "Front view" illustration.

 If you want to drain the water off into a sink you will need to secure the hose carefully, e.g. by tying it to a tap to make sure it cannot slip during use. Otherwise there is a risk of overflowing water which could cause damage.

- Use the bow-shaped guide to prevent the drain hose from becoming kinked.

Installation conditions requiring a non-return valve

 Certain installation conditions require the fitting of a non-return valve (available as an optional accessory). A non-return valve will prevent the risk of back-flow out of the dryer which could cause damage.

A non-return valve is required:

- If the tumble dryer is connected to a sink drain outlet (see the following section).
- If the tumble dryer is connected to a drainage system **already in use** by another appliance, e.g. a dishwasher or washing machine.

Example: Connection to a sink drain outlet

The drain hose with non-return valve fitted can be connected directly to a suitable sink drain outlet.

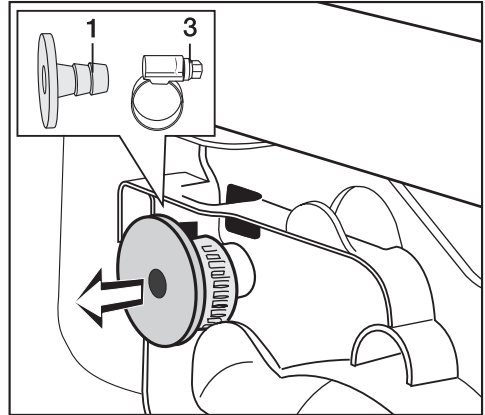

- Remove the following from the back of the dryer at the top:
Adapter **1** and hose clip **3** behind it.

Installation and connection

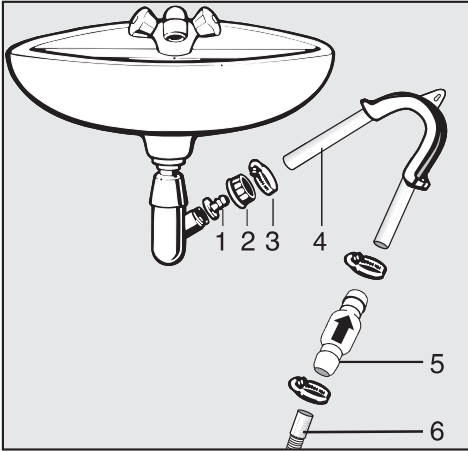

- 1 Adapter
- 2 Nut
- 3 Hose clip
- 4 End of the hose
- 5 Non-return valve
- 6 Tumble dryer drain hose

- Fit adapter **1** to the sink drain outlet using nut **2**.

If this nut has a flat disc in it you should take the disc out first.

- Attach the end of the hose **4** to adapter **1**.
- Use a screwdriver to tighten hose clip **3** up close to the nut.

⚠ Non-return valve **5** has to be fitted with the arrow pointing in the direction of flow (i.e. towards the sink). Otherwise water will not drain out of the machine.

- Fit non-return valve **5** to the tumble dryer drain hose **6** (make sure it is fitted in the correct direction (see arrow on non-return valve).
- Secure the non-return valve using hose clips.

Electrical connection

This tumble dryer is supplied ready for connection to an a.c. single phase supply. The machine is supplied with a mains cable with moulded plug.

The accessibility of the plug must be always ensured, in order to separate the dryer from the mains.

The appliance should be connected up only by a qualified electrician, in accordance with national and local safety regulations.

For extra safety it is advisable to install a residual current device (RCD) with a trip current of 30 mA.

The voltage, rated load and plug rating are given on the data plate. Please ensure that these match the household mains supply.

Important

The wires in the mains lead are coloured in accordance with the following code:

Green/yellow = earth

Blue = neutral

Brown = live

As the colours of the wires in the mains lead of this appliance may not correspond with the coloured markings identifying the terminals in your plug, proceed as follows:

The wire which is coloured green and yellow must be connected to the terminal in the plug which is marked with the letter E or by the earth symbol \perp or coloured green or green and yellow.

The wire which is coloured blue must be connected to the terminal which is marked with the letter N or coloured black.

The wire which is coloured brown must be connected to the terminal which is marked with the letter A or coloured red.

WARNING
THIS APPLIANCE MUST BE
EARTHED

Consumption data

Programme	Load kg*	Final spin speed in a domestic washing machine	Energy kWh	Duration Minutes
		rpm		
Cottons Normal	6.0	1000 (60 % residual moisture)**	3.35	104
		1200	3.05	95
		1400	2.90	91
		1600	2.75	88
		1800	2.50	80
Cottons Hand iron	6.0	1000 (60 % residual moisture)**	2.70	85
		1200	2.40	76
		1400	2.25	71
		1600	2.15	68
		1800	1.85	60
Minimum iron Normal	3.0	1200 (40 % residual moisture)**	1.25	44
Minimum iron Hand iron	3.0	1200	1.00	39
Delicates Normal	2.0	800	1.40	97
Automatic Normal	3.5	800	2.10	96
Shirts Normal	2.0	600	1.25	84
Denim Normal	3.0	900	2.00	99
Woollens handcare	2.0	1000	0.15	4
Smoothing	3.0	1000	0.25	8

* Weight of dry laundry

** EN 61121:2005 test programme

All data without a "star" against it was calculated using EN 61121:2005.

Before testing in accordance with EN 61121, dry a 3 kg load of cotton laundry with 70% residual moisture as per the above standard using the Cottons Normal programme without selecting any additional options.

Consumption data can vary from the nominal values given above depending on the size of the load, types of textiles, residual moisture levels after spinning, fluctuations in the electricity supply and any extra options selected.

Technical data

Height	850 mm
Width	595 mm
Depth	634 mm
Depth with door open	1074 mm
Suitable for pushing under a worktop	Yes
Suitable for stacking	Yes
Weight	52 kg
Drum volume	111 litres
Maximum capacity	6 kg dry weight
Capacity of condensed water container	approx. 3.5 litres
Drain hose length	1.50 m
Maximum delivery head	1.50 m
Maximum drain hose length	4.00 m
Length of connection cable	2.00 m
Voltage	see data plate
Connected load	see data plate
Plug rating	see data plate / plug
Lamp wattage	see data plate / plug
Energy consumption	see "Consumption data"
Test certificates awarded	Electrical safety, C-Tick Mark
Electrically suppressed	AS/NZS 1044

Programmable functions for changing standard settings

The programmable functions are used to alter the machine's electronics to suit changing requirements.
Programmable functions can be altered at any time.

Extending the range of the drying levels

You can extend the range of the drying levels for many of the programmes:

Machine iron+

(drier than Machine iron).

Hand iron+

(drier than Hand iron).

Normal+

(drier than Normal).

In addition the *Extra dry* drying level can be made available for the *Delicates* and *Denim* programmes.

You can use this programmable function to extend the range of the drying levels for the following programmes:

Cottons, *Minimum iron**, *Delicates**, *Automatic*, *Denim*.

* Machine iron+ is not available.

Follow steps 1 to 5 to programme and store in memory.

Before you begin, first ensure that:

- The tumble dryer is switched off.
- The door is closed.

1 Press the *Start/Stop* button and keep it pressed in whilst carrying out steps 2-3.

2 Press the *I-On/O-Off* button in.

Wait until the indicator light for the *Start/Stop* button lights up constantly . . .

3 . . . and then release the *Start/Stop* button.

- The *Low temperature* indicator light will briefly flash on and off twice.
- *P* and *D* (default setting) will flash alternately in the display.

The number which appears alternately in the display with *P* means:

D Default setting

1 Drying level range extended

(The *Automatic* indicator light will also flash).

- 4 Pressing the *Start/Stop* button switches from one to the other.
- 5 Switch the machine off with the *I-On/O-Off* button.

The setting you have selected is now stored in memory. You can change it again at any time.

To select the extended drying level

- Select a programme.
- Press the drying level button repeatedly until one or two indicator lights come on.
 - Indicator lights *Extra dry* and *Normal* = Normal+
 - Indicator lights *Hand iron* and *Normal* = Hand iron+
 - Indicator lights *Machine iron* and *Hand iron* = Machine iron+

Programmable functions

Altering the volume of the buzzer

The buzzer has two volumes.

Normal

The buzzer sounds at the end of a programme (default setting).

Loud

The buzzer sounds at maximum volume at the end of a programme.

Follow steps ① to ⑥ to programme and store in memory.

Before you begin, first ensure that:

- The tumble dryer is switched off.
- The door is closed.

① Press the *Start/Stop* button and keep it pressed in whilst carrying out steps ②-③.

② Press the *I-On/O-Off* button in.

Wait until the indicator light for the *Start/Stop* button lights up constantly . . .

③ . . . and then release the *Start/Stop* button.

④ Press the *Low temperature* button once.

– The *Low temperature* indicator light will briefly flash on and off four times.

– *P* and *U* (default setting) will flash alternately in the display.

The number which appears alternately in the display with *P* means:

***U* Normal buzzer**
(Default setting)

***I* Loud buzzer**
(The *Automatic* indicator light will also flash).

⑤ Pressing the *Start/Stop* button switches from one to the other. You will hear the two buzzer volumes as you do so.

⑥ Switch the machine off with the *I-On/O-Off* button.

The setting you have selected is now stored in memory. You can change it again at any time.

Memory function

The electronics will memorise any additional options selected for a programme.

The duration selected for the Warm air and Cool air programmes and the Delay start period selected will also be stored in memory.

These settings will be selected automatically the next time the programme is chosen. You can either accept these or change them by pressing the appropriate button.

Follow steps ① to ⑥ to programme and store in memory.

Before you begin, first ensure that:

- The tumble dryer is switched off.
- The door is closed.

① Press the *Start/Stop* button and keep it pressed in whilst carrying out steps ②-③.

② Press the *I-On/O-Off* button in.

Wait until the indicator light for the *Start/Stop* button lights up constantly . . .

③ . . . and then release the *Start/Stop* button.

④ Press the *Low temperature* button twice.

– The *Low temperature* indicator light will briefly flash on and off six times.

– *P* and *U* (default setting) will flash alternately in the display.

The number which appears alternately in the display with *P* means:

***U* Memory deactivated**
(Default setting).

***I* Memory activated**
(The *Automatic* indicator light will also flash).

⑤ Pressing the *Start/Stop* button switches from one to the other.

⑥ Switch the machine off with the *I-On/O-Off* button.

The setting you have selected is now stored in memory. You can change it again at any time.

Programmable functions

Extending the cooling down time

The cooling down phase which takes place before the end of a programme can be lengthened if required. This makes the garments easier to handle.

The cooling down time

- can be extended by 5 minutes or 10 minutes.
- is not available for the following programmes: *Woollens handcare*, *Smoothing*, *Warm air*, *Cool air*.

Follow steps ❶ to ❸ to programme and store in memory.

Before you begin, first ensure that:

- The tumble dryer is switched off.
- The door is closed.

❶ Press the *Start/Stop* button and keep it pressed in whilst carrying out steps ❷-❸.

❷ Press the *I-On/O-Off* button in.

Wait until the indicator light for the *Start/Stop* button lights up constantly . . .

❸ . . . and then release the *Start/Stop* button.

❹ Press the *Low temperature* button three times.

– The *Low temperature* indicator light will briefly flash on and off seven times.

– *P* and *U* (default setting) will flash alternately in the display.

The number which appears alternately in the display with *P* means:

U Default setting

1 **The cooling down time will be five minutes longer.**

(The *Automatic* indicator light will also flash once).

2 **The cooling down time will be ten minutes longer.**

(The *Automatic* indicator light will also flash twice).

❺ Pressing the *Start/Stop* button switches from one to the other.

❻ Switch the machine off with the *I-On/O-Off* button.

The setting you have selected is now stored in memory. You can change it again at any time.

Clean out airways indicator

 A clogged filter is a fire hazard!
The lint filter must be cleaned after every program.

Fluff should be removed after drying. The *Clean out airways* indicator will remind you to clean the filters when a certain amount of fluff has collected in the filters. You can decide at what level of fluff this reminder should be given.

You will have an idea of which of the four options to select after a few drying programmes.

Follow steps ① to ⑥ to programme and store in memory.

Before you begin, first ensure that:

- The tumble dryer is switched off.
- The door is closed.

① Press the *Start/Stop* button and keep it pressed in whilst carrying out steps ②-③.

② Press the *I-On/O-Off* button in. Wait until the indicator light for the *Start/Stop* button lights up constantly . . .

③ . . . and then release the *Start/Stop* button.

④ Press the *Low temperature* button four times.

- The *Low temperature* indicator light will flash on and off slowly once.
- *P* and *2* (default setting) will flash alternately in the display.

The number which appears alternately in the display with *P* means:

0 **The *Clean out airways* indicator light is deactivated**

1 **The *Clean out airways* indicator light will come on when there is a heavy build-up of fluff**

(The *Automatic* indicator light will also flash once).

2 **Default setting**

(the *Automatic* indicator light will also flash twice).

3 **The *Clean out airways* indicator light will come on when there is only a light build-up of fluff**

(The *Automatic* indicator light will also flash three times).

5 Pressing the *Start/Stop* button switches from one to the other.

6 Switch the machine off with the *I-On/O-Off* button.

The setting you have selected is now stored in memory. You can change it again at any time.

Programmable functions

Keypad tone

An audible tone sounds each time you select a programme.

Follow steps ① to ⑥ to programme and store in memory.

Before you begin, first ensure that:

- The tumble dryer is switched off.
- The door is closed.

① Press the *Start/Stop* button and keep it pressed in whilst carrying out steps ②-③.

② Press the *I-On/O-Off* button in.

Wait until the indicator light for the *Start/Stop* button lights up constantly . . .

③ . . . and then release the *Start/Stop* button.

④ Press the *Low temperature* button five times.

– The *Low temperature* indicator light will flash on and off slowly once and will then flash on and off quickly once.

– *P* and *U* (default setting) will flash alternately in the display.

The number which appears alternately in the display with *P* means:

***U* Keypad tone deactivated**
(Default setting)

***I* Keypad tone activated**
(The *Automatic* indicator light will also flash)

⑤ Pressing the *Start/Stop* button switches from one to the other.

⑥ Switch the machine off with the *I-On/O-Off* button.

The setting you have selected is now stored in memory. You can change it again at any time.

Adjusting the dryer's electronics for very soft water

 In some areas, water is extremely soft which can affect the sensitivity of the control electronics. If the machine is installed in an area with very soft water, you should contact your local water supplier for information and advice regarding water hardness and water conductivity. If the water conductivity is less than 150 µS, the following programmable function will need to be activated.

Important. This programmable function should not be activated if, despite the water being extremely soft (as would be the case if a water softener were used), its conductivity is greater than 150 µS.

Follow steps ① to ⑥ to programme and store in memory.

Before you begin, first ensure that:

- The tumble dryer is switched off.
- The door is closed.

① Press the *Start/Stop* button and keep it pressed in whilst carrying out steps ②-③.

② Press the *I-On/O-Off* button in.

Wait until the indicator light for the *Start/Stop* button lights up constantly . . .

③ . . . and then release the *Start/Stop* button.

④ Press the *Low temperature* button six times.

– The *Low temperature* indicator light will flash on and off slowly once and will then flash on and off quickly twice.

– *P* and *U* (default setting) will flash alternately in the display.

The number which appears alternately in the display with *P* means:

U Default setting

I Adjusted for very soft water

(with low conductivity)

(The *Automatic* indicator light will also flash)

⑤ Pressing the *Start/Stop* button switches from one to the other.

⑥ Switch the machine off with the *I-On/O-Off* button.

The setting you have selected is now stored in memory. You can change it again at any time.



Miele Australia Pty. Ltd.

ABN 96 005 635 398

Melbourne:

1 Gilbert Park Drive

Knoxfield, VIC 3180

Telephone: (03) 9764 7130

Fax: (03) 9764 7149

Sydney:

3 Skyline Place

Frenchs Forest, NSW 2086

Telephone: (02) 8977 4230

Fax: (02) 8977 4249

Brisbane:

39 Harvey Street North

Eagle Farm, QLD 4009

Telephone: 1800 798 578

Fax: 1800 799 578

Adelaide:

79-81 Sir Donald Bradman Drive

Hilton, SA 5033

Telephone: 1800 018 770

Fax: 1800 799 578

Perth:

205-207 Stirling Highway

Claremont, WA 6010

Telephone: 1800 094 872

Fax: 1800 799 578

www.miele.com.au

Miele New Zealand Limited

Unit L, 10-20 Sylvia Park Road
Mt. Wellington, 1060, Auckland
New Zealand

Telephone: 0800 264 353

Fax: 0800 463 453

www.miele.co.nz

Germany

Miele & Cie. KG

Carl-Miele-Straße 29

33332 Gütersloh