

# Operator's manual SILENO/SILENO+

R100Li, R100LiC/R130Li, R130LiC, R160Li





<b>1 Introduction and safety</b>	<b>3</b>		
1.1 Introduction	3	9.2 Info messages	72
1.2 Symbols on the product	4	9.3 Indicator lamp in the charging station	73
1.3 Symbols in the Operator's Manual	6	9.4 Symptoms	73
1.4 Safety instructions	6	9.5 Finding breaks in the loop wire	75
<b>2 Presentation</b>	<b>10</b>	<b>10 Technical Data</b>	<b>78</b>
2.1 What is what?	11	<b>11 Guarantee terms</b>	<b>79</b>
2.2 Package content	12	<b>12 Environmental information</b>	<b>80</b>
2.3 Function	12	<b>13 EC Declaration of Conformity</b>	<b>81</b>
<b>3 Installation</b>	<b>15</b>		
3.1 Preparations	15		
3.2 Installation of the charging station	16		
3.3 Charging the battery	20		
3.4 Installation of the boundary wire	21		
3.5 Connecting the boundary wire	27		
3.6 Installation of the guide wire	28		
3.7 Checking the installation	31		
3.8 First start-up and calibration	32		
3.9 Test docking with the charging station	32		
<b>4 Use</b>	<b>34</b>		
4.1 Charging a flat battery	34		
4.2 Using the timer	35		
4.3 Standby	36		
4.4 Starting	37		
4.5 Stopping	37		
4.6 Switching off	37		
4.7 Adjusting the cutting height	38		
<b>5 Control panel</b>	<b>39</b>		
5.1 Operation selection Start	40		
5.2 Operation selection Parking	41		
5.3 Main switch	41		
<b>6 Menu functions</b>	<b>42</b>		
6.1 Main menu	42		
6.2 Menu structure	43		
6.3 Timer	44		
6.4 Security	47		
6.5 SensorControl	48		
6.6 Smart System	49		
6.7 Installation	51		
6.8 Settings	56		
<b>7 Garden examples</b>	<b>58</b>		
<b>8 Maintenance</b>	<b>63</b>		
8.1 Winter storage	63		
8.2 After winter storage	64		
8.3 Cleaning	64		
8.4 Transport and moving	66		
8.5 In the event of a thunderstorm	66		
8.6 Blades	66		
8.7 Software update	67		
8.8 Battery	68		
<b>9 Troubleshooting</b>	<b>69</b>		
9.1 Fault messages	69		



---

## MEMO

---

Serial number: \_\_\_\_\_

PIN code: \_\_\_\_\_

Product registration key: \_\_\_\_\_

The Product Registration Key is a valuable document and must be stored in a safe place. This key is necessary for example to register the product on GARDENA's website or to unlock the robotic lawnmower in the event of a lost PIN code. The product registration key is provided in a separate document in the product packaging.

If the robotic lawnmower is stolen, it is important to notify GARDENA of this. Contact GARDENA Central Service and provide the robotic lawnmower's serial number and product registration key so that it can be registered as stolen in an international database. This is an important step in the robotic lawnmower's theft protection which reduces interest in the buying and selling of stolen mowers.

Always have the robotic lawnmower's serial number at hand when you contact GARDENA Central Service, as this will provide you with faster support.

**GARDENA Central Service**

**[www.gardena.com](http://www.gardena.com)**

## 1 Introduction and safety

### 1.1 Introduction

Congratulations on your choice of an exceptionally high quality product. To get the best results from your GARDENA robotic lawnmower requires knowledge of how it works. This Operator's Manual contains important information about the robotic lawnmower, how it must be installed and how to use it. The following instructions covers all GARDENA Sileno and Sileno+ products. Within the Sileno family you find R100Li and R100LiC. Within the Sileno+ family you find R130Li, R130LiC and R160Li. This instruction will hereby refer to the model specific names

As a complement to this Operator's Manual, there are more information movies with instructions available on the GARDENA's website, [www.gardena.com](http://www.gardena.com). Here you can find more help and guidance in its use.

Keep in mind that the operator is responsible for accidents or hazards occurring to other people or their property.

GARDENA has a policy of continuous product development and therefore reserves the right to modify the design, appearance and function of products without prior notice.

The following system is used in the Operator's Manual to make it easier to use:

- Text written in *italics* is a text that is shown on the robotic lawnmower's display or is a reference to another section in the Operator's Manual.
- Words written in **bold** are one of the buttons on the robotic lawnmower's keypad.
- Words written in *UPPERCASE* and *italics* refer to the position of the main switch and the different operating modes available in the robotic lawnmower.

#### IMPORTANT INFORMATION

**Please read the Operator's Manual carefully and make sure you understand the instructions before using the robotic lawnmower. Keep the Operator's manual in a safe way for future reference!**

**This appliance is not intended for use by persons (including children) with reduced physical, sensory or mental capabilities, or lack of experience and knowledge, unless they have been given supervision or instruction concerning use of the appliance by a person responsible for their safety. Children should be supervised to ensure that they do not play with the appliance.**

[www.gardena.com](http://www.gardena.com)



1001-003

# INTRODUCTION AND SAFETY

## IMPORTANT INFORMATION

This appliance can be used by children aged from 8 years and above and persons with reduced physical, sensory or mental capabilities or lack of experience and knowledge if they have been given supervision or instruction concerning use of the appliance in a safe way and understand the hazards involved.

Children shall not play with the appliance. Cleaning and user maintenance shall not be made by children without supervision.



### WARNING

The robotic lawnmower can be dangerous if used incorrectly.



### WARNING

Never use the robotic lawnmower when persons, especially children, or pets, are in the cutting area.

## 1.2 Symbols on the product

These symbols can be found on the robotic lawnmower. Study them carefully.

- Please read the Operator's Manual carefully and make sure you understand the instructions before using the robotic lawnmower. The warnings and safety instructions in this Operator's Manual must be carefully followed if the robotic lawnmower is to be used safely and efficiently.
- The robotic lawnmower can only start when the main switch is set to 1 and the correct PIN code has been entered. Turn the main switch to 0 before carrying out any inspections and/or maintenance.
- Remain at a safe distance from the robotic lawnmower when it is running. Keep your hands and feet away from the rotating blades.

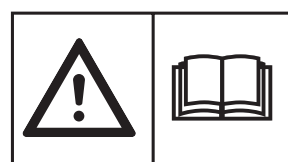

3018-173

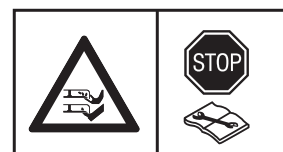

3018-174



3018-066

# INTRODUCTION AND SAFETY

- Never put your hands or feet close to or under the body when the robotic lawnmower is running. Do not ride on the robotic lawnmower.



3012-665

- Lock function



3018-244

- This product conforms to the applicable EC Directives.



6001-024

- Noise emission to surroundings. The product's emissions are set out in chapter 10, *Technical data* and on the rating plate.

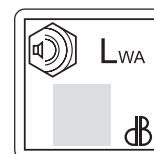

3012-1059

- It is not permitted to dispose of this product as normal household waste when it has reached the end of its useful life. Ensure that the product is recycled in accordance with local legal requirements.



3032-019

- Never use a high-pressure washer or even running water to clean the robotic lawnmower.

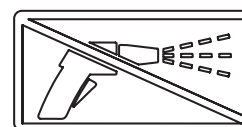

3018-243

- The chassis contains components which are sensitive to electrostatic discharge (ESD). The chassis is also a significant part of the robotic lawnmower's design and must be resealed in a professional manner if the product is to be used outdoors. For this reason the chassis can only be opened by authorized service technicians. A broken seal can result in the entire or parts of the guarantee no longer being valid.



3012-1097

- The low voltage cable must not be shortened, extended or spliced.
- Do not use a trimmer nearby the low voltage cable. Be careful when trimming edges where the cables are placed.

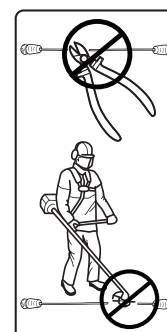

3012-1351

# INTRODUCTION AND SAFETY

## 1.3 Symbols in the Operator's Manual

These symbols can be found in the Operator's Manual. Study them carefully.

- Turn the main switch to 0 before carrying out any inspections and/or maintenance.
- Always wear protective gloves when working with the robotic lawnmower's chassis.
- Never use a high-pressure washer or even running water to clean the robotic lawnmower.
- A warning box indicates the risk of personal injury, especially if the instructions are not followed.
- An information box indicates the risk of material damage, especially if the instructions are not followed. The box is also used where there is a risk of user error.

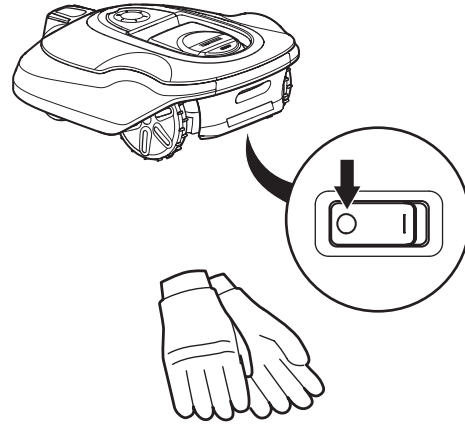

3018-213

3012-272

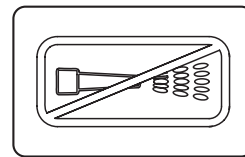

3018-062

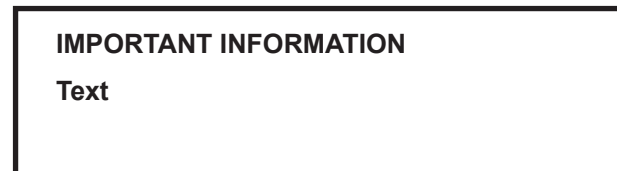
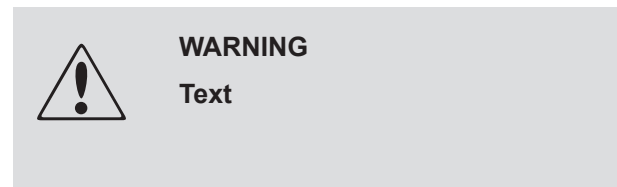

## 1.4 Safety instructions

### Use

- This robotic lawnmower is designed to mow grass in open and level ground areas. It may only be used with the equipment recommended by the manufacturer. All other types of use are incorrect. The manufacturer's instructions with regard to operation/maintenance and repair must be followed precisely.
- Use the **PARK** function or switch off the main switch on the robotic lawnmower when persons, especially children, or pets, are in the cutting area. If there are persons, or pets, in the cutting area it is recommended that the lawnmower be programmed for use during hours when the area is free from persons, e.g. at night. See 6.3 *Timer on page 43*.



1001-003

# INTRODUCTION AND SAFETY

- The robotic lawnmower may only be operated, maintained, and repaired by persons that are fully conversant with its special characteristics and safety regulations. Please read the Operator's Manual carefully and make sure you understand the instructions before using the robotic lawnmower.
- It is not permitted to modify the original design of the robotic lawnmower. All modifications are made at your own risk.
- Check that there are no stones, branches, tools, toys or other objects on the lawn that can damage the blades. Objects on the lawn can also lead to the robotic lawnmower getting stuck in them and help may be required to remove the object before the mower can continue mowing.
- Start the robotic lawnmower according to the instructions. When the main switch is set to 1; make sure to keep your hands and feet away from the rotating blades. Never put your hands and feet under the robotic lawnmower.
- Never lift up the robotic lawnmower or carry it around when the main switch is in position 1.
- Do not let persons who do not know how the robotic lawnmower works and behaves use it.
- The robotic lawnmower must never be allowed to collide with persons or other living creatures. If a person or other living creature comes in the lawnmower's way it shall be stopped immediately. See *4.5 Stopping on page 35*.
- Do not put anything on top of the robotic lawnmower or its charging station.
- Do not allow the robotic lawnmower to be used with a defective blade disc or body. Neither should it be used with defective blades, screws, nuts or wires.
- Do not use the robotic lawnmower if the main switch does not work.
- Always switch off the robotic lawnmower using the main switch when the robotic lawnmower is not in use. The robotic lawnmower can only start when the main switch is set to 1 and the correct PIN code has been entered.
- The robotic lawnmower must never be used at the same time as a sprinkler. Use the timer function (see *6.3 Timer on page 43*) so the mower and sprinkler never run simultaneously.
- GARDENA does not guarantee full compatibility between the robotic lawnmower and other types of wireless systems such as remote controls, radio transmitters, hearing loops, underground electric animal fencing or similar.
- The built-in alarm is very loud. Be careful, especially if the robotic lawnmower is handled indoors.

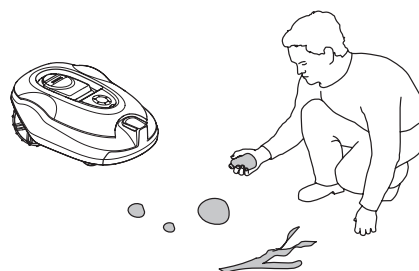

3018-201



3012-663



## INTRODUCTION AND SAFETY

### Moving

The original packaging should be used when transporting the robotic lawnmower over long distances.

To safely move from or within the working area:

1. Press the **STOP** button to stop the robotic lawnmower. If security is set to the medium or high level (see 6.4 Security on page 47) the PIN code has to be entered. The PIN code has four digits and is chosen when the robotic lawnmower is started for the first time, see 3.8 First start-up and calibration on page 32.
2. Set the main switch to position 0.
3. Carry the robotic lawnmower by the handle found at the rear of the product. Carry the robotic lawnmower with the blade disc away from the body.

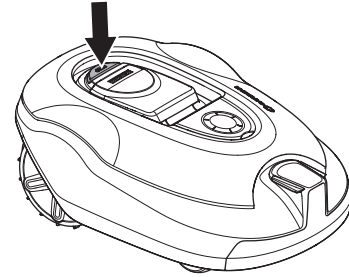

3018-202

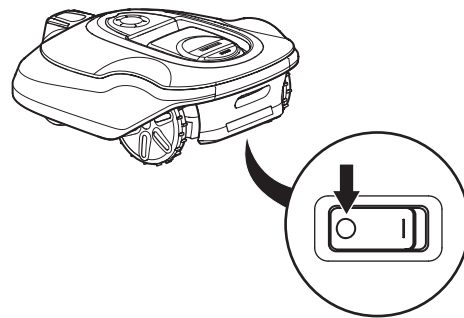

3018-213

#### IMPORTANT INFORMATION

**Do not lift the robotic lawnmower when it is parked in the charging station. It can damage the charging station and/or the robotic lawnmower. Press STOP and instead first pull the robotic lawnmower out of the charging station before lifting it.**

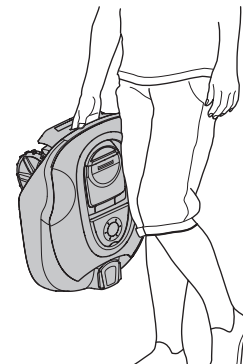

3012-219



# INTRODUCTION AND SAFETY

## Maintenance



### WARNING

When the robotic lawnmower is turned upside down the main switch must always be in the 0 position.

The main switch should be set in the 0 position during all work on the mower's chassis, such as cleaning or replacing the blades.

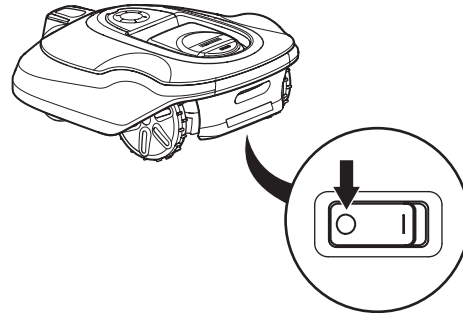

3018-213

### IMPORTANT INFORMATION

Never use a high-pressure washer or even running water to clean the robotic lawnmower. Never use solvents for cleaning.

Inspect the robotic lawnmower each week and replace any damaged or worn parts. The following must be carried out in the weekly inspections:

- Clean the charging station from grass, leaves, twigs and other objects that may impede the robotic lawnmower from docking with the charging station.
- Set the main switch to position 0 and put on a pair of protective gloves. Turn the robotic lawnmower upside down. Check the following:
  1. Clean the drive wheels. Grass in the drive wheels can impact on how the lawnmower works on slopes.
  2. Clean the front wheels. Grass on the front wheels and the front wheel axles can affect performance.
  3. Clean the body, chassis and cutting system. Grass, leaves and other objects that weigh down the product affect performance.
  4. Check that all mower blades are intact. Check also that the mower blades can pivot freely. Even if the mower blades are intact, they must be replaced on a regular basis for the best mowing result and low energy usage. Replace all blades and screws at the same time if necessary so that the rotating parts are kept balanced. See 8.6 *Blades* on page 66

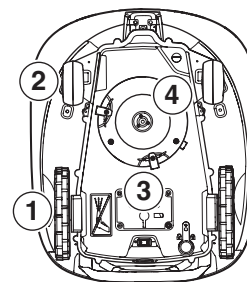

3018-226

# PRESENTATION

## 2 Presentation

This chapter contains information that is important to be aware of when planning the installation.

Installing a robotic lawnmower involves four main components:

- A robotic lawnmower that mows the lawn by essentially operating in a random pattern. The robotic lawnmower is powered by a maintenance-free battery.
- A charging station, to where the robotic lawnmower automatically returns when the charge level in the battery becomes too low. The charging station has three functions:
  - To send control signals along the boundary wire.
  - To send control signals along the guide wire.
  - To charge the battery in the robotic lawnmower.
- A power supply, which is connected between the charging station and a 100V-240V wall socket. The power supply is connected to the wall socket and to the charging station using a 10 m long low voltage cable. The low voltage cable must not be shortened or extended.

A longer low voltage cable is available as optional accessory. Please contact GARDENA Central Service for more information.

The appearance of the power supply may differ depending on market.

- A loop wire, laid in a loop around the robotic lawnmower's working area. The loop wire is laid around the edges of the lawn and around objects and plants that the robotic lawnmower must not run into. The loop wire is also used as the guide wire.

The wire supplied for the installation is:

	R100Li, R100LiC	R130Li, R130LiC	R160Li
Wire length, m	200	250	250

If this is not sufficient, more wire can be purchased and spliced onto the existing wire with a coupler.

The maximum permitted length for the boundary loop is 800 m.

### IMPORTANT INFORMATION

**Always use genuine spare parts and accessories**

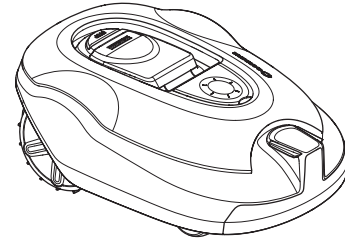

3018-203

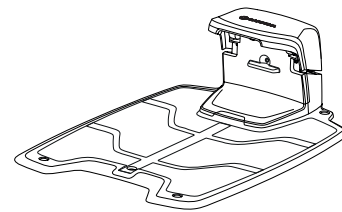

3012-1041

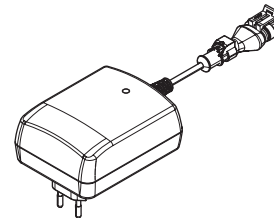

3012-1352

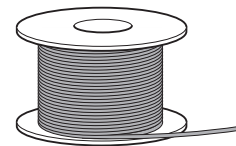

3012-221

# PRESENTATION

## 2.1 What is what?

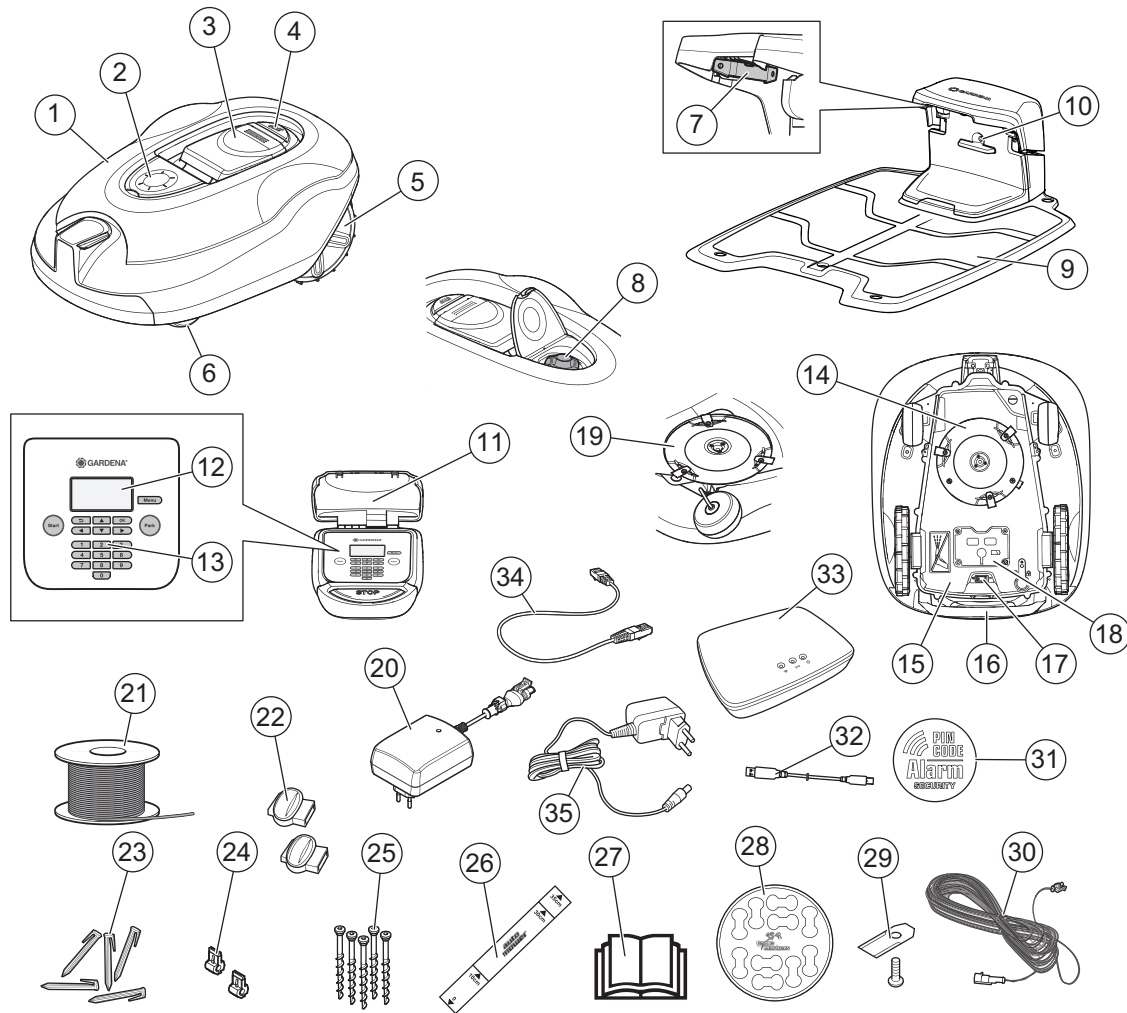

3018-230

The numbers in the illustration represent:

1. Body
2. Hatch to cutting height adjustment
3. Hatch to display and keypad
4. Stop button/Catch to open the hatch
5. Rear wheels
6. Front wheels
7. Contact strips
8. Cutting height adjustment
9. Charging station
10. LED for operation check of the charging station, boundary wire and guide wire
11. Rating plate
12. Display
13. Keypad
14. Cutting system
15. Chassis box with electronics, battery and motors
16. Handle
17. Main switch
18. Battery cover
19. Blade disc
20. Power supply (the appearance of the power supply may differ depending on market)
21. Loop wire for boundary loop and guide wire
22. Couplers for loop wire
23. Pegs
24. Connector for the loop wire
25. Screws for securing the charging station
26. Measurement gauge for help when installing the boundary wire (the measurement gauge is broken loose from the box)
27. Operator's Manual and Quick Guide
28. Cable markers
29. Extra blades
30. Low voltage cable
31. Alarm decal
32. USB cable for Software-Updates
33. Smart System Gateway (only for GARDENA R100LiC, R130LiC)
34. Smart System Gateway LAN-cable (only for GARDENA R100LiC, R130LiC)
35. Smart System Gateway power supply (only for GARDENA R100LiC, R130LiC)

English - 11

# PRESENTATION

## 2.2 Package content

Your GARDENA robotic mower package will include the following parts.

	GARDENA				
	R100Li	R100LiC	R130Li	R130LiC	R160Li
Robotic lawnmower	√	√	√	√	√
Charging station	√	√	√	√	√
Power supply	√	√	√	√	√
Loop wire	200 m	200 m	250 m	250 m	250 m
Couplers	7 pcs	7 pcs	7 pcs	7 pcs	7 pcs
Pegs	400 pcs	400 pcs	400 pcs	400 pcs	400 pcs
Connectors	5 pcs	5 pcs	5 pcs	5 pcs	5 pcs
Charging station screws	5 pcs	5 pcs	5 pcs	5 pcs	5 pcs
Allen key	√	√	√	√	√
Measurement gauge	√	√	√	√	√
Low voltage cable	√	√	√	√	√
Operator's Manual and Quick Guide	√	√	√	√	√
Cable markers	√	√	√	√	√
Extra blades	9 pcs	9 pcs	9 pcs	9 pcs	9 pcs
Alarm decal	√	√	√	√	√
USB cable for Software-Updates	√	√	√	√	√
Smart System Gateway		√		√	
Smart System Gateway LAN-cable		√		√	
Smart System Gateway power supply		√		√	

## 2.3 Function

### Capacity

The robotic lawnmower is recommended for lawns up to:

	R100Li, R100LiC	R130Li, R130LiC	R160Li
<b>Lawn area, m²</b>	1000	1300	1600

How big an area the robotic lawnmower can keep cut depends primarily on the condition of the blades and the type, growth and moisture of the grass. The shape of the garden is also significant. If the garden mainly consists of open lawn areas, the robotic lawnmower can mow more per hour than if the garden consists of several small lawns separated by trees, flower beds and passages.

A fully charged robotic lawnmower mows for 60 to 80 minutes, depending on the age of the battery and how thick the grass is. Then the robotic lawnmower will charge for 60 to 70 minutes. The charging time can vary depending on, among other factors, the ambient temperature.

# PRESENTATION

## Mowing technique

The cutting system in the robotic lawnmower is based on an efficient and energy saving principle. Unlike many standard lawnmowers, the robotic lawnmower cuts the grass instead of knocking it off.

We recommend you allow the robotic lawnmower to mainly mow in dry weather to obtain the best possible result. GARDENA's robotic lawnmowers can also mow in the rain, however, wet grass easily sticks on the robotic lawnmower and there is a greater risk of slipping on steep slopes.

The blades must be in good condition to obtain the best mowing result. In order to keep the blades sharp for as long as possible it is important to keep the lawn free from branches, small stones and other objects which can damage the blades.

Replace the blades regularly for the best mowing result. It is very easy to replace the blades. See 8.6 *Blades on page 66*.

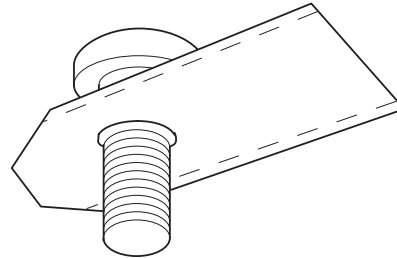

3020-002

## Working method

The robotic lawnmower automatically mows the lawn. It continuously alternates between mowing and charging.

The robotic lawnmower starts to search for the charging station when the battery charge becomes too low. The robotic lawnmower does not mow when it is searching for the charging station.

When the robotic lawnmower is searching for the charging station, it first searches irregularly for the guide wire. Then it follows the guide wire to the charging station.

When the battery is fully charged, the robotic lawnmower will leave the charging station and start mowing in a predefined area in the garden. You might have to set manual exit settings to make sure that the lawn will be cut evenly, see 6.7 *"Installation" on page 51*.

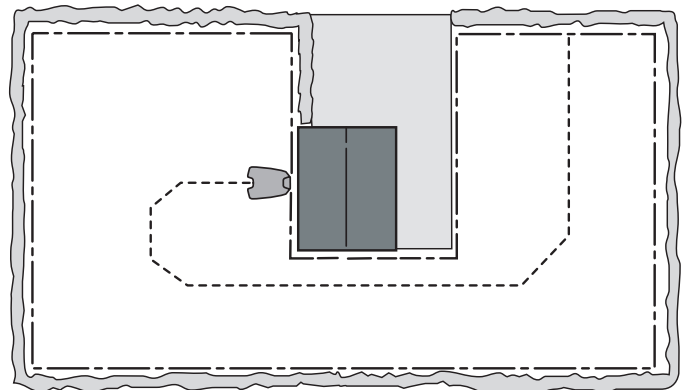

3023-003

When the robotic lawnmower body hits an obstacle, the robotic lawnmower reverses and selects a new direction.

Sensors at the front and back will sense when the robotic lawnmower is approaching the boundary wire. The robotic lawnmower travels up to 32 centimetres beyond the wire before it turns around.

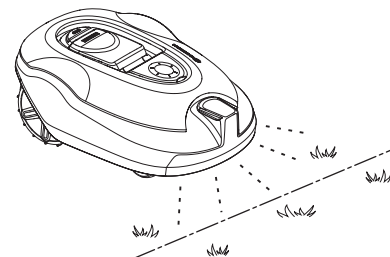

3018-204

# PRESENTATION

The **STOP** button on the top of the robotic lawnmower is mainly used to stop the robotic lawnmower when it's running. When the **STOP** button is pressed a hatch opens, behind which there is a control panel. The **STOP** button remains pressed in until the hatch is closed again. This together with the **START** button acts as a start inhibitor.

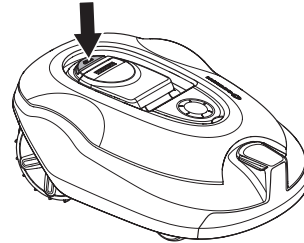

3018-202

The control panel on the top of the robotic lawnmower is where you manage all the robotic lawnmower settings.

When the main switch is set to 1 for the first time, a start-up sequence begins which includes a number of important basic settings. See 3.8 *First start-up and calibration* on page 32.

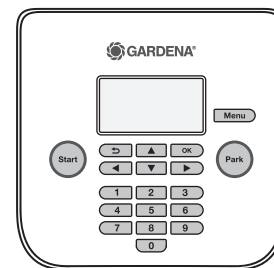

3018-239

## Movement pattern

The movement pattern of the robotic lawnmower is random and is determined by the robotic lawnmower itself. A movement pattern is never repeated. With this cutting system the lawn is mown very evenly without any mowing lines from the robotic lawnmower.

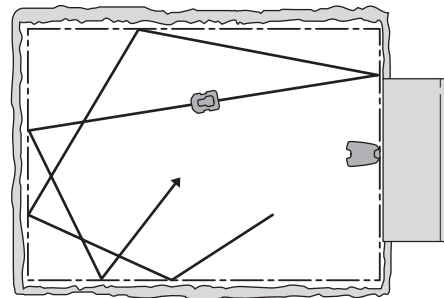

3023-012

## Search method

The robotic lawnmower operates irregularly until it reaches the guide wire. Then the robotic lawnmower follows the guide wire to the charging station.

The guide wire is a wire that is laid from the charging station towards, for instance, a remote part of the working area or through a narrow passage to be then connected with the boundary loop. See 3.6 *Installation of the guide wire* on page 28.

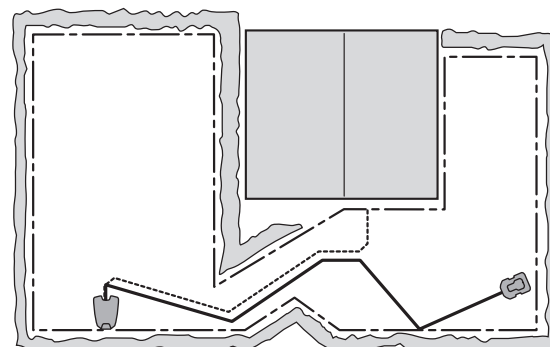

3023-013

## 3 Installation

This chapter describes how to install the robotic lawnmower. Before starting the installation read the previous chapter 2. *Presentation*.

Read also through this entire chapter before beginning the installation. How the installation is done also affects how well the robotic lawnmower works. It is therefore important to plan the installation carefully.

Planning is simplified if you make a sketch of the working area, including all obstacles. This makes it easier to see the ideal positions for the charging station, the boundary wire and the guide wire. Draw on the sketch where the boundary and guide wires should be routed.

See 7 *Garden examples on page 58* for installation examples.

Visit also [www.gardena.com](http://www.gardena.com) for further descriptions and tips regarding installation.

### Carry out the installation as outlined in the following steps:

- 3.1 Preparations
- 3.2 Installation of the charging station
- 3.3 Charging the battery
- 3.4 Installation of the boundary wire
- 3.5 Connecting the boundary wire
- 3.6 Installation of the guide wire
- 3.7 Checking the installation
- 3.8 First start-up and calibration
- 3.9 Test docking with the charging station

The charging station, boundary loop and guide wire must be connected to be able to carry out a complete start-up.

### 3.1 Preparations

1. If the lawn in the working area is longer than 10 cm mow it using a standard lawnmower. Then collect the grass.
2. Fill in holes and hollows to stop rainwater forming pools of water. The product may be damaged if it is operated in pools of water. See 11 *Guarantee terms on page 79*.
3. Read carefully through all the steps before the installation.

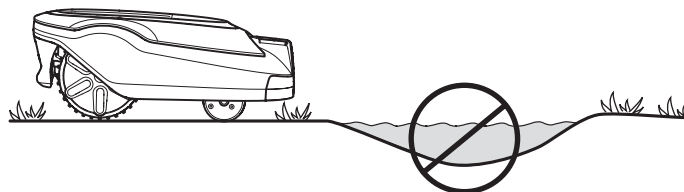

3018-212

# INSTALLATION

4. Check that all parts for the installation are included. The numbers in brackets refer to the component illustration. See 2.1 *What is what?* on page 11.

- Robotic lawnmower
- Charging station (10)
- Loop wire for boundary loop and guide wire (22)
- Power supply (21)
- Low voltage cable (30)
- Pegs (23)
- Connectors for the loop wire (24)
- Screws for the charging station (25)
- Measurement gauge (26)
- Couplers for the loop wire (22)
- Cable markers (28)

During installation you will also need:

- Hammer/plastic mallet (to simplify putting the pegs in the ground).
- Combination pliers for cutting the boundary wire and pressing the connectors together.
- Polygrip (for pressing the couplers together).
- Edge cutter/straight spade if the boundary wire must be buried.

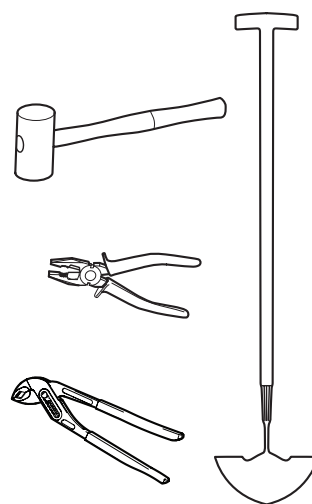

3012-1311

## 3.2 Installation of the charging station

### Best charging station location

Take the following aspects into consideration when identifying the best location for the charging station:

- Allow for at least 3 metres of free space in front of the charging station.
- It must be close to a wall socket. The supplied low voltage cable is 10 metres long.
- A level surface free from sharp objects to place the charging station on.
- Protection from water spray for instance from irrigation.
- Protection from direct sunlight.
- Possible requirement to keep the charging station out of sight for outsiders.



# INSTALLATION

The charging station must be positioned with a great deal of free space in front of it (at least 3 metres). It should also be centrally placed in the working area to make it easier for the robotic lawnmower to reach all areas in the working area.

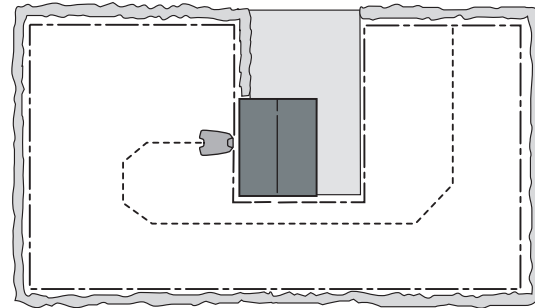

Do not put the charging station in confined spaces in the working area. This can make it difficult for the robotic mower to find the charging station.

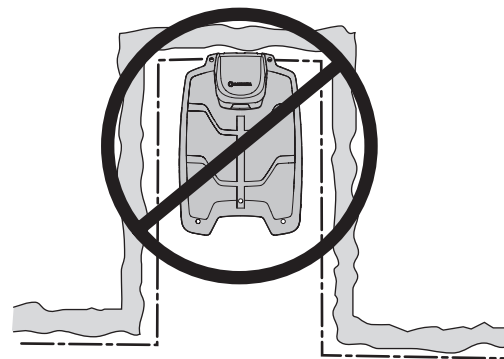

3023-003

The charging station must be positioned on relatively level ground. The front end of the charging station must be a maximum of 5 cm higher or lower than the back end.

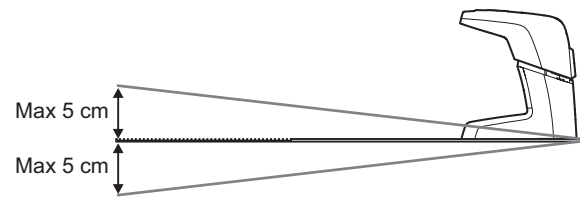

3018-238

The charging station must not be positioned in a way that can bend its base plate.

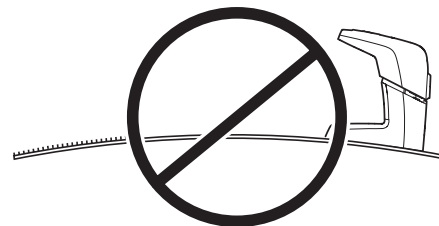

3012-1312

3012-1053

The charging station should not be placed on an island as this limits the laying of the guide wire in an optimal way. If the charging station has to be installed on an island, the guide wire also has to be connected to the island. See the illustration. Read more about islands in the 3.4 Installation of the boundary wire chapter.

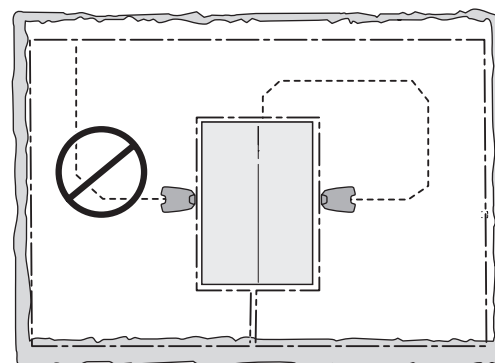

3023-004



# INSTALLATION

## Connecting the power supply

Take the following into consideration when planning where to place the power supply:

- Close to the charging station
- Protection from rain
- Protection from direct sunlight

If the power supply is connected to an electrical socket outdoors, this must be approved for outdoor use.

The low voltage cable for the power supply is 10 metres long, and may not be shortened or extended.

It is not allowed to connect the power supply directly to the charging station. The low voltage cable must always be used.

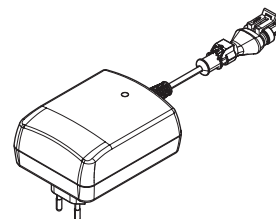

3012-1352

### IMPORTANT INFORMATION

**The low voltage cable must not under any circumstances be shortened or extended.**

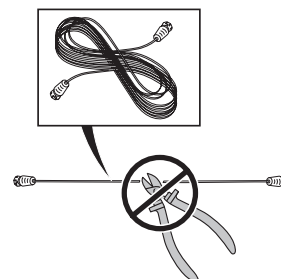

3018-069

It is possible to let the low voltage cable cross the working area. The low voltage cable must be stapled down or buried.

Make sure the low voltage cable is laid along the ground and secured with pegs. The cable must lie close to the ground so as not to be cut before the grass roots have grown over it.

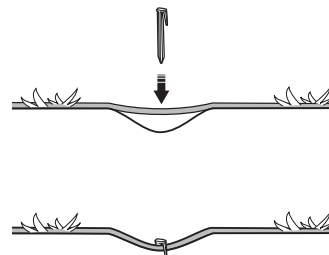

3018-085

### IMPORTANT INFORMATION

**Place the low voltage cable so that the blades on the blade disc can never come in contact with it.**

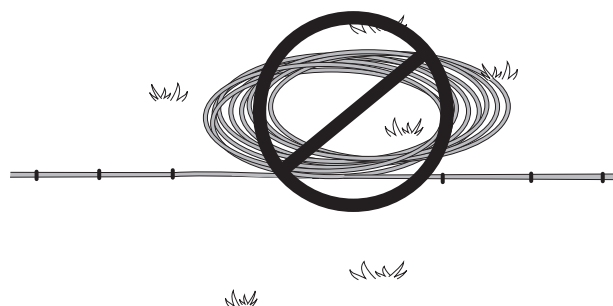

3012-281

The power supply must be placed where it is well ventilated and is not exposed to direct sunlight. The power supply must be placed under a roof.

It is recommended to use a ground fault circuit interrupter when connecting the power supply to the wall socket.

The power supply must be mounted on a vertical surface, such as a wall or a fence.

# INSTALLATION

Do not, under any circumstances, mount the power supply at a height where there is a risk it can be submerged in water (at least 30 cm from the ground). It is not permitted to place the power supply on the ground.

Never connect the power supply to a outlet if plug or cord is damaged. Damaged or entangled cord increase the risk of electric shock.

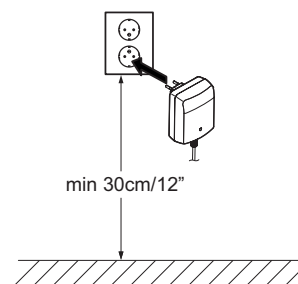

3012-1344

## IMPORTANT INFORMATION

Use the power supply's plug to disconnect the charging station, for instance before cleaning or repairing the loop wire.

## Installing and connecting the charging station

1. Position the charging station in a suitable spot.
2. Tilt the protective cover on the charging station forward and connect the low voltage cable to the charging station.
3. Connect the power supply's power cable to a 100-240 V wall socket.
4. Attach the charging station to the ground using the supplied screws. Ensure the screws are screwed all the way down in the countersink. If the charging station is placed against a wall, it is best to wait before securing the charging station to the ground until after all the wires have been connected.

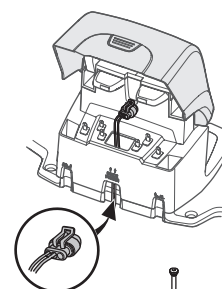
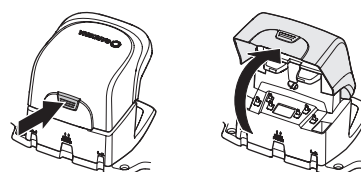

3018-235

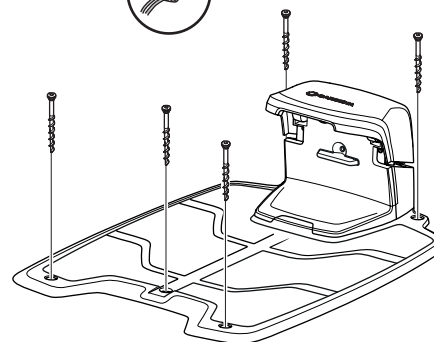

3018-220

## IMPORTANT INFORMATION

It is not permitted to make new holes in the charging station's plate. Only the existing holes may be used to secure the base plate to the ground.

## IMPORTANT INFORMATION

Do not tread or walk on the charging station's plate.



3018-221



---

# INSTALLATION

---

## 3.3 Charging the battery

As soon as the charging station is connected, it is possible to charge the robotic lawnmower. Set the main switch to position 1.

Place the robotic lawnmower in the charging station to charge the battery while the boundary and guide wires are being laid.

If the battery is flat, it takes around 80 to 100 minutes to fully charge it.

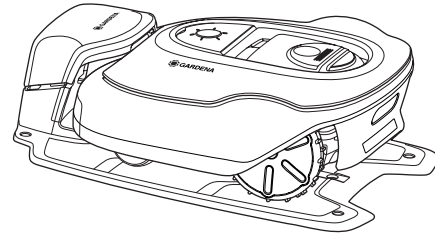

3018-217

### IMPORTANT INFORMATION

**The robotic lawnmower cannot be used before the installation is complete.**



# INSTALLATION

## 3.4 Installation of the boundary wire

Ensure correct installation of the boundary wire according to the instruction

The boundary wire can be installed in one of the following ways:

- Secure the wire to the ground with pegs.

It is preferable to staple down the boundary wire if you want to make adjustments to the boundary loop during the first few weeks of operation. After a few weeks the grass will have grown over the wire making it no longer visible. Use a hammer/plastic mallet and the pegs supplied when carrying out the installation.

- Bury the wire.

It is preferable to bury the boundary wire if you want to dethatch or aerate the lawn. If necessary, both methods can be combined so one part of the boundary wire is pegged down and the remainder is buried. The wire can be buried for instance using an edge cutter or a straight spade. Make sure to lay the boundary wire at least 1 cm and a maximum of 20 cm in the ground.

## Plan where to lay the boundary wire

The boundary wire must be laid so that:

- The wire forms a loop around the working area for the robotic lawnmower. Only original boundary wire must be used. It is specially designed to resist dampness from the soil that could otherwise easily damage the wires.
- The robotic lawnmower is never more than 35 metres from the wire at any point in the entire working area.
- The wire is no more than 800 metres long.
- About 20 cm of extra wire is available to which the guide wire will be connected later. See 3.6 *Installation of the guide wire on page 28*.

Depending on what the working area is adjacent to, the boundary wire must be laid at different distances from obstacles. The illustration below shows how the boundary wire must be laid around the working area and around obstacles. Use the supplied measurement gauge to obtain the correct distance. See 2.1 *What is what? on page 11*.

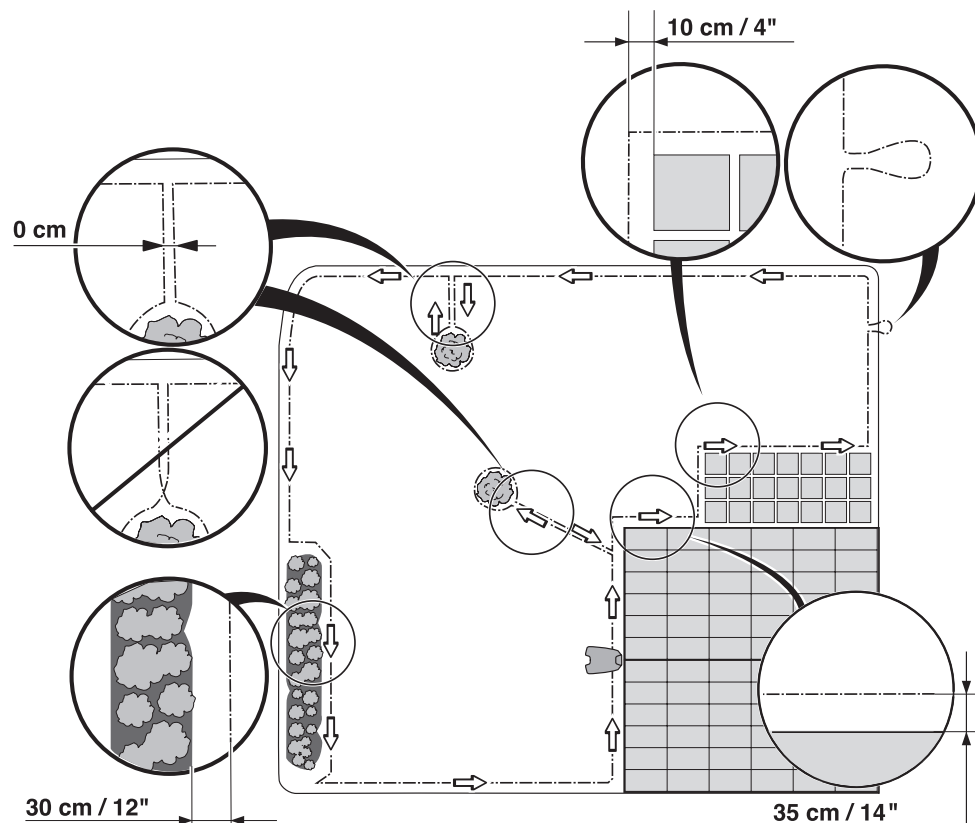

3023-031

English - 21



# INSTALLATION

## Working area boundaries

If a high obstacle (5 cm or more), for example a wall or fence, borders the working area, the boundary wire should be laid 35 cm from the obstacle. This will prevent the robotic lawnmower from colliding with the obstacle and reduce body wear.

About 20 cm of the lawn around the fixed obstacle will not be mown.

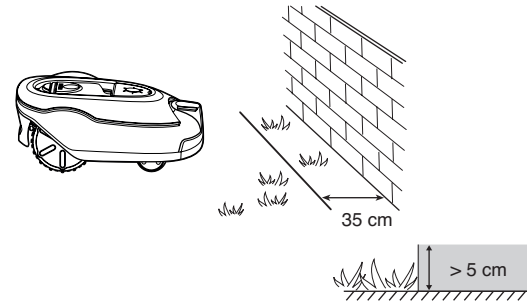

3018-205

If the working area borders on a small ditch, for example a flower bed or a small elevation, for example a low kerbstone (1-5 cm), the boundary wire should be laid 30 cm inside the working area. This prevents the wheels from driving into the ditch or up onto the kerbstone which might lead to excessive wear on the robotic lawnmower, and especially the front wheels.

About 15 cm of the lawn along the ditch/kerbstone will not be mown.

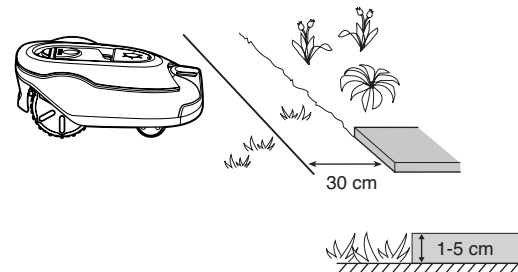

3018-206

If the working area borders on a paving stone path or similar that is level with the lawn (+/- 1 cm), it is possible to allow the robotic lawnmower to run a little over the path. The boundary wire should then be laid 10 cm from the edge of the path.

All the grass along the side of the paving stone path will be cut.

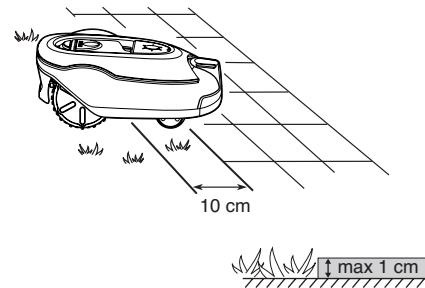

3018-208

When the working area is divided by a paving stone path that is level with the lawn, it is possible to allow the robotic lawnmower to run over the path. It can be an advantage to lay the boundary wire under the paving stones. The boundary wire can also be laid in the joint between the paving stones. Ensure that the tiles are in level with the lawn to avoid excessive wear on the robotic lawnmower.

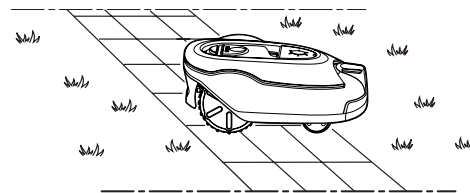

3018-207

**Note:** The robotic lawnmower must never run over gravel, mulch or similar material which can damage the blades.

### IMPORTANT INFORMATION

**If the working area is adjacent to water bodies, slopes, precipices or a public road, the boundary wire must be supplemented with an edging or the like. It must then be at least 15 cm in height. This will prevent the robotic lawnmower from ending up outside the working area under any circumstance.**

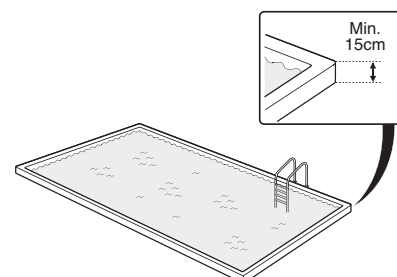

3018-046



# INSTALLATION

## Boundaries within the working area

Use the boundary wire to isolate areas inside the working area by creating islands around obstacles which cannot withstand a collision, for example flowerbeds, bushes and fountains. Lay the wire up to and around the area to be isolated, and then return it back along the same route. If pegs are used, the wire should be laid under the same pegs on the return route. When the boundary wires to and from the island are laid close together, the robotic lawnmower can drive over the wire.

### IMPORTANT INFORMATION

The boundary wire may not be crossed on its way to and from an island.

Obstacles that can withstand a collision, for example, trees or bushes taller than 15 cm, do not need to be isolated with the boundary wire. The robotic lawnmower will turn around when it collides with this type of obstacle.

It is recommended to isolate all fixed objects in and around the working area. This results in the most gentle and silent operation and prevent the robotic lawnmower from getting stuck in the objects under any circumstances.

Obstacles that slope slightly, for example stones or large trees with raised roots, must be isolated or removed. Otherwise the robotic lawnmower can slide up onto this kind of obstacle causing the blades to be damaged.

## Secondary areas

If the working area consists of two areas which the robotic lawnmower has difficulty travelling between, it is recommended to set up a secondary area. Instances of this are 35% slopes or a passage that is narrower than 60 cm. Lay the boundary wire then around the secondary area so that it forms an island outside of the main area.

The robotic lawnmower must be moved manually between the main and secondary area when the lawn in the secondary area has to be cut. The *Secondary area (A)* operating mode must be used as the robotic lawnmower cannot travel on its own from the secondary area to the charging station. See 5.1 *Operation selection Start* on page 40. In this mode, the robotic lawnmower will never look for the charging station but will mow until the battery runs out. When the battery is flat, the robotic lawnmower will stop and the *Needs manual charging* message will appear in the display. Then place the robotic lawnmower in the charging station to charge the battery. If the main area has to be cut straight after charging, the **START** button must be pressed and the *Main area (B)* selected before closing the hatch.

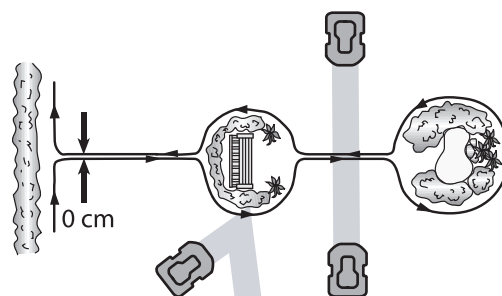

3023-005

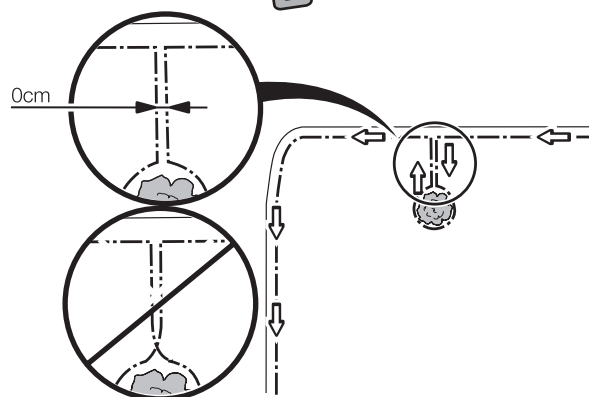

3012-686

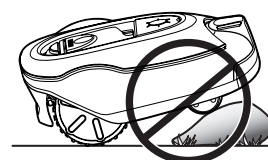

3018-209

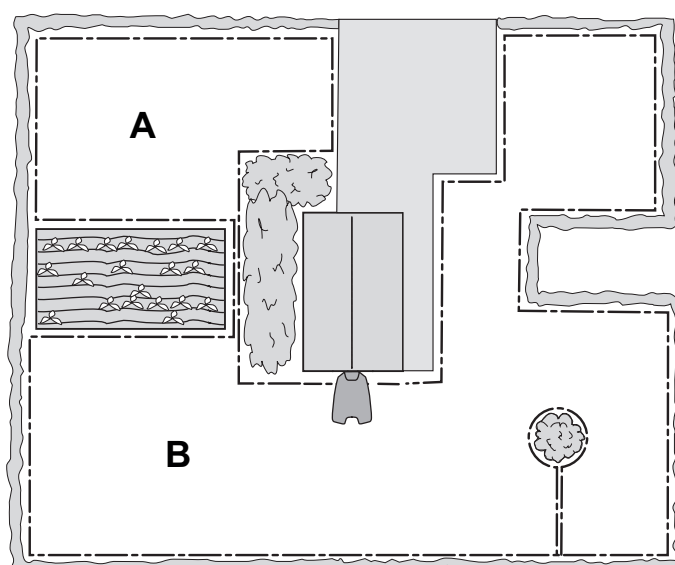

3023-006

# INSTALLATION

## Passages when mowing

Long and narrow passages and areas narrower than 1.5 to 2 metres should be avoided. When the robotic lawnmower mows, there is a risk that it travels around in the passage or area for a long period of time. The lawn will then look flattened.

## Slopes

The robotic lawnmower can also operate on sloping working areas. The maximum gradient is defined as percentage units (%). The slope as a percentage is calculated as the difference in elevation in centimetres for every metre. If for instance the difference in elevation is 10 cm, the slope gradient is 10%. See the illustration.

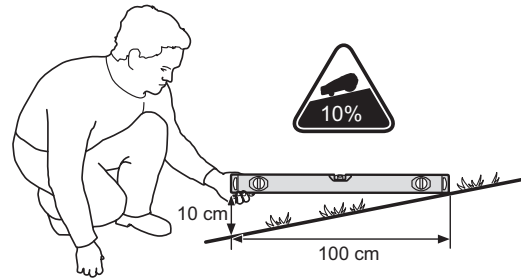

3012-1346

The boundary wire can be laid across a slope that slants less than 15%.

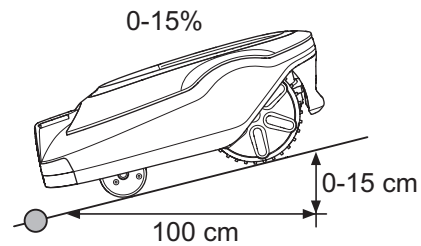

3018-210

The boundary wire should not be laid across a slope that is steeper than 15%. There is a risk that the robotic lawnmower will find it difficult to turn there. The robotic lawnmower will then stop and the *Outside working area* fault message is displayed. The risk is at its greatest in damp weather conditions, as the wheels can slip on the wet grass.

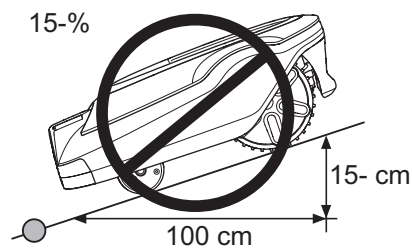

3018-211

However, the boundary wire can be laid across a slope steeper than 15% if there is an obstacle that the robotic lawnmower is allowed to collide with, for example, a fence or a dense hedge.

Inside the working area the robotic lawnmower can mow areas which slope up to 35%. Areas that slope more must be isolated with the boundary wire.

When a part of the working area's outer edge slopes more than 15%, the boundary wire must be laid about 20 cm in on the flat ground before the beginning of the slope.

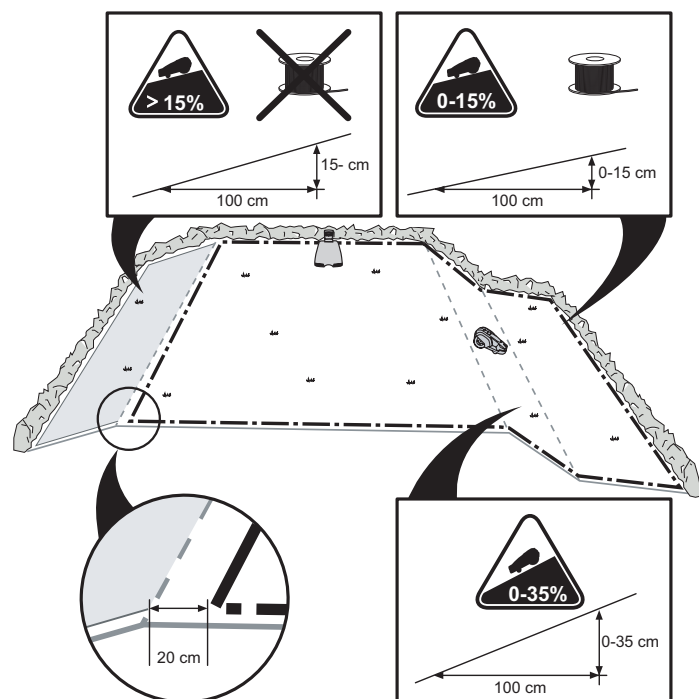

3012-1347

# INSTALLATION

## Laying the boundary wire

If you intend to peg down the boundary wire:

- Cut the grass very low with a standard lawnmower or a trimmer where the wire is to be laid. It will then be easier to lay the wire close to the ground and the risk of the robotic lawnmower cutting the wire or damaging the insulation of the wire is reduced.
- Make sure to lay the boundary wire close to the ground and secure the pegs close together. The cable must lie close to the ground so as not to be cut before the grass roots have grown over it.
- Use a hammer to knock the pegs into the ground. Exercise care when knocking in the pegs and make sure the wire is not under strain. Avoid sharp bends in the wire.

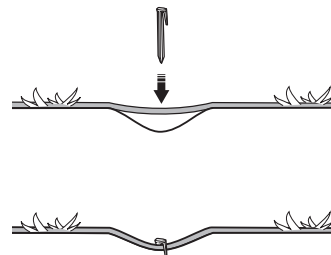

3018-085

If the boundary wire is to be buried:

- Make sure to lay the boundary wire at least 1 cm and a maximum of 20 cm in the ground. The wire can be buried for instance using an edge cutter or a straight spade.

Use the supplied measurement gauge as a guide when you lay out the boundary wire. This helps you to easily set the correct distance between the boundary wire and the boundary/obstacle. The measurement gauge is broken loose from the box.

### IMPORTANT INFORMATION

**Extra wire must not be placed in coils outside the boundary wire. This can disrupt the robotic lawnmower.**

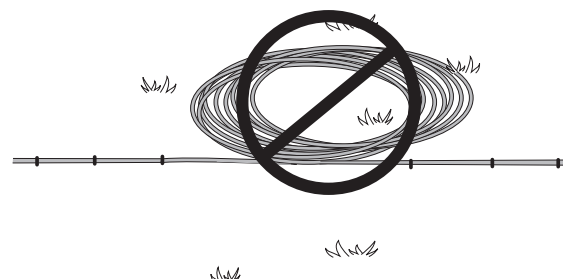

3012-281

## Eyelet for connecting the guide wire

To facilitate the connection of the guide wire to the boundary wire, it is recommended to create an eyelet with about 20 cm of extra boundary wire at the point where the guide wire will later be connected. It is a good idea to plan where the guide wire will be placed before laying out the boundary wire. See 3.6 *Installation of the guide wire on page 28*.

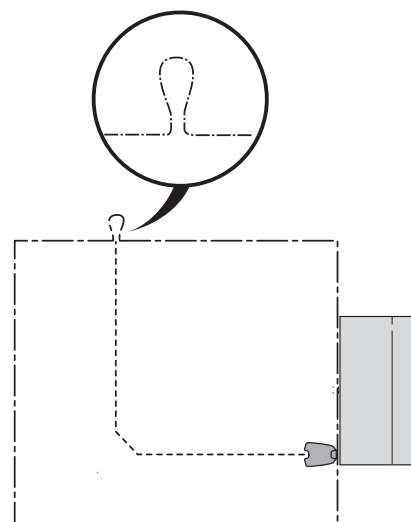

3023-007

English - 25



# INSTALLATION

## Laying the boundary wire in towards the charging station

On its way toward the charging station, the boundary wire can be laid completely outside the charging station (see option 1 in the figure). If there is a need to partly locate the charging station outside the working area, it is also possible to lay the wire under the charging station plate (see option 2 in the figure).

However most of the charging station must not be placed outside the working area as the robotic lawnmower can then find it difficult to find the charging station (see figure).

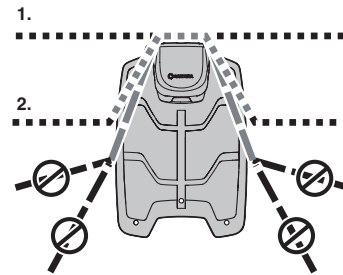

3018-241

## Splicing the boundary wire

Use an original coupler if the boundary wire is not long enough and needs to be spliced. It is waterproof and gives a reliable electrical connection.

Insert both wire ends in the coupler. Check that the wires are fully inserted into the coupler so that the ends are visible through the transparent area on the other side of the coupler. Now press down the button on top of the coupler fully. Use a polygrip to completely press down the button on the coupler.

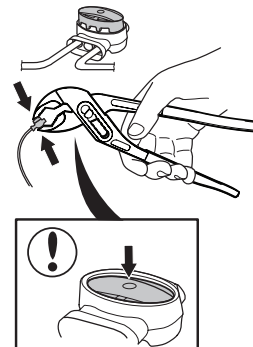

3012-1323

### IMPORTANT INFORMATION

**Twinned cables, or a screw terminal block that is insulated with insulation tape are not satisfactory splices. Soil moisture will cause the wire to oxidise and after a time result in a broken circuit.**



# INSTALLATION

## 3.5 Connecting the boundary wire

Connect the boundary wire to the charging station:

### IMPORTANT INFORMATION

The boundary wire must not be crossed when connecting it to the charging station. The right hand wire end must be connected to the right hand pin on the charging station and the left hand wire end to the left pin.

1. Place the wire ends in the connector:
  - Open the connector.
  - Place the wire in the connector grip.
2. Press the connectors together using a pair of pliers. Press until you hear a click.
3. Cut off any surplus boundary wire. Cut 1-2 cm above each connector.
4. Tilt the protective cover on the charging station forward and run the wire ends up each channel at the rear of the charging station. Press the connector onto the metal pins, marked AL (left) and AR (right), on the charging station.
5. Mark the wires with the accompanying cable markers. This makes it easier to reconnect the wires correctly when for instance the charging station has been stored indoors for the winter.

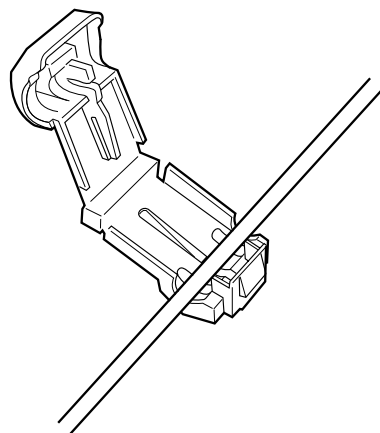

3012-284

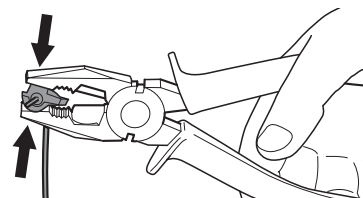

3012-264

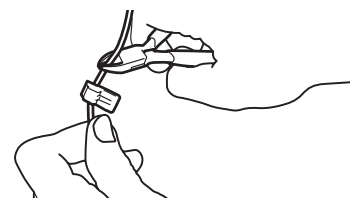

3012-265

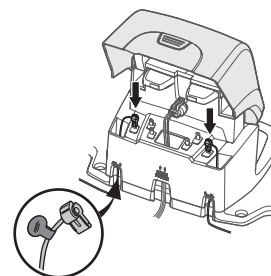

3018-236

### IMPORTANT INFORMATION

The right hand connector must be connected to the right hand metal pin on the charging station and the left hand wire end to the left connector.

# INSTALLATION

## 3.6 Installation of the guide wire

The guide wire is a wire that is laid from the charging station towards, for instance, a remote part of the working area or through a narrow passage to be then connected with the boundary loop. The same cable roll is used for both the boundary loop and guide wire.

The guide wire is used by the robotic lawnmower to find its way back to the charging station but also to guide the robotic lawnmower to hard-to reach areas of the garden.

Run the robotic lawnmower at varying distances from the guide wire to reduce the risk of tracks forming. The area beside the wire which the robotic lawnmower then uses is called the Corridor. The wider the corridor allowed by the installation, the less the risk of tracks forming. When installing, it is therefore important to create as much free space as possible along the guide wire.

The robotic lawnmower always runs to the left of the guide wire as seen facing the charging station. Thus the corridor is to the left of the guide wire. When installing, it is therefore important to create as much free space as possible to the left of the guide wire, as seen facing the charging station. It is not allowed to lay the guide wire closer than 30 cm from the boundary wire.

The guide wire, as the boundary wire, can be pegged on or buried in the ground.

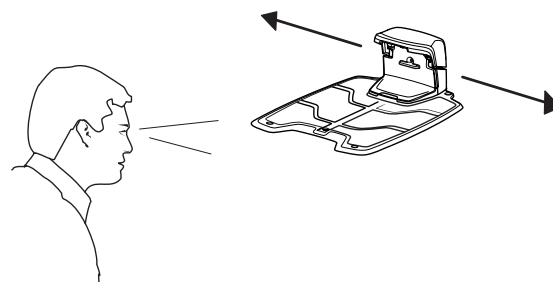
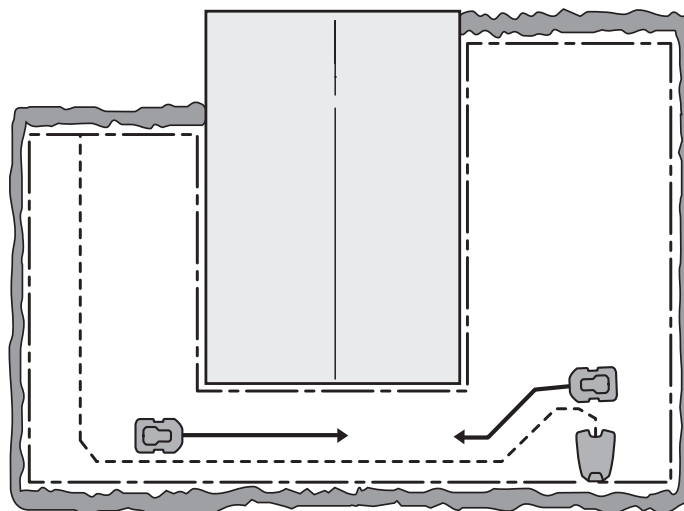

### IMPORTANT INFORMATION

**Make sure to have as much free space as possible to the left of the guide wire, as seen facing the charging station.**

# INSTALLATION

## Laying and connecting the guide wire

1. Before laying and connecting the guide wire, it is important to give consideration to the length of the guide loop, especially in large or complex installations. If the guide loop is longer than 400 metres the robotic lawnmower can have difficulty following the guide wire.

The guide wire together with the section of the boundary loop that makes up the return wire to the charging station is called the guide loop. The current in the guide loop always goes to the left at the connection from the guide wire to the boundary loop. The two figures here display what is regarded as a guide loop. The figures are also a good example of how the guide loop in a working area can have very varying lengths depending on where the charging station is placed.

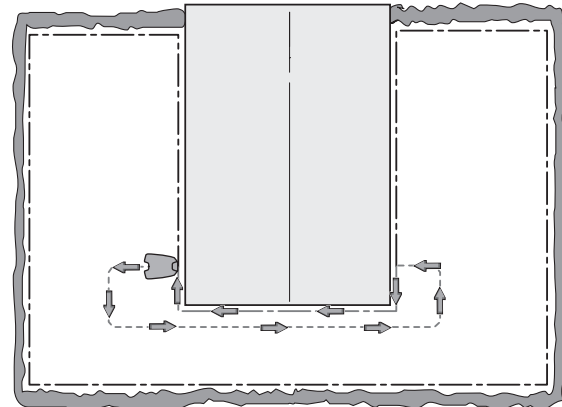

3023-009

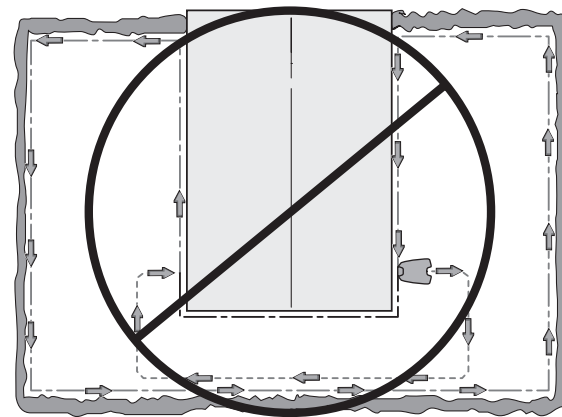

3023-010

2. Tilt the top cover on the charging station forward and run the guide wire through one of two channels marked GUIDE leading to the guide connection.
3. Fit a connector to the guide wire in the same way as for the boundary wire in 3.5 *Connecting the boundary wire on page 27*. Connect it to the contact pin on the charging station that is labelled G1.
4. Mark the wires with the accompanying cable markers. This makes it easier to reconnect the wires correctly when for instance the charging station has been stored indoors for the winter.
5. Run the guide wire straight under the charging plate and then at least 2 metres straight out from the front edge of the plate.

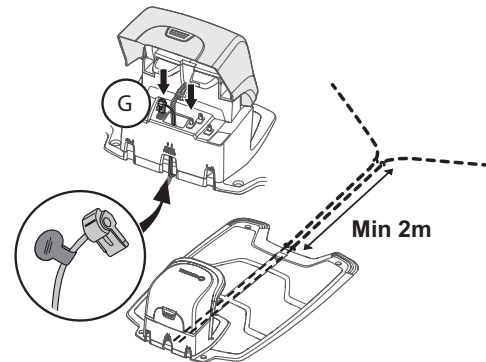

3018-242

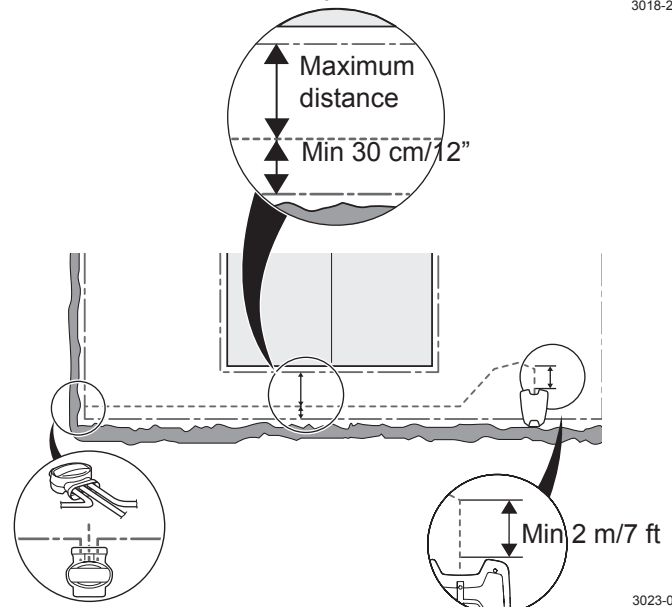

3023-011

English - 29

# INSTALLATION

If the guide wire has to be installed on a steep slope, it is an advantage to lay the wire at an angle to the slope. This makes it easier for the robotic lawnmower to follow the guide wire on the slope.

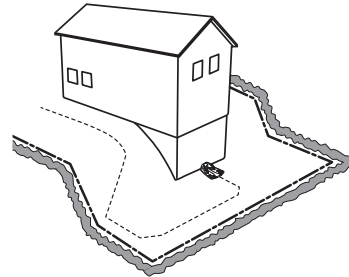

3018-061

Avoid laying the wire at sharp angles. This can make it difficult for the robotic lawnmower to follow the guide wire.

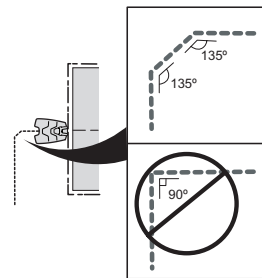

3012-1327

6. Run the guide wire to the point on the boundary loop where the guide wire is to be connected.

Lift up the boundary wire. Cut the boundary wire using for instance a pair of wire cutters. Connecting the guide wire is made easier if an eyelet has been made on the boundary wire as outlined in the previous description. See *Eyelet for connecting the guide wire* on page 25.

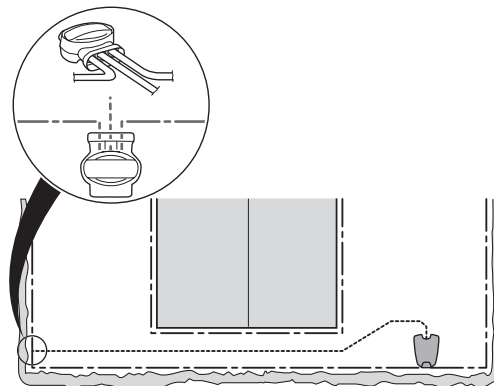

3023-015

7. Connect the guide wire to the boundary wire using a coupler:

Insert the boundary wire and guide wire in the coupler. Check that the wires are fully inserted into the coupler so that the ends are visible through the transparent area on the other side of the coupler.

Use a polygrip to completely compress the button on the coupler.

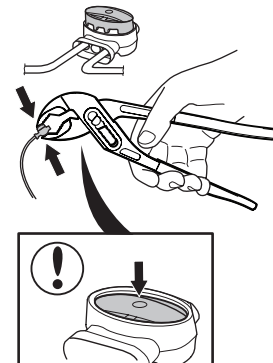

3018-1323

It does not matter which holes are used to connect each wire.

8. Staple down/bury the splice in the lawn.

## IMPORTANT INFORMATION

The guide wire may not cross the boundary wire, for instance a boundary wire that is laid out to an island.

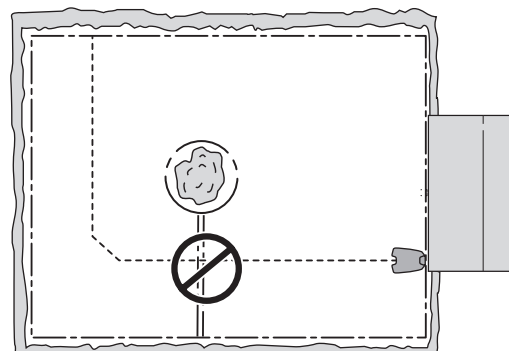

3023-016

# INSTALLATION

## 3.7 Checking the installation

Check the loop signal by inspecting the indicator lamp on the charging station.

- Solid green light = good signals.
- Flashing green light = the loop system is turned off and the robotic lawnmower is in ECO mode. See 6.8 *Settings on page 56*.
- Flashing blue light = interruption in the boundary loop, no signal.
- Flashing red light = interruption in the charging station's antenna plate. The fault should be rectified by an authorized service technician.
- Solid blue light = weak signal. This may depend on the boundary loop being too long or that the wire is damaged. If the robotic lawnmower still works, this is not a problem.
- Solid red light = fault in the circuit board in the charging station. The fault should be rectified by an authorized service technician.

See 9.3 *Indicator lamp in the charging station on page 73* if the lamp does not indicate a solid or flashing green light.

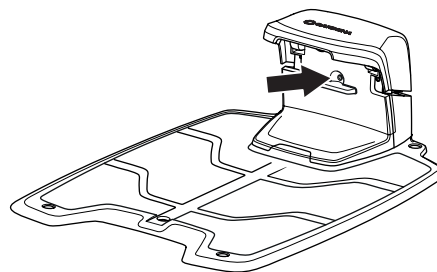

3018-216

# INSTALLATION

## 3.8 First start-up and calibration

Before the robotic lawnmower is operated, a start-up sequence in the robotic lawnmower's menu must be carried out as well as an automatic calibration of the guide signal.

1. Open the control panel hatch by pressing the **STOP** button.
2. Set the main switch to position 1.

A start-up sequence begins when the robotic lawnmower is started for the first time. The following is requested:

- Language.
- Country.
- Date.
- Time.
- Selection and confirmation of personal PIN code. All combinations except 0000 are permitted.

Place the robotic lawnmower in the charging station and press **START**.

The robotic lawnmower will now begin to calibrate the guide wire. Press **START** and close the hatch. The calibration is performed by the robotic lawnmower backing out of the charging station and running a calibration process in front of the charging station. When this is completed, mowing can begin.

### IMPORTANT INFORMATION

Use Memo on page 2 to make a note of the PIN code.

## 3.9 Test docking with the charging station

Before using the robotic lawnmower, check that the robotic lawnmower can follow the guide wire all the way to the charging station and easily docks with the charging station. Perform the test below.

1. Open the control panel cover by pressing the **STOP** button.
2. Place the robotic lawnmower close to the point where the guide wire is connected to the boundary wire. Place the robotic lawnmower about 2 metres from the guide wire, facing the guide wire.
3. Press the **PARK** button and close the cover.



---

## INSTALLATION

---

4. Check that the robotic lawnmower follows the guide wire all the way to the charging station and that it docks with the charging station. The test is approved only if the robotic lawnmower is able to follow the guide wire the entire distance to the charging station and docks at the first attempt. If the robotic lawnmower is unable to dock on the first attempt, it will automatically try again. The installation is not approved if the robotic lawnmower needs two or more attempts to dock with the charging station. In this case, check that the charging station, the boundary wire and the guide wire are installed in accordance with the instructions.
5. The robotic lawnmower will stay in the charging station until you press the **START** button.

The guide system must first be calibrated if the above test is to provide a satisfactory result. See 3.8 *First start-up and calibration* on page 32.

## 4 Use

### 4.1 Charging a flat battery

When the GARDENA robotic lawnmower is new or has been stored for a long period, the battery will be flat and needs to be charged before starting.

1. Set the main switch to position 1.
2. Place the robotic lawnmower in the charging station. Open the cover and slide the robotic lawnmower in as far as possible to ensure proper contact between the robotic lawnmower and the charging station.
3. The display shows a message that charging is in progress.

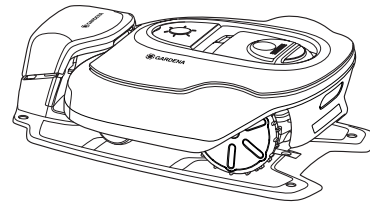

3018-217

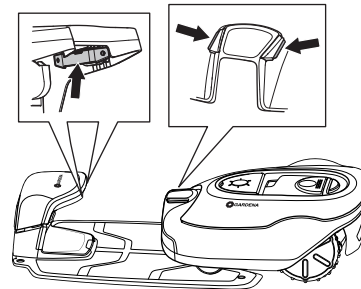

3018-222



**WARNING**

Read the safety regulations before you start your robotic lawnmower.

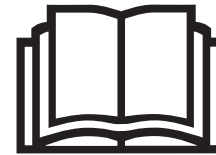

1001-003



**WARNING**

Keep your hands and feet away from the rotating blades. Never put your hands or feet close to or under the body when the motor is running.



3012-663



**WARNING**

Never use the robotic lawnmower when persons, especially children, or pets, are in the cutting area.

# USE

## 4.2 Using the timer

The lawn should not be cut too often to obtain the best mowing result. Use the timer function (see 6.3 *Timer on page 44*) to avoid a downtrodden lawn and to get the maximum service life from the robotic lawnmower. When setting the timer, calculate that the robotic lawnmower mows about the number of square meters per hour and day listed below:

Work capacity			
	R100Li, R100LiC	R130Li, R130LiC	R160Li
<b>m<sup>2</sup> per hour and day</b>	59	68	70

For example; If the working area is 800 m<sup>2</sup> the robotic lawnmower must operate for about:

	R100Li, R100LiC	R130Li, R130LiC	R160Li
<b>Hours per day</b>	14	12	11

The times are approximate and depends for instance on grass quality, blade sharpness and battery age.

### IMPORTANT INFORMATION

**Use the timer to avoid mowing when there are usually children, pets and anything else about that could be hurt or damaged by the rotating blades on the lawn.**

The factory setting is that the robotic lawnmower will operate around the clock seven days a week.

If the size of the working area allows it, the quality of the grass can be further improved if it is cut every other day instead of a few hours every day. In addition, the grass benefits from resting completely during at least a three-day period once a month.

The maximum capacity is only obtained when the robotic lawnmower is allowed to mow around the clock seven days a week.

	R100Li, R100LiC	R130Li, R130LiC	R160Li
<b>Maximum capacity, m<sup>2</sup></b>	1000	1300	1600

# USE

## 4.3 Standby

The robotic lawnmower has a built-in standby period according to the Standby time table. The standby period provides a good opportunity to e.g. water or play games on the lawn.

	R100Li, R100LiC	R130Li, R130LiC	R160Li
Standby time, hours per day <sup>2</sup>	7	5	1

### Example 1

The times used in this example are applicable to GARDENA R130Li and R130LiC, but the principle is the same for the other models.

Work period 1: 00:00 - 19:00.

Work days: All days.

The factory setting ensures that the robotic lawnmower begins cutting the lawn at 00.00. The mower is parked in the charging station from 19.00 and rests until it starts cutting again at 00.00.

If the timer setting is divided into two work periods, the standby period can be divided into a number of periods. The total standby time must however be at least 5 hours.

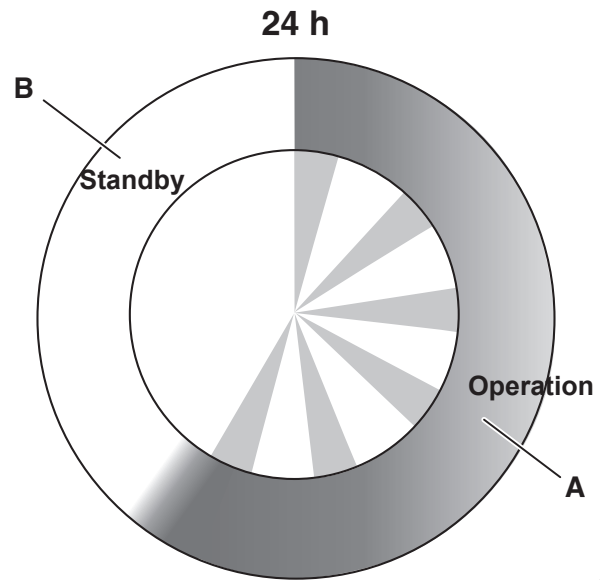

3018-245

GARDENA R130Li, R130LiC	
Operation	A = Max 19 h
Charging/Standby	B = Min 5 h

### Example 2

The times used in this example are applicable to GARDENA R130Li and R130LiC, but the principle is the same for the other models.

Work period 1: 08:00 - 16:00.

Work period 2: 20:00 - 23:00.

Work days: All days.

The robotic lawnmower will operate for the times specified in the work periods as the total operating time is 11 hours and does not exceed the maximum of 19 hours.

Max. operating time	19 h
Min. standby time	5 h
Area/hour/day	68 m <sup>2</sup>

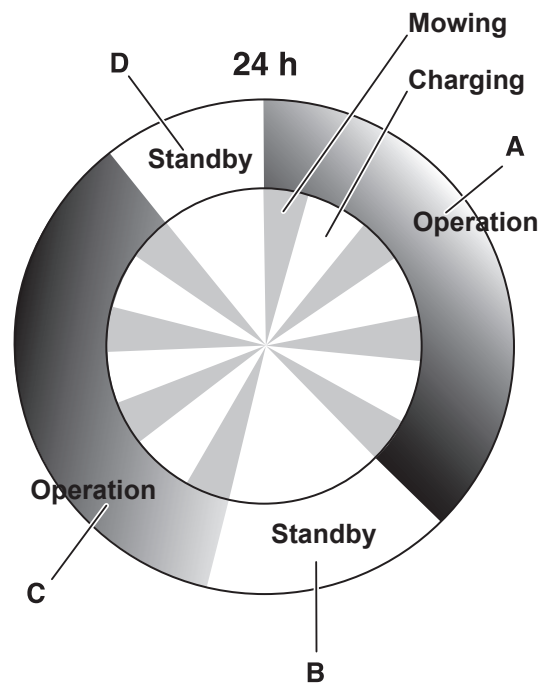

3018-246

GARDENA R130Li, R130LiC	
Operation	A + C = Max 19 h
Charging/Standby	B + D = Min 5 h

# USE

## 4.4 Starting

1. Press the **STOP** button to open the control panel hatch.
2. Set the main switch to position *1*.
3. Enter the PIN code.

4. Push the **START** button.
5. Make the required operation selection. See 5.1 *Operation selection Start on page 40*.
6. Shut the hatch within 10 seconds.

If the robotic lawnmower is parked in the charging station, it will only leave the charging station when the battery is fully charged and if the timer is set to allow the mower to operate.

Before the blade disc starts a warning beep can be heard consisting of 5 short beeps for 2 seconds.

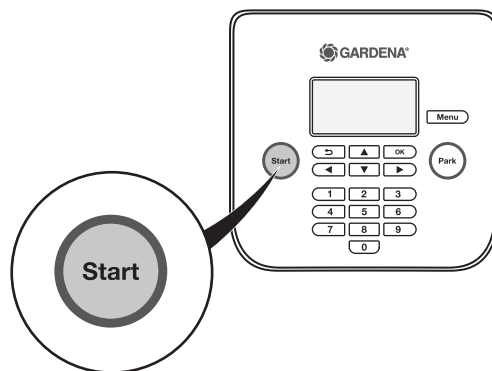

3018-240

## 4.5 Stopping

1. Press the **STOP** button.

The robotic lawnmower stops, the blade motor stops and the control panel hatch opens.

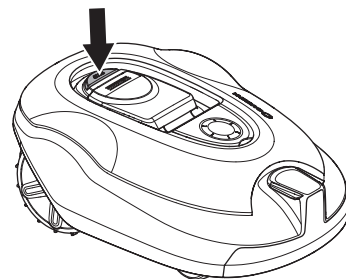

## 4.6 Switching off

1. Press the **STOP** button.
2. Set the main switch to position *0*.

Always switch the robotic lawnmower off using the main switch if it requires maintenance or if the robotic lawnmower must be moved outside the working area.

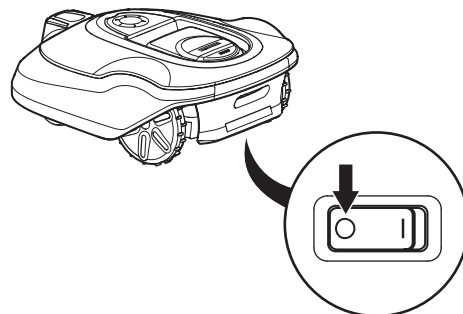

3018-202

3018-213

# USE

## 4.7 Adjusting the cutting height

The cutting height can be varied from MIN (2 cm) to MAX (6 cm) in nine stages.

During the first week after a new installation, the cutting height must be set to MAX to avoid damaging the loop wire. After this, the cutting height can be lowered one step every week until the desired cutting height has been reached.

If the grass is long, allow the robotic lawnmower to start mowing at the MAX cutting height. Once the grass is shorter, you can gradually lower the cutting height.

To adjust the cutting height:

1. Press the **STOP** button to stop the robotic lawnmower
2. Open the cutting height adjustment hatch.
3. Turn the knob to the required position. The selected position is the marking on the body that aligns with the arrow on the knob. Turn clockwise to increase the cutting height. Turn counter-clockwise to decrease the cutting height.
4. Close the hatch.

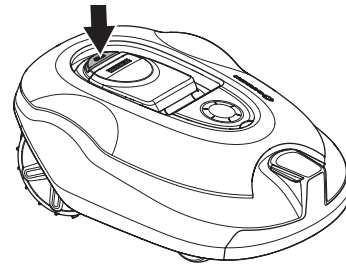

3018-202

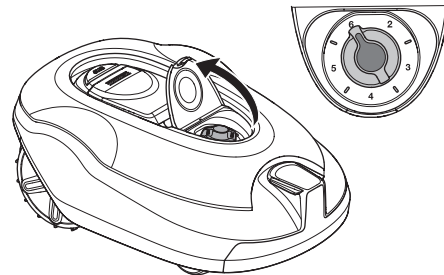

3018-223

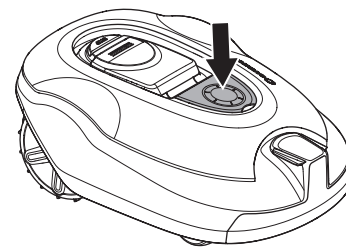

3018-214

### IMPORTANT INFORMATION

During the first week after a new installation, the cutting height must be set to MAX to avoid damaging the loop wire. After this, the cutting height can be lowered one step every week until the desired cutting height has been reached.

# CONTROL PANEL

## 5 Control panel

All forms of commands and settings for the robotic lawnmower are made via the control panel. All functions are accessed via a number of menus.

The control panel consists of a display and a keypad. All information is shown on the display and all input is done using the buttons.

When the stop button has been pressed and the hatch is opened, the start page is displayed showing the following information:

- Operating information, e.g. *MOWING*, *PARKED* or *TIMER*. If the stop button is pressed when the robotic lawnmower is running, what it did just before it was stopped e.g. *MOWING* or *SEARCHING* is displayed. The text *READY* is displayed if the robotic lawnmower is not in any specific operating mode, e.g. if the main switch has just been turned on.
- Date and clock show the current time.
- The ECO symbol is displayed if the robotic lawnmower is set in ECO mode.
- The black clock symbol (A) indicates when the mower is not allowed to mow due to a timer setting. If the mower is not allowed to mow due to *SensorControl*, symbol (B) is shown (not applicable for GARDENA R100Li,R100LiC). If the operation mode *Override timer* is chosen, symbol (C) is shown.
- The battery status shows the remaining battery charge. If the robotic lawnmower is loading, a flash is also shown over the battery symbol (D). If the robotic lawnmower is placed in the charging station without charging, (E) is shown.
- The number of operating hours indicates the number of hours since the day of manufacture that the robotic lawnmower has been in operation. The time that the robotic lawnmower has spent mowing or searching for the charging station is counted as operating time.

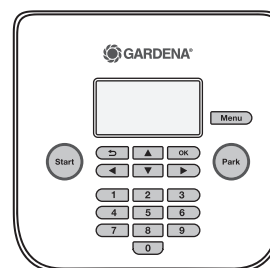

3018-239



3018-306



3012-1379

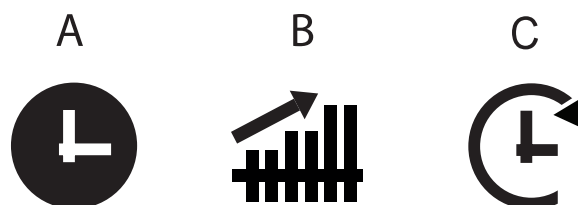

3018-305

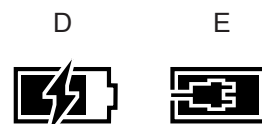

3012-569

# CONTROL PANEL

The keypad consists of six groups of buttons:

- The **START** button is used to activate the robotic lawnmower. This is normally the last button to be pressed before closing the display hatch.
- The **Back** and **OK** buttons are used to navigate in the menu. The **OK** button is also used to confirm settings in the menu.
- The arrow keys are used to navigate in the menu but also to make selections in certain setting options.
- The **MENU** button is used to go to the main menu.
- The **PARK** button is used to send the robotic lawnmower to the charging station.
- Numbers are used to enter settings, for example, PIN code, time or exit direction. They can also be used to enter a number series for shortcuts to the various menus. See 6.1 Main menu on page 42.

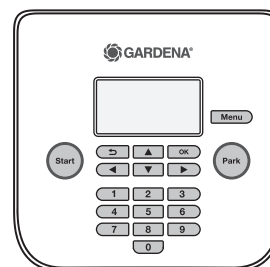

3018-239

## 5.1 Operation selection Start

When the **START** button has been pressed the following operation selections can be selected.

### Main area

The standard, automatic operating mode where the robotic lawnmower mows and charges continually.

### Secondary area

The *Secondary area* operating mode is used when mowing secondary areas where the robotic lawnmower cannot travel to the charging station automatically. For information about secondary areas, see 3.4 *Installation of the boundary wire on page 21*.

Selecting *Secondary area* will cause the robotic lawnmower to mow until the battery is empty.

If the robotic lawnmower charges in the *Secondary area* mode, it will fully charge, drive out about 50 cm and then stop. This indicates that it is charged and ready to start mowing.

If the main working area has to be cut after charging, it is appropriate to switch the operation selection to *Main area* before placing the robotic lawnmower in the charging station.

### Override timer

Any timer settings made can be temporarily overridden by selecting *Override timer*. It is possible to override the timer for 24 h or 3 days.

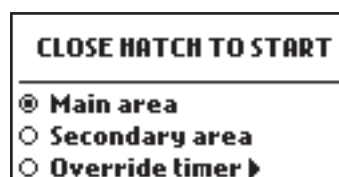

3018-301



---

## CONTROL PANEL

---

### 5.2 Operation selection Parking

When the **PARK** button is pressed the following operation selections can be chosen.

#### Park until further notice

The robotic lawnmower stays in the charging station until another operating mode is selected by pressing the **START** button.

#### Start with next timer

The robotic lawnmower stays in the charging station until the next Timer setting permits operation. This operation selection is suitable if one wishes to cancel an ongoing mowing cycle and allow the robotic lawnmower to stay in the charging station until the next day.

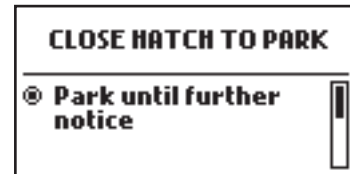

3018-300

### 5.3 Main switch

Set the main switch in the **1** position to start the robotic lawnmower.

Set the main switch in the **0** position when the robotic lawnmower is not in use or work is being carried out on the blade disc.

When the main switch is set in the **0** position the motors on the robotic lawnmower cannot start.

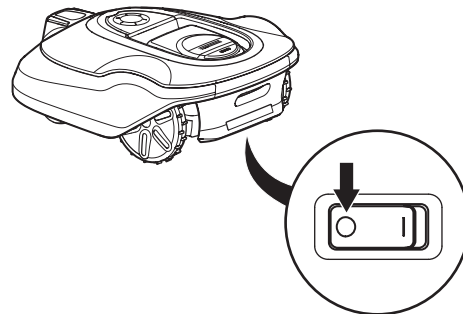

3018-213



# MENU FUNCTIONS

## 6 Menu functions

### 6.1 Main menu

The main menu consists of the following options:

- *Timer*
- *SensorControl* (only for GARDENA R130Li, R130LiC, R160Li)
- *SmartSystem* (only for GARDENA R100LiC, R130LiC)
- *Security*
- *Installation*
- *Settings*

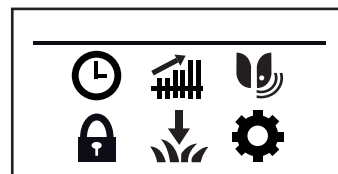

3018-303

There are a number of submenus under each option. You can access all the functions to set the robotic lawnmower settings via these.

### Browse between menus

Browse through the main menu and submenus with the help of the arrow keys. Enter values and times using the number keys and confirm each selection with the multi-choice button marked **OK**.

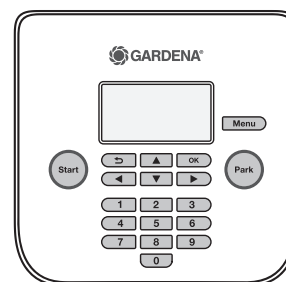

3018-239

### Submenus

Certain submenus contain a box that can be checked. This is used to select which option(s) is/are selected or if a function is activated/deactivated. Check or uncheck the box by pressing **OK**.

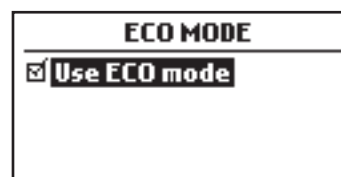







3018-307

## MENU FUNCTIONS

### 6.2 Menu structure

The following table summarises the menu selections found in the main menu. The following chapter provides more detailed information about how each function is used and which setting options are available.

Use the arrow keys to browse the menu. Confirm selections with **OK**.

	<p><i>Timer</i></p> <p>The lawn should not be cut too often to obtain the best mowing result. Consequently, it is important to limit the operating time using the timer function if the working area is less than the robotic lawnmower's working capacity. The timer function is also an ideal tool to control which periods the robotic lawnmower should not mow, for example, when the children are playing in the garden.</p>
	<p><i>SensorControl</i></p> <p>Only for GARDENA R130Li, R130LiC, R160Li.</p> <p>This function allows the robotic lawnmower to automatically adjust its mowing times based on how quick the lawn grows. When the weather is good for grass growth, the robotic lawnmower mows more often and when grass growth is slower the robotic lawnmower will automatically spend less time on the lawn.</p>
	<p><i>Smart System</i></p> <p>Only for GARDENA R100LiC, R130LiC</p> <p>GARDENA Smart System enables wireless interaction between the Mower and other devices in GARDENA Smart System, such as Water Controls and Sensors. From this menu you can include or exclude your robotic mower, and check your wireless connection status to Smart System.</p>
	<p><i>Security</i></p> <p>In this menu, settings relating to security and the connection between the robotic lawnmower and the charging station can be made.</p> <p>There are three security levels to choose from but it is also possible to define your own combination of security functions.</p>
	<p><i>Installation</i></p> <p>This menu function is used to steer the robotic lawnmower to remote parts of a working area. For many working areas there is no need to alter the factory settings, but depending on the lawn complexity the mowing result can be improved by making manual settings.</p>
	<p><i>Settings</i></p> <p>This selection allows you to make changes to the general robotic lawnmower settings such as date and time.</p>

# MENU FUNCTIONS

## 6.3 Timer

The lawn should not be cut too often to obtain the best mowing result. Consequently, it is important to limit the operating time using the timer function if the working area is less than the mower's working capacity. When the robotic lawnmower is allowed to mow too often, the lawn may appear flattened and the robotic lawnmower is subjected to unnecessary wear.

The timer function is also an ideal tool to control which periods the robotic lawnmower should not mow, for example, when the children are playing in the garden.

Maximum performance is obtained when the timer is turned off and the robotic lawnmower is allowed to mow around the clock seven days a week. The operating hours and days are graphically displayed on the robotic lawnmower's display. Active mowing per day is illustrated by a black bar. The rest of the time, the robotic lawnmower is parked in the charging station.

The factory setting is that the timer is inactive and the robotic lawnmower will operate around the clock seven days a week. This is normally a suitable setting for a working area corresponding to the maximum performance:

	R100Li, R100LiC	R130Li, R130LiC	R160Li
<b>Maximum capacity, m<sup>2</sup></b>	1000	1300	1600

When setting the timer, calculate that the robotic lawnmower mows about the number of square meters per hour and day listed in table *Work capacity* See 4.2 *Using the timer on page 35*.

The following tables provides suggestions for different timer settings depending on garden size. The table can be used to set the operating time. The times should be seen as indicative, they may need to be adjusted to suit the garden. Use the table as follows:

- Find a work area that closest matches the garden's area.
- Select an appropriate amount of work days (for some work areas 7 days may be needed).
- Work hours per day shows how many hours a day the robotic lawnmower will be allowed to work for the selected amount of work days.
- Suggested time interval shows a time interval that corresponds to the required work hours per day.

It is possible to configure two work periods a day. There can be unique work periods in each day, but it is also possible to copy the current day's work period to all the other days.

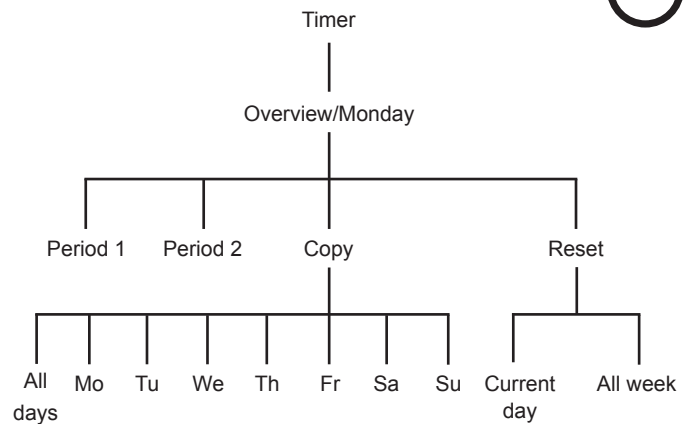

3018-309

## MENU FUNCTIONS

<b>GARDENA R100Li, R100LiC</b>			
<b>Work area</b>	<b>Work days per week</b>	<b>Work hours per day</b>	<b>Suggestion of time interval</b>
250 m <sup>2</sup>	5	6 hours	07:00 - 13:00
	7	4,5 hours	07:00 - 11:30
500 m <sup>2</sup>	5	12 hours	07:00 - 19:00
	7	8,5 hours	07:00 - 15:30
750 m <sup>2</sup>	5	17 hours	07:00 - 24:00
	7	13 hours	07:00 - 20:00
1000 m <sup>2</sup>	7	17 hours	07:00 - 24:00

<b>GARDENA R130Li, R130LiC</b>			
<b>Work area</b>	<b>Work days per week</b>	<b>Work hours per day</b>	<b>Suggestion of time interval</b>
250 m <sup>2</sup>	5	5,5 hours	07:00 - 12:30
	7	4 hours	07:00 - 11:00
500 m <sup>2</sup>	5	10,5 hours	07:00 - 17:30
	7	7,5 hours	07:00 - 14:30
750 m <sup>2</sup>	5	15,5 hours	07:00 - 22:30
	7	11 hours	07:00 - 18:00
1000 m <sup>2</sup>	7	15 hours	07:00 - 22:00
1300 m <sup>2</sup>	7	19 hours	05:00 - 24:00

<b>GARDENA R160Li</b>			
<b>Work area</b>	<b>Work days per week</b>	<b>Work hours per day</b>	<b>Suggestion of time interval</b>
250 m <sup>2</sup>	5	5 hours	07:00 - 12:00
	7	3,5 hours	07:00 - 10:30
500 m <sup>2</sup>	5	10 hours	07:00 - 17:00
	7	7 hours	07:00 - 14:00
750 m <sup>2</sup>	5	15 hours	07:00 - 22:00
	7	11 hours	07:00 - 18:00
1000 m <sup>2</sup>	5	20 hours	04:00 - 24:00
	7	14,5 hours	07:00 - 21:30
1250 m <sup>2</sup>	7	18 hours	06:00 - 24:00
1600 m <sup>2</sup>	7	23 hours	01:00 - 24:00

# MENU FUNCTIONS

## Edit day

To edit the timer settings, first select the day to edit from the *Overview* screen using the arrow left and arrow right followed by **OK**.

Up to two time intervals per day can be entered. To enter an interval for Period 1, first make sure that the check box next to Period 1 is checked. To check/uncheck select the check box and press **OK**. Enter the desired times using the numeric keypad.

If two intervals are desired, first check the check box next to Period 2 then enter times as above. Two intervals can be useful for enabling the lawn for other activities during certain hours, for example by entering Period 1: 00:00-15:00 and Period 2: 21:00-24:00. The mower will then be parked in the charging station between 15:00 and 21:00.

To disable mowing during the whole day, uncheck both periods.



3018-320

## Copy

Use this function to copy the current day settings to other days.

Use the up and down arrow keys to move the cursor between days. The times will be copied to the days that are marked with OK.

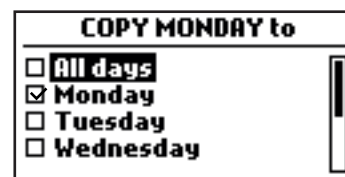

3018-310

## Reset

This function resets the timer to the factory setting, where the robotic lawnmower is allowed to operate 24 hours a day every day.

### Current day

This resets the day that is selected in the tab system.

The factory setting is that the robotic lawnmower is allowed to operate 24 hours a day.



3018-311

### All week

This resets all days in the week.

The factory setting is that the robotic lawnmower is allowed to operate 24 hours a day every day.

# MENU FUNCTIONS

## 6.4 Security

Through this selection, settings relating to security and the connection between the robotic lawnmower and the charging station can be made.



### Security level

There are three security levels to choose from. Use the down and up arrow keys to select a security level.

Low and medium security prohibits access to the robotic lawnmower if the PIN code is unknown. High security also includes a warning that beeps if the correct PIN code is not entered after a designated time period.

If the wrong PIN code is entered 5 times in succession the robotic lawnmower is blocked for a time. The blockage time is extended for every new incorrect attempt.

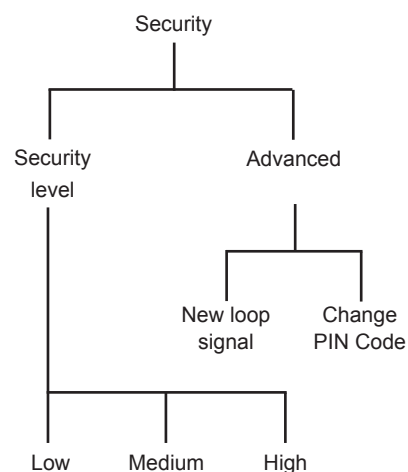

Function	Low	Medium	High
Time lock	X	X	X
PIN request		X	X
Alarm			X

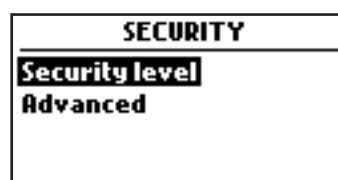

### Time lock

This function means that the robotic lawnmower cannot be started after 30 days without first entering the correct PIN code. When the 30 days has passed the robotic lawnmower will continue to mow as normal, but the *Enter PIN code* message appears when the hatch is opened. Enter your code again and press **OK**.

After this, the selected PIN code must be entered every time the main switch is set to 1.

### PIN request

This function means that the robotic lawnmower requests a PIN code each time the hatch is opened. The correct PIN code must be entered to use the robotic lawnmower.

### Alarm

This function means that an alarm sounds if the PIN code is not entered within 10 seconds after the **STOP** button has been pressed or the robotic lawnmower has been lifted up for any reason. A ticking noise indicates that the PIN code must be entered to prevent triggering the alarm. The alarm can be turned off at any time by entering the correct PIN code.

3018-312

# MENU FUNCTIONS

## Advanced

### New loop signal

The loop signal is randomly selected to create a unique link between the robotic lawnmower in question and the charging station. In rare cases, there may be a need to generate a new signal, for instance if two adjacent installations have a very similar signal.

1. Place the robotic lawnmower in the charging station to which the robotic lawnmower is to be connected.
2. Select *New loop signal* in the menu and press OK.

Press **OK** and await confirmation that the loop signal has been generated. This normally takes about 10 seconds.

### Change PIN code

Enter the new PIN code and press **OK**. Confirm by entering the same code again and pressing **OK**. When the PIN code is changed, the message *PIN code changed* appears in the display momentarily.

Make a note of the new PIN code on the designated line in *Memo* on page 2.

## 6.5 SensorControl

Only applicable for GARDENA R130Li, R130LiC and R160Li.

This function allows the robotic lawnmower to automatically adjust its mowing times based on how quick the lawn grows. When the weather is good for grass growth, the robotic lawnmower mows more often and when grass growth is slower the robotic lawnmower will automatically spend less time on the lawn.

The robotic lawnmower will however not operate longer than the time that may be configured in the timer settings. For optimal SensorControl performance, it is recommended when setting the timer to only de-select the times when the robotic lawnmower must not operate. Other times should be made available for the SensorControl.

When the SensorControl is activated, the robotic lawnmower needs time to decide what the optimal mowing time is for the working area in question. For this reason it can take a number of days before the mowing results are optimal.

When the SensorControl is activated, it is very important to regularly check that the blade disc is clean and that the blades are in good condition. Any grass twisted around the blade disc shaft or blunt blades can affect how the SensorControl functions.

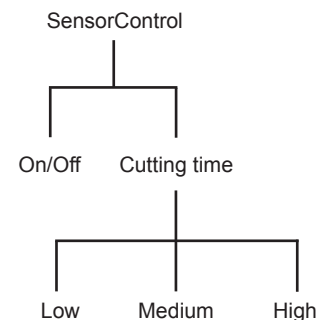
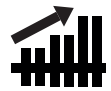

## MENU FUNCTIONS

### SensorControl

To activate the SensorControl: check the box by pressing OK.



3018-308

### Cutting time

If the mowing results are not optimal when using the SensorControl, Cutting time settings may need adjusting.

To adjust the Cutting time: place the cursor by Cutting time and use the right and left arrow keys to increase or decrease the cutting time in three preset intervals.

The longer cutting time that is chosen, the longer the robotic lawnmower will be allowed to work.

## 6.6 Smart System

Only applicable for GARDENA R100LiC, R130LiC

GARDENA Smart System enables wireless interaction between the Mower and other devices in GARDENA Smart System, such as Water Controls and Sensors. In this menu you can include and exclude devices, and check your wireless connection status to Smart System

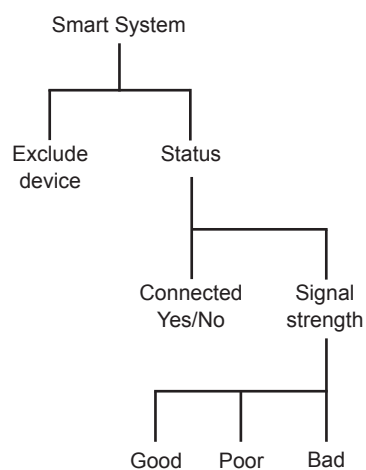

### Get started with GARDENA Smart System

Read the GARDENA Smart System quick guide on how to install the complete system. For installation in short, see below.

1. Download the Smart System application from App Store and/or Google play.
2. Create a personal account in the downloaded application.
3. Power up the Smart System Gateway and connect it to Internet.
4. In the application you can select and add devices. Start with adding the Gateway.
5. After adding the Gateway, select and add the Mower. The gateway is now searching for devices.
6. If you agree to activate the Inclusion mode in the robotic mower display, the mower will now show up in the application.
7. Verify the two inclusion codes from mower and application are identical. If so, select the corresponding mower in the application.

#### IMPORTANT INFORMATION

**The inclusion sequence might take several minutes. Once the inclusion has succeeded you will automatically return to the mower start screen. If the inclusion by any reason fails, try again.**



---

## MENU FUNCTIONS

---

As long as the robotic mower is being included to Smart System some of the menus in the mower display will be locked, so as not to interfere with settings made from the Smart System application. It is still possible to see all settings, but not to adjust them other than from the application. The following settings will be locked in the mower menu:

- Timer
- Time & Date
- Language
- Country

### Exclude device

To remove the wireless connection between the robotic mower and Smart System, select the Exclude device option in the mower menu. If you agree to exclude the device, there will be no more communication between the robotic mower and other Smart System devices. **NOTE!** The robotic mower must be manually deleted from the list of products in the Smart System application.

### Status

As soon as the robotic mower is connected to Smart System Gateway, you can check the connection status from this menu. The status is either connected or not connected. The signal quality between the robotic mower and the Gateway can be either Good, Poor or Bad. The robotic mower charging station should preferably be placed on a garden location with Good signal strengths, for best Smart System performance.





# MENU FUNCTIONS

## 6.7 Installation

This menu function is used to steer the robotic lawnmower to remote parts of a working area. For many working areas there is no need to alter the factory settings but sometimes, depending on the lawn complexity, the mowing result can be improved by making manual settings.



### Lawn coverage

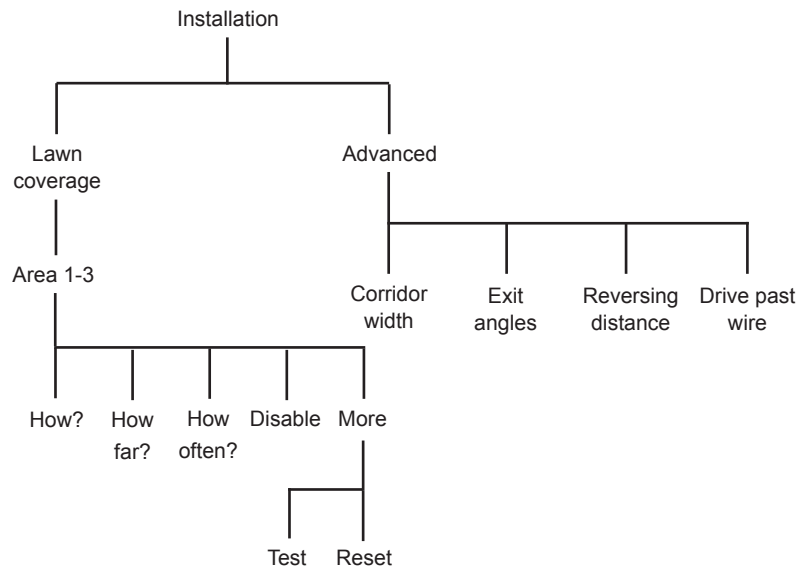

This menu function is used to steer the robotic lawnmower to remote parts of a working area. This important function is used to maintain an even mowing result in the entire working area. In very complex gardens with for instance many areas which are joined by narrow passages, the mowing result can be improved by making a number of manual settings as described below.

The factory settings allow the robotic lawnmower to follow the guide wire 300 metres in 20% of the times it leaves the charging station.

### Overview

Up to three remote areas can be set. A number of unique selections are required to allow the robotic lawnmower to reach the remote area.

Select an area using the left and right arrow keys followed by **OK** to alter the settings.

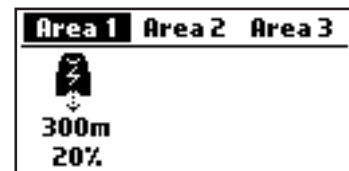

3018-313





## MENU FUNCTIONS

### Area X > How far?

Enter the distance in metres along the current wire from the charging station to the remote area where the robotic lawnmower begins mowing.

Use the number keys to specify the distance in metres.

Tip! Use the *Test* function to determine how far it is to the remote area. The distance, stated in metres, will be shown in the lawnmower display when **STOP** has been pressed. See *Area X > More > Test* on page 51. The measured distance shown in the display can be saved directly to the selected remote area. Any current value will be overridden by the new measured distance.

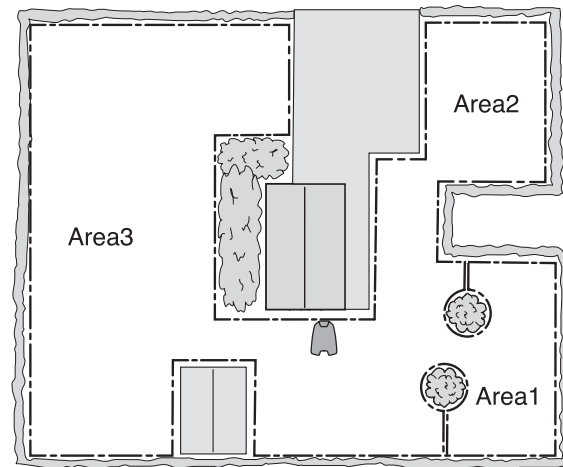

3023-017

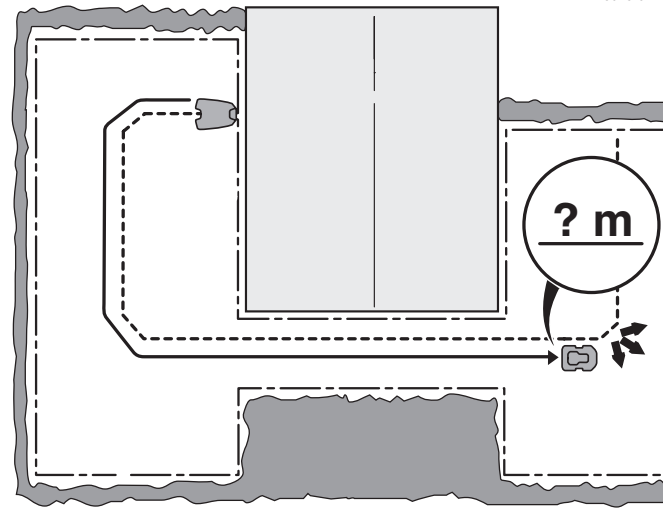

3023-018

### Area X > How often?

How often the robotic lawnmower must be steered to the remote area is selected as a proportion of the total number of times it leaves the charging station. At all other times, the robotic lawnmower starts to mow at the charging station.

Select the percentage that corresponds to the size of the remote area relative to the total working area. If the remote area is for instance half of the total working area, 50% must be selected. A lower figure must be specified if the remote area is smaller. If more areas are used, take into account that the total figure cannot exceed 100%.

Compare with the examples in see 7 *Garden examples* on page 58.

Use the number keys to specify share as a percentage.

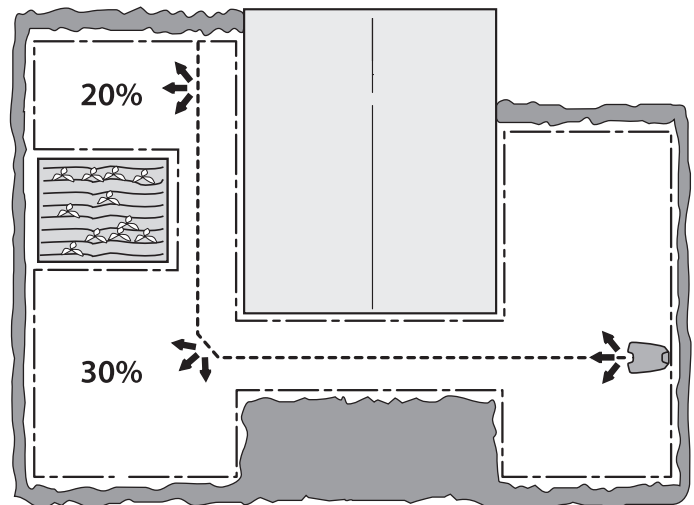

3023-019

### Area X > Disable/Enable

Each area can be disabled and enabled without having to reenter the settings. Select Disable/Enable and press **OK**.





---

## MENU FUNCTIONS

---

### Area X > More > Test

Testing selected settings can be seen as a natural part of the installation.

Using the *Test* function, the robotic lawnmower travels the farthest distance from the loop allowed by the selected corridor width.

To test the selected settings:

1. Place the robotic lawnmower in the charging station.
2. Use the down and the right/left arrow keys to select the area to be tested from the Overview screen. Press **OK**.
3. Select **More** and press **OK**.
4. Select **Test** and press **OK**.
5. Press **START** and close the display hatch.
6. The robotic lawnmower will now leave the charging station and begin following the guide loop toward the remote area. Check that the robotic lawnmower can follow the loop all along the required distance.
7. The test is approved when the robotic lawnmower can follow the guide loop to the required starting point without any problem.

How to measure the distance to a remote area:

1. Park the robotic lawnmower in the charging station.
2. In the *Area X > How far?* menu function, enter a distance which beyond any doubt exceeds the real figure. The maximum distance that can be entered is 500 metres.
3. Select *Area X > More > Test* and press **OK**.
4. Press **START** and close the display hatch.
5. Press **STOP** at the required position. The distance is now shown in the display. This figure can now be saved in *Area X > How far?*

### Reset

An individual area setting can be reset to the factory setting using this function. To reset an area setting, select *Area X* using the left right arrow keys followed by **OK**. Select *More* and press **OK**. Select *Reset* and press **OK**.



# MENU FUNCTIONS

## Advanced

Under the *Advanced* heading, there are even more settings relating to the behaviour of the robotic lawnmower. The settings in this menu are only required if additional control of the lawnmower is definitely needed e.g. in very complex gardens. The factory settings are selected in a way that should suit most working areas.

### Corridor width

The corridor width is a measure of how far from the guide wire the robotic lawnmower is allowed to travel when it follows this to and from the charging station. The area beside the wire which the robotic lawnmower then uses is called the Corridor.

The aim of operating at varying distances from the wire is to reduce the risk of tracks forming. To reduce the risk of tracks forming, it is recommended to select the widest corridor possible allowed by the size of the working area.

The robotic lawnmower itself adjusts the corridor width according to the size of the working area when following along a guide wire. The inbuilt automatic mechanism allows the robotic lawnmower to vary the distance from the wire depending on where in the working area it is located. It automatically makes the corridor narrower in narrow passages for instance.

The factory settings can be used for many working areas, i.e. the robotic lawnmower itself can use the inbuilt functions to operate in the widest possible corridor. In more complex gardens e.g. where the guide wire is placed close to obstacles which cannot be isolated using the boundary loop, operational safety can be improved by carrying out some of the manual settings outlined below.

### Corridor width > Guide

The function AutoPassage handling will automatically adjust the guide corridor width. Only in rare occasions manual settings need to be entered. The corridor width can be set between 0 and 9.

If value 0 is specified, the robotic lawnmower will straddle the guide wire meaning it runs right over the middle of the guide wire.

Use the arrow keys to specify the required value.

The factory setting is 9.

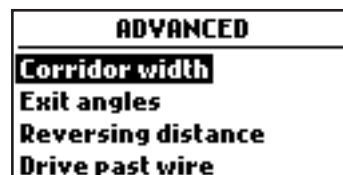

3018-314

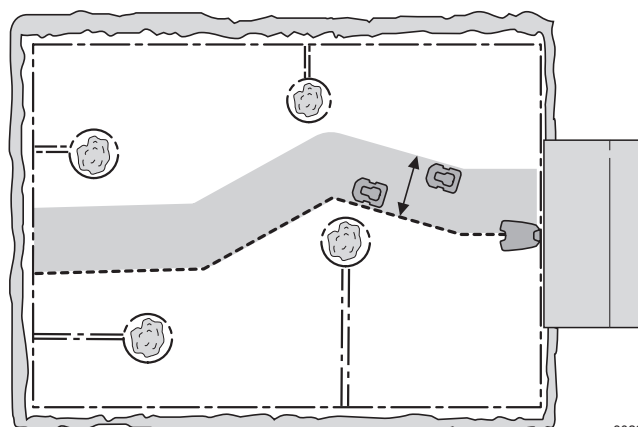

3023-020

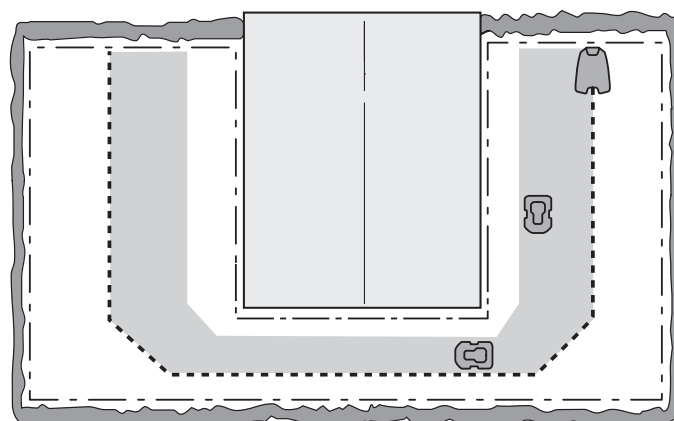

3023-021

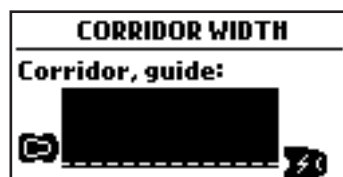

3018-315





## MENU FUNCTIONS

### Exit angles

Normally the robotic lawnmower leaves the charging station in a direction within the 90°-270° exit sector. By changing the exit angles, it makes it easier for the robotic lawnmower to reach the largest working area if the charging station is placed in a passage.

Sector 1	Sector 2
Exit angles:	90 - 270
Proportion:	100 %
270	90



3018-316

### Exit angles > Sectors

The robotic lawnmower can be set for one or two exit sectors. If the charging station is placed in a passage, two exit angles, for instance 70° - 110° and 250° - 290°, can be used.

When two exit angles are used, there is a need to also specify how often the robotic lawnmower must leave the charging station in sector 1. This is done using the *Proportion* function by initially specifying a percentage.

For instance the percentage of 75 % means that the robotic lawnmower leaves the charging station in *Sector 1* on 75% of the times and 25% of the times in sector 2.

Use the number keys to specify the required angles in degrees for the sectors and proportion as a percentage.

### Reversing distance

This functions allows you to control how far the robotic lawnmower has to reverse out from the charging station before it starts mowing. This is a useful function for instance if the charging station is placed way in under a veranda or in another limited space area.

Use the number keys to specify the required reverse distance in centimetres. The factory setting is 60 cm.

REVERSING DISTANCE	
Distance:	60 cm
300	15



3018-317





## MENU FUNCTIONS

### Drive past wire

The front of the robotic lawnmower always passes the boundary wire by a specific distance before the mower turns around. The default distance is 32 cm, but this can be changed if required. A figure between 15 and 50 can be selected.

Note that the distance given is only an approximate value and should be regarded as a guide. In reality, the actual distance the robotic mower passes the boundary wire can vary.

Specify the number of centimetres you want the robotic lawnmower to pass the boundary wire and press **OK**.

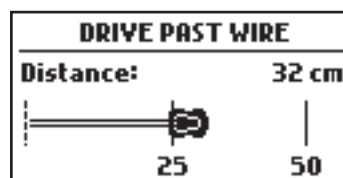

3018-318

## 6.8 Settings

This selection allows you to carry out changes to the robotic lawnmower's general settings.



### ECO mode

This function automatically turns off the signal in the boundary loop, the guide wires and the charging station when the robotic lawnmower is not mowing, i.e. when the lawnmower is charging or is not allowed to mow due to timer settings.

ECO mode is suitable to use where there is other wireless equipment not compatible with the robotic lawnmower e.g. certain hearing loops or garage doors.

When the loop signal is turned off due to the ECO mode, the indicator lamp in the charging station flashes green. When the indicator lamp flashes green the robotic lawnmower can only be started in the charging station and not out in the working area.

In ECO mode, it is very important to always press the **STOP** button before removing the robotic lawnmower from the charging station. In ECO mode it is otherwise not possible to start the robotic lawnmower. If the lawnmower has been removed by mistake without first pressing the **STOP** button, the lawnmower must be placed back in the charging station and the **STOP** button pressed. Only then can the robotic lawnmower be started inside the working area.

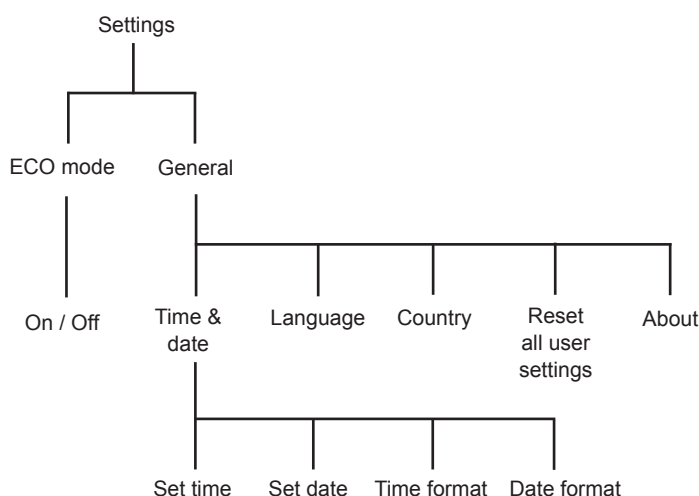

#### IMPORTANT INFORMATION

**Always press the STOP button before removing the robotic lawnmower from the charging station. In ECO mode the robotic lawnmower otherwise will not be started inside the working area.**

Select ECO mode and press **OK** to activate ECO mode.

English - 56





---

## CONTROL PANEL

---

### General

Set language and time or reset user settings to factory default.

### Time & Date

This function allows you to set current time and required time format in the robotic lawnmower.

#### Time

Enter the correct time and press **OK** to exit.

#### Time format

Move the cursor to the required time format: 12h/24h  
Exit by pressing **OK**.

#### Date

Enter current date and press **OK** to exit.

#### Date format

Place the cursor at the required date format:  
YYYY-MM-DD (year-month-day)  
MM-DD-YYYY (month-day-year)  
DD-MM-YYYY (day-month-year)  
Exit by pressing **OK**.

### Language

Set the language displayed in the menus with this function.

Place the cursor at the required language and press **OK**.

### Country

With this function you can select in what country the robotic lawnmower will work. This setting also affects the time zone adjustment.

Place the cursor at the required country and press **OK**.



---

## MENU FUNCTIONS

---

### Reset all user settings

This function allows you to reset the robotic lawnmower to the default settings it had when it left the factory.

The following settings are not altered:

- Security level
- PIN code
- Loop signal
- Date & Time
- Language
- Country

1. Select *Reset all user settings* in the menu and press **OK**.
2. Confirm by pressing **OK**.

### About

In the About menu, information about the different mower software versions, model and serial number is available.

## 7 Garden examples

### - Installation proposals and settings

Adapting the robotic lawnmower's settings and guide wire positions according to the shape of the garden makes it easier for the robotic lawnmower to frequently reach all parts of the garden and in doing so achieve a perfect mowing result.

Different gardens may require different settings. The following pages outline a number of examples of gardens with installation proposals and settings.

For more detailed information about the different settings, see *6 Menu functions on page 42*.

There is more installation help on [www.gardena.com](http://www.gardena.com).

#### IMPORTANT INFORMATION

**The default setting for the robotic lawnmower has been chosen to work in as many different gardens as possible. The settings only need to be adjusted when special installation conditions exist.**



# GARDEN EXAMPLES

Installation proposals and settings	
Area	150 m <sup>2</sup> . Open and level area.
Timer	R100Li, R100LiC 08:00-14:00 Monday, Wednesday, Friday  R130Li, R130LiC, R160Li 08:00-13:00 Monday, Wednesday, Friday
Lawn coverage	Factory setting
Remarks	The timer should be used to prevent the grass looking trampled since the area is significantly less than the maximum capacity of the robotic lawnmower.
Area	500 m <sup>2</sup> . A number of islands and a 35% slope.
Timer	R100Li, R100LiC 08:00-18:30 Monday to Saturday  R130Li, R130LiC, R160Li 08:00-16:30 Monday to Saturday
Lawn coverage	Factory setting
Remarks	Lay the guide wire at an angle over the steep slope.

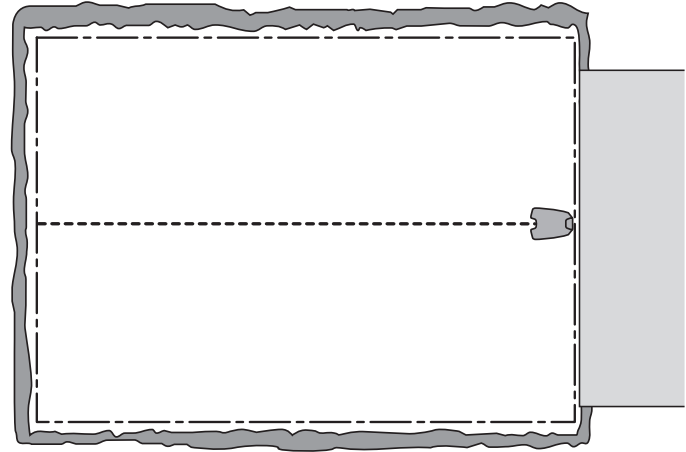

3023-022

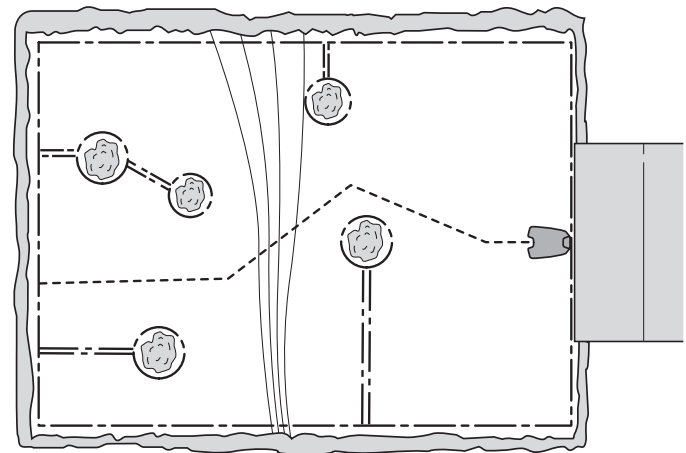

3023-023

# GARDEN EXAMPLES

Area	800 m <sup>2</sup> . L-shaped garden with charging station installed in the narrow area. Contains a couple of islands.
Timer	R100Li, R100LiC 07:00-24:00 Monday to Saturday  R130Li, R130LiC, R160Li 08:00-22:00 Monday to Saturday
Lawn coverage	Area 1: <i>How? Guide</i> <i>How far? x m</i> <i>How often? 60%</i>
Remarks	The <i>Proportion (How often)</i> for <i>Guide</i> must be specified as a value corresponding to the largest part of the working area as most of the working area can easily be reached by the robotic lawnmower following the guide wire out from the charging station.
Area	1,000 m <sup>2</sup> . U-shaped garden linked with a narrow passage.
Timer	R100Li, R100LiC 06:00-24:00 Monday to Sunday  R130Li, R130LiC, R160Li 07:00-24:00 Monday to Saturday
Lawn coverage	Area 1: <i>How? Guide</i> <i>How far? x m</i> <i>How often? 40%</i>
Remarks	The guide wire must be placed along the narrow passage to ensure the robotic lawnmower can with ease locate the left hand side of the working area. The <i>Proportion 40% (How often)</i> is selected as the left hand area is nearly half of the total area.

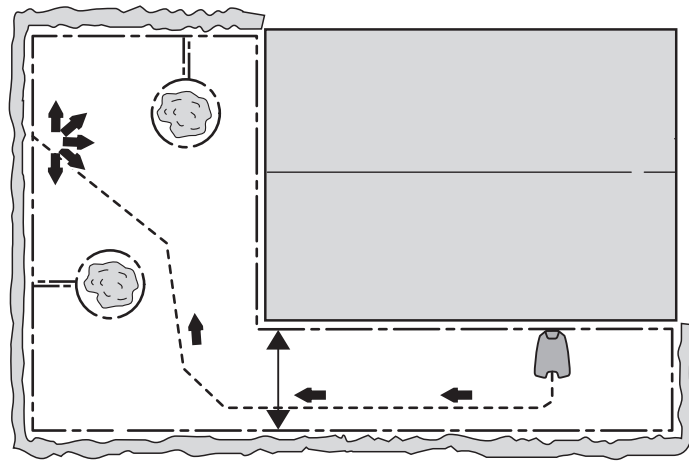

3023-024

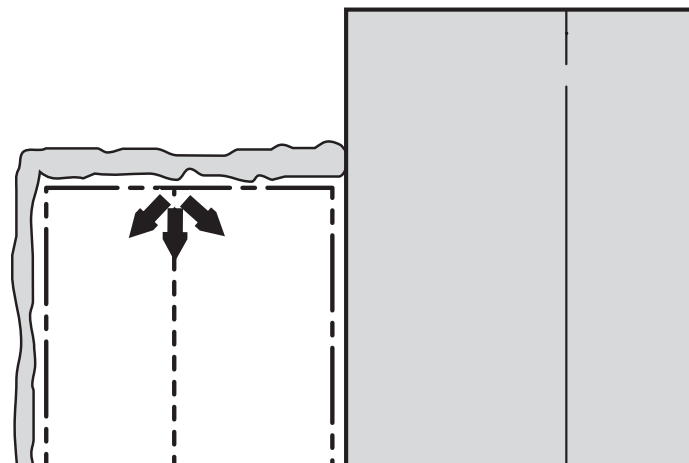

3023-025

## GARDEN EXAMPLES

Area	800 m <sup>2</sup> . Unsymmetrical working area with a narrow passage and a number of islands.
Timer	R100Li, R100LiC 07:00-24:00 Monday to Saturday  R130Li, R130LiC, R160Li 08:00-22:00 Monday to Saturday
Lawn coverage	Factory setting
Remarks	The guide wire must be placed along the narrow passage to ensure that the robotic lawnmower can with ease locate the charging station from the right hand side of the working area. As the right hand area is only a small part of the working area, the <i>Lawn coverage</i> factory settings can be used.
Area	800 m <sup>2</sup> . Three areas linked with two narrow passages.
Timer	R100Li, R100LiC 07:00-24:00 Monday to Saturday  R130Li, R130LiC, R160Li 08:00-22:00 Monday to Saturday
Lawn coverage	Area 1: <i>How? Guide</i> <i>How far? x m</i> <i>How often? 25%</i>  Area 2: <i>How? Guide</i> <i>How far? x m</i> <i>How often? 25%</i>
Remarks	As the working area contains several areas linked by narrow passages, <i>Lawn coverage</i> must be used to create several areas to obtain an even mowing result across the entire working area.

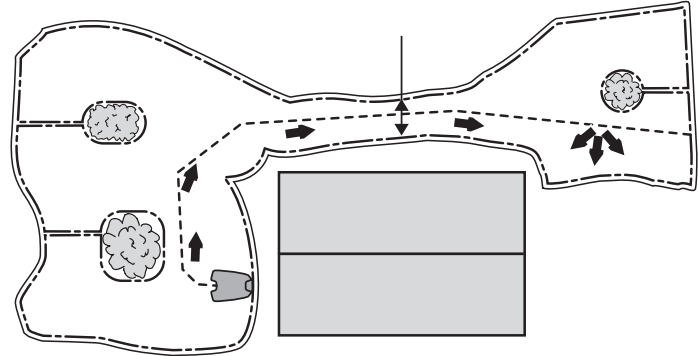

3023-026

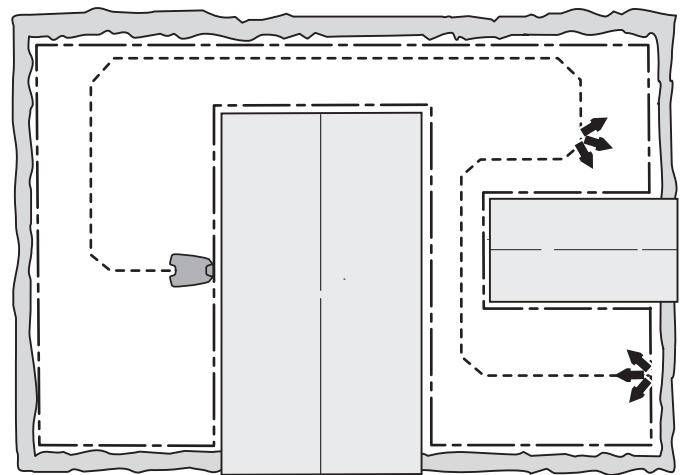

3023-027



## GARDEN EXAMPLES

Area	500 m <sup>2</sup> + 100 m <sup>2</sup> in a secondary area.
Timer	R100Li, R100LiC 08:00-20:30 Monday, Tuesday, Thursday, Friday, Saturday  R130Li, R130LiC, R160Li 08:00-18:30 Monday, Tuesday, Thursday, Friday, Saturday
Lawn coverage	Factory setting
Remarks	The secondary area is cut using the <i>Secondary area</i> mode on Wednesday and Sunday.

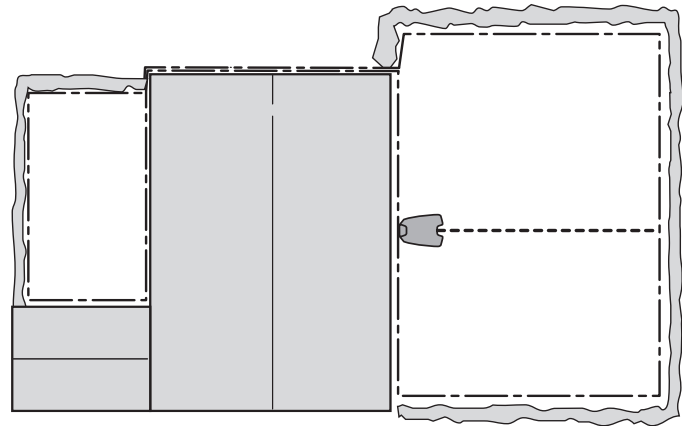

3023-001



## 8 Maintenance

For better operating reliability and longer service life: check and clean the robotic lawnmower regularly and replace worn parts if necessary. See 8.3 *Cleaning on page 64* for more details on cleaning.

When the robotic lawnmower is first used, the blade disc and blades should be inspected once a week. If the amount of wear during this period has been low, the inspection interval can be increased.

It is important that the blade disc rotates easily. The edges of the blades should not be damaged. The lifetime of the blades varies immensely and depends for instance on:

- Operating time and size of the working area.
- Type of grass.
- Type of soil.
- The presence of objects such as cones, windfalls, toys, tools, stones, roots and the like.

The normal life is 2 to 6 weeks when used at maximum area capacity and longer for smaller areas. See 8.6 *Blades on page 66* how to replace the blades.

### IMPORTANT INFORMATION

**Working with blunt blades gives a poorer mowing result. The grass is not cut cleanly and more energy is needed resulting in the robotic lawnmower not mowing such a large area.**

### 8.1 Winter storage

#### The robotic lawnmower

The robotic lawnmower must be cleaned carefully before putting it away for the winter. See 8.3 *Cleaning on page 64*.

To guarantee battery functionality and service life, it is very important to fully charge the robotic lawnmower before storing it away for the winter. Place the robotic lawnmower in the charging station with the hatch open until the battery icon in the display shows that the battery is fully charged. Then set the main switch to 0.

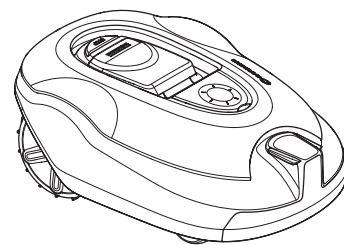

3018-203

# MAINTENANCE

## IMPORTANT INFORMATION

**The battery must be charged fully before winter storage. If the battery is not fully charged it can be damaged and in certain cases be rendered useless.**

Check the condition of wear items such as blades and bearings in the front wheels. Rectify if necessary to make sure the robotic lawnmower is in good condition prior to next season.

Store the robotic lawnmower standing on all four wheels in a dry, frost-free environment.

## The charging station

Store the charging station and power supply indoors. The boundary loop and the guide wire can be left in the ground. The ends of the wires should be protected from damp by connecting them to an original coupler or putting them in a container with grease for instance.

If it is not possible to store the charging station indoors, the charging station must be connected to the mains, the boundary wire and the guide wires the entire winter.

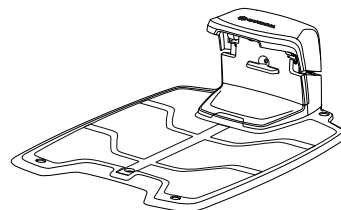

3018-215

## 8.2 After winter storage

Check whether the robotic lawnmower, contact strips or charging strips need to be cleaned before using. If the charging or contact strips appear to be burnt or coated, clean them using fine grade emery cloth. Check that the mower's time and date are correct.

## 8.3 Cleaning

It is important to keep the robotic lawnmower clean. A robotic lawnmower with a lot of grass stuck to it will find it harder to travel up slopes, perform worse and be exposed to greater wear and tear. It is recommended to clean using a soft brush.

# MAINTENANCE

## IMPORTANT INFORMATION

Never use a high-pressure washer or even running water to clean the robotic lawnmower. Never use solvents for cleaning.

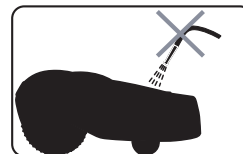

3012-271

## Chassis and blade disc

1. Set the main switch to position 0.
2. Wear protective gloves.
3. Lift the robotic lawnmower onto its side.
4. Clean the blade disc and chassis using e.g. a dish brush.

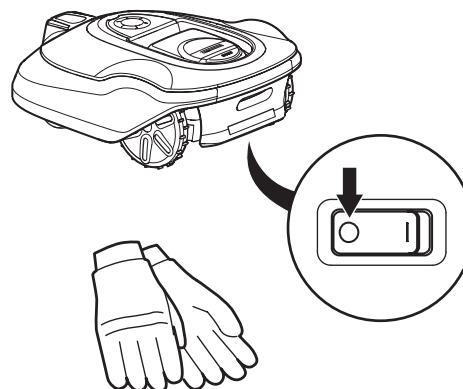

3018-213

3012-272

If long blades of grass or other objects find their way in, these may impede the blade disc. Even a slight braking effect leads to a higher consumption of energy and longer mowing times, and at worst will prevent the robotic lawnmower from being able to mow a large lawn.

## Chassis

Clean the underside of the chassis. Brush or wipe with a damp cloth.

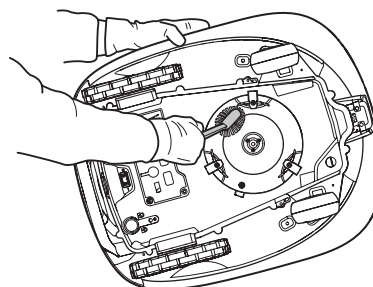

3018-227

## Wheels

Clean around the front wheel and rear wheels as well as the front wheel bracket.

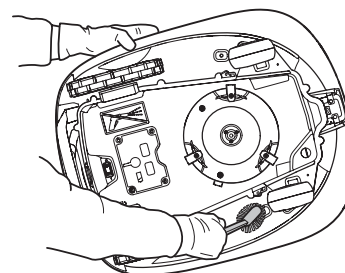

3018-228

## Body

Use a damp, soft sponge or cloth to clean the body. If the body is very dirty it may be necessary to use a soap solution or washing-up liquid.

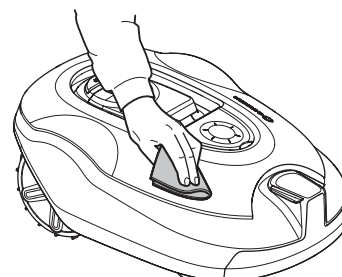

3018-229

## Charging station

Clean the charging station regularly from grass, leaves, twigs and other objects that may impede docking.

# MAINTENANCE

## 8.4 Transport and moving

Secure the machine during transport. It is important that the robotic lawnmower does not move when it is being transported, for instance, between lawns.

The contained lithium-ion-batteries are subject to the Dangerous Goods Legislation requirements.

For commercial transports e.g. by third parties, forwarding agents, special requirement on packaging and labeling must be observed.

For preparation of the item being shipped, consulting an expert for hazardous material is required. Please also observe possibly more detailed national regulations.

Tape or mask off open contacts and pack up the battery in such a manner that it cannot move around in the packaging.

## 8.5 In the event of a thunderstorm

To reduce the risk of damage to electrical components in the robotic lawnmower and its charging station, we recommend that all connections to the charging station are disconnected (power supply, boundary wire and guide wires) if there is a risk of a thunderstorm.

1. Make sure the wires are marked with the supplied markers to simplify reconnecting. The charging station's connections are marked AR, AL, G1.
2. Disconnect all wires.
3. Close the cover to the charging station to protect the connections from rain.
4. Connect all the wires if there is no longer a risk of thunder. It is important that each wire is connected to the right place.

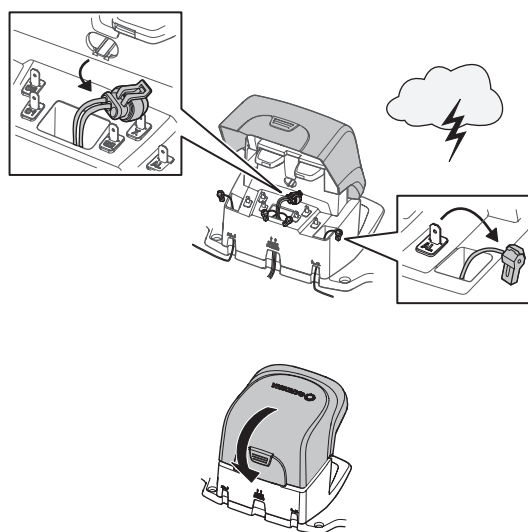

3018-237

## 8.6 Blades



### WARNING

**Always use original blades and screws when replacing. Only replacing the blades and reusing the screw can result in a screw wearing during mowing and shearing. The blades can then be propelled from under the body and cause serious injury.**

There are three blades on the robotic lawnmower, which are screwed into the blade disc. All three blades and screws must be replaced at the same time to obtain a balanced cutting system.

Use GARDENA genuine blades only.

English - 66

# MAINTENANCE

To replace the blades:

1. Set the main switch to position 0.
2. Wear protective gloves.
3. Turn the robotic lawnmower upside down.

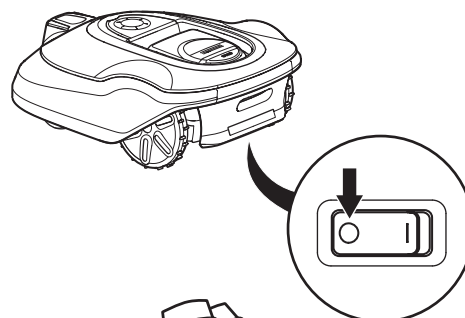

3018-213



3012-272

4. Remove the three screws. Use a straight slot or cross-tip screwdriver.
5. Remove the blade and the screw.
6. Screw on the new blade and the new screw. Check that the blades can pivot freely.

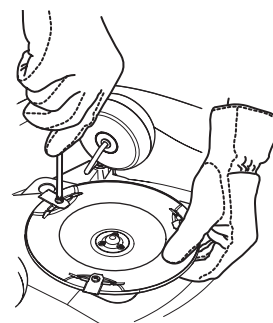

3018-231

## 8.7 Software update

Owners of GARDENA robotic lawnmowers can download regular software updates from the GARDENA website and install them on their robotic lawnmowers. Registered users will be notified of this by email. To download new software, the robotic lawnmower is connected to a computer using the accompanying USB cable.

1. Connect the USB cable between your computer and the robotic lawnmower.
  - Remove the service outlet plug on the bottom of the mower. The service outlet is located beside the main switch.
  - Connect the USB cable to the computer's USB ports.
  - Connect the USB cable to the robotic lawnmower service outlet. The USB cable can only be connected in one way.
2. Set the main switch to position 1.
3. Follow the software update instructions from your received email.
4. When the mower programming is completed disconnect the USB cable and fit the service outlet plug. If the seal on the service outlet plug is visibly damaged, the entire plug must be replaced. Make sure the plug is locked completely.

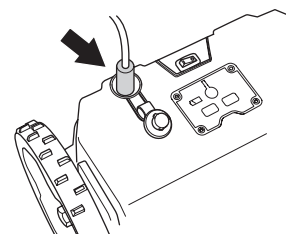

3018-256

# MAINTENANCE

## 8.8 Battery

The battery is maintenance-free, but has a limited service life of 2 to 4 years.

Battery service life is dependent on the length of the season and how many hours a day the robotic lawnmower is used. A long season or many hours of use per day means that the battery must be replaced more regularly.

Only charge the battery in the included charging station. Always use the original power supply unit. Incorrect use may result in electric shock, overheating or leaking of corrosive liquid from the battery. In the event of leakage of electrolyte flush with water/neutralizing agent, seek medical help if it comes in contact with the eyes.

### IMPORTANT INFORMATION

**Do not try to recharge non-rechargeable batteries.**

## Replacing battery

If the operating times for the robotic lawnmower are shorter than normal between charges, it indicates that the battery is getting old and eventually needs replacing. The battery is fine as long as the robotic lawnmower maintains a well-cut lawn.

### IMPORTANT INFORMATION

**Always use original batteries. Compatibility with other batteries cannot be guaranteed. The appliance must be disconnected from the supply mains when removing the battery.**

1. Set the main switch to position 0.
2. Turn the robotic lawnmower upside down. Place the robotic lawnmower on a soft and clean surface to avoid scratching the body and the display cover.
3. Clean around the battery cover.
4. Unscrew the four screws to the battery cover (Torx 20) and remove the battery cover.
5. Carefully lift out the battery and release the connectors. NOTE! Do not pull the cables. Hold the connectors and release the latch.
6. Connect a new original battery by pressing the connectors together until it locks.
7. Place the battery with the sticker "This side down" downwards in the battery opening.
8. Fit the battery cover without clamping the cables. If the seal on the battery cover is visibly damaged, the entire battery cover must be replaced.
9. Carefully cross-tighten the four screws for the battery cover (Torx 20).

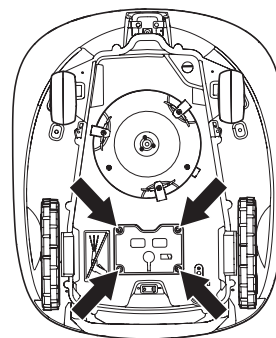

3018-251

# TROUBLESHOOTING

## 9 Troubleshooting

In this chapter, a number of messages are listed which may be shown in the display if there is a malfunction. There is a proposal as to the cause and steps to take for each message. This chapter also presents some symptoms that can guide you if the robotic lawnmower does not work as expected. More suggestions for steps to take in the event of malfunction or symptoms can be found on [www.gardena.com](http://www.gardena.com).

### 9.1 Fault messages

Below a number of messages are listed which may be shown in the display of the robotic lawnmower. Contact GARDENA Central Service if the same message appears often. See *MEMO on page 2*.

Message	Cause	Action
<i>Wheel motor blocked, left</i>	Grass or other object has wrapped around the drive wheel.	Check the drive wheel and remove the grass or other object.
<i>Wheel motor blocked, right</i>	Grass or other object has wrapped around the drive wheel.	
<i>Cutting system blocked</i>	Grass or other object has wrapped around the blade disc.	
	The blade disc lies in a pool of water.	Move the robotic lawnmower and if possible prevent the collection of water in the working area.
<i>No loop signal</i>	The power supply is not connected.	Check the wall socket connection and whether an earth-fault breaker has tripped.
	The low voltage cable is damaged or not connected.	Check that the low voltage cable is not damaged. Check that it is also properly connected to the charging station and to the power supply.
	The boundary wire is not connected to the charging station	Check that the boundary wire connectors are fitted properly to the charging station. See 3.5 <i>Connecting the boundary wire on page 27</i> .
	Boundary wire broken.	Find out where the break is, see 9.5 <i>Finding breaks in the loop wire on page 75</i> . Replace the damaged section of the loop with a new loop wire and splice using an original coupler.
	ECO mode is activated and the robotic lawnmower has attempted to start outside the charging station.	Place the robotic lawnmower in the charging station, press the <b>START</b> button and close the hatch. See 6.8 <i>Settings on page 56</i> .
	The boundary wire is laid in the wrong direction around an island.	Check that the boundary wire has been laid according to the instructions. See 3 <i>Installation on page 15</i> .
	The connection between the robotic lawnmower and the charging station has been broken.	Place the robotic lawnmower in the charging station and generate a new loop signal, see 6.4 <i>Security on page 47</i> .
	Disturbances from metal objects (fences, reinforcement steel) or buried cables close by.	Try moving the boundary wire.

## TROUBLESHOOTING

<i>Trapped</i>	The robotic lawnmower has got caught in something.	Free the robotic lawnmower and rectify the reason for it becoming trapped.
	The robotic lawnmower is stuck behind a number of obstacles.	Check if there are any obstacles which make it hard for the robotic lawnmower to move on from this location.
<i>Outside working area</i>	The boundary wire connections to the charging station are crossed.	Check that the boundary wire is connected correctly.
	The boundary wire is too close to the edge of the working area.	Check that the boundary wire has been laid according to the instructions. <i>See 3 Installation on page 15.</i>
	The working area slopes too much by the boundary loop.	
	The boundary wire is laid in the wrong direction around an island.	
	Disturbances from metal objects (fences, reinforcement steel) or buried cables close by.	Try moving the boundary wire.
	The robotic lawnmower finds it hard to distinguish the signal from an installation close by.	Place the robotic lawnmower in the charging station and generate a new loop signal, <i>see 6.4 Security on page 47.</i>
<i>Wrong PIN code</i>	Wrong PIN code has been entered. Five attempts are permitted, and the keypad is then blocked for five minutes.	Enter the correct PIN code. Contact GARDENA Central Service if you forget the PIN code. <i>See MEMO on page 2.</i>
<i>No drive</i>	The robotic lawnmower has got caught in something.	Free the robotic lawnmower and rectify the reason for the lack of drive. If it is due to wet grass, wait until the lawn has dried before using the robotic lawnmower.
	The working area includes a steep slope.	Maximum guaranteed slope is 35%. Steeper slopes should be isolated. <i>See 3.4 Installation of the boundary wire on page 21.</i>
	The guide wire is not laid at an angle on a slope.	If the guide wire is laid on a slope, it must be laid at an angle across the slope. <i>See 3.6 Installation of the guide wire on page 28.</i>
<i>Wheel motor overloaded, right</i>	The robotic lawnmower has got caught in something.	Free the robotic lawnmower and rectify the reason for the lack of drive. If it is due to wet grass, wait until the lawn has dried before using the robotic lawnmower.
<i>Wheel motor overloaded, left</i>		
<i>Charging station blocked</i>	The contact between the charging strips and contact strips may be poor and the robotic lawnmower has made a number of attempts to charge.	Put the robotic lawnmower in the charging station and check that the charging strips and contact strips make good contact.
	An object is obstructing the robotic lawnmower.	Remove the object.
<i>Stuck in charging station</i>	There is an object in the way of the robotic lawnmower preventing it from leaving the charging station.	
<i>Upside down</i>	The robotic lawnmower is leaning too much or has turned over.	Turn the robotic lawnmower the right way up.

## TROUBLESHOOTING

<i>Needs manual charging</i>	The robotic lawnmower is set to the <i>Secondary area</i> operating mode.	Place the robotic lawnmower in the charging station. This behaviour is normal and no action is required.
<i>Next start hh:mm</i>	The timer setting prevents the robotic lawnmower from operating.	Change the timer settings. See 6.3 <i>Timer</i> on page 44.
	The robotic lawnmower is currently in standby.	The robotic lawnmower needs to be in the charging station for a few hours per day, depending on the model. This is normal and no action is required.
	The clock on the robotic lawnmower is not correct.	Set the time. See <i>Time &amp; date</i> on page 61.
<i>Empty battery</i>	The robotic lawnmower cannot find the charging station.	The guide wire is broken or not connected. The battery is spent. The charging station's antenna is defective.
<i>Lifted</i>	The lift sensor has been activated as the mower has become trapped.	Free the mower
<i>Collision sensor problem, front/rear</i>	Mower body can not move freely around its chassis.	Check that the mower body can move freely around its chassis. If the problem remains, the message requires action by authorized service technician.
<i>Wheel drive problem, right/left</i>	Grass or other object is wrapped around the drive wheel.	Clean the wheels and around the wheels.
<i>Alarm! Mower switched off</i>	The alarm was activated because the mower was switched OFF.	Adjust the mower security level in the Security menu.
<i>Alarm! Mower stopped</i>	The alarm was activated because the mower was stopped.	
<i>Alarm! Mower lifted</i>	The alarm was activated because the mower was lifted.	
<i>Alarm! Mower tilted</i>	The alarm was activated because the mower was tilted.\	
<i>Electronic problem</i>	Temporary electronic or software related issue in the mower.	Restart the mower. If the problem remains, the message requires action by authorized service technician.
<i>Loop sensor problem, front/rear</i>		
<i>Charging system problem</i>		
<i>Tilt sensor problem</i>		
<i>Temporary problem</i>		
<i>Temporary battery problem</i>	Temporary battery or software related issue in the mower.	Restart the mower. Disconnect and reconnect the battery. If the problem remains, the message requires action by authorized service technician.
<i>Battery problem</i>		
<i>Charging current too high</i>	Wrong or faulty power supply unit.	Restart the mower. If the problem remains, the message requires action by authorized service technician.
<i>Connectivity problem</i>	Potential problem on the connectivity circuit board in the mower	Restart the mower. If the problem remains, the message requires action by authorized service technician.

## TROUBLESHOOTING

<i>Connectivity settings restored</i>	The connectivity settings was restored due to a fault.	Please check and change the settings if needed.
<i>Poor signal quality</i>	The connectivity circuit board in the mower is assembled upside down, or the mower itself is tilted or upside down.	Verify the mower is not upside down or tilted. If not, the message requires action by authorized service technician.

### 9.2 Info messages

A number of info messages are listed below that can be shown on the display on the robotic lawnmower. It is recommended to contact GARDENA Central Service if the same message appears often. Check that the installation is performed as described in the Operator's Manual. Contact GARDENA Central Service .

Message	Cause	Action
<i>Low battery</i>	The robotic lawnmower cannot find the charging station.	Check that the charging station and the guide wire are installed in accordance with the instructions. <i>See 3 Installation on page 15.</i>
	The guide wire is broken or not connected.	Find out where the break is and rectify it.
	The battery is spent.	Replace the battery. <i>See Replacing battery on page 68</i>
	The charging station's antenna is defective.	Check if the indicator lamp in the charging station flashes red. <i>See 9.3 Indicator lamp in the charging station on page 73.</i>
<i>Settings restored</i>	Confirmation that a <i>Reset all user settings</i> has been carried out.	This is normal. No action required.
<i>Guide not found</i>	The guide wire is not connected to the charging station.	Check that the guide wire's connector is tightly connected to the charging station. <i>See 3.6 Installation of the guide wire on page 28.</i>
	Break in the guide wire.	Find out where the break is. Replace the damaged section of the guide wire with a new loop wire and splice using an original coupler.
	The guide wire is not connected to the boundary loop.	Check that the guide wire is connected correctly to the boundary loop. <i>See 3.6 Installation of the guide wire on page 28.</i> Splice using an original coupler.
<i>Guide calibration failed</i>	The robotic lawnmower has failed to calibrate the guide wire.	Check that the guide wires are installed according to the instructions, <i>See 3.6 Installation of the guide wire on page 28</i>
<i>Guide calibration accomplished</i>	The robotic lawnmower has succeeded to calibrate the guide wire.	No action required.
<i>Difficult finding home</i>	The robotic lawnmower has been following the boundary wire several laps without finding the charging station.	The installation has not been done correctly. <i>See Laying the boundary wire on page 25.</i>
		Wrong corridor width setting on boundary wire. <i>See Finding the charging station on page 13.</i>
		The mower was started on a Secondary area with the Main area setting.

## TROUBLESHOOTING

### 9.3 Indicator lamp in the charging station

For a fully functional installation, the indicator lamp in the charging station must emit a solid green light. If something else appears, follow the troubleshooting guide below.

There is more troubleshooting help on [www.gardena.com](http://www.gardena.com). If you still need help with troubleshooting, please contact GARDENA Central Service. See *MEMO on page 2*

Light	Cause	Action
<i>Solid green light</i>	Good signals	No action required
<i>Green flashing light</i>	The signals are good and ECO mode is activated.	No action required. For more information on ECO mode, see <i>6.8 Settings on page 56</i> .
<i>Blue flashing light</i>	The boundary loop is not connected to the charging station	Check that the boundary wire connectors are fitted properly to the charging station. See <i>3.5 Connecting the boundary wire on page 27</i> .
	Break in the boundary loop	Find out where the break is. Replace the damaged section of the loop with a new loop wire and splice using an original coupler.
<i>Red flashing light</i>	Interruption in the charging station's antenna	Contact GARDENA Central Service. See <i>MEMO on page 2</i>
<i>Solid blue light</i>	Weak signal as the boundary wire is too long. Max length is 800 metres.	No steps have to be taken if the robotic lawnmower operates as expected.
		Shorten the boundary wire by reducing the working area or replacing islands with barriers the robotic lawnmower can collide with.
<i>Solid red light</i>	Defective circuit board in the charging station	Contact GARDENA Central Service. See <i>MEMO on page 2</i>

### 9.4 Symptoms

If your robotic lawnmower does not work as expected, follow the troubleshooting guide below.

There is a FAQ (Frequently Asked Questions) on [www.gardena.com](http://www.gardena.com) which provides more detailed answers to a number of standard questions. Contact GARDENA Central Service if you still cannot find the reason for the fault. See *MEMO on page 2*

Symptoms	Cause	Action
<i>The robotic lawnmower has difficulty docking with the charging station</i>	The charging station is on a slope	Place the charging station on a surface that is entirely level. See <i>3.2 Installation of the charging station on page 16</i> .
	The boundary wire is not laid correctly by the charging station.	Check that the charging station has been installed according to the instructions. See <i>3.2 Installation of the charging station on page 16</i> .

## TROUBLESHOOTING

<i>Uneven mowing results</i>	The robotic lawnmower works too few hours per day.	Increase the working times. See 6.3 <i>Timer on page 44</i> . Not applicable for R100Li, R100LiCThe SensorControl senses that the lawn has been mowed more than it actually has. Increase the intensity level in the SensorControl. If this does not help, turn off the SensorControl.
	The shape of the working area requires manual settings to be made for the robotic lawnmower to find its way to all remote areas.	Also use <i>Lawn coverage</i> to steer the robotic lawnmower to one or more remote areas. See 6.7 <i>Installation on page 51</i> .
	Working area too large.	Try limiting the working area or extending the working time. See 6.3 <i>Timer on page 44</i> .
	Blunt blades.	Replace all the blades and screws so that the rotating parts are balanced. See 8.6 <i>Blades on page 66</i> .
	Accumulation of grass by the blade disc or around the motor shaft.	Check that the blade disc skid plate rotates easily. If not, screw off the blade disc and remove grass and foreign objects. See 8.4 <i>Transport and moving on page 66</i> .
<i>The robotic lawnmower runs at the wrong time</i>	The robotic lawnmower clock needs to be set.	Set the clock. See 6.8 <i>Settings on page 56</i> .
	The start and stop times for mowing are incorrect.	Reset the start time and stop time settings for mowing. See 6.3 <i>Timer on page 44</i> .
<i>The robotic lawnmower vibrates</i>	Damaged blades lead to imbalance in the cutting system.	Inspect the blades and screws and replace them if necessary. See 8.6 <i>Blades on page 66</i> .
	Many blades in the same position lead to imbalance in the cutting system.	Check that only one blade is fitted at each screw.
	Different versions (thickness) of GARDENA blades are used.	Check if the blades are of different versions.
<i>The robotic lawnmower runs, but the blade disc does not rotate</i>	The robotic lawnmower follows the guide wire to or from the charging station.	This behaviour is normal and no action is required.
	The robotic lawnmower searches for the guide wire and the battery charge is very low.	This behaviour is normal and no action is required.
<i>The robotic lawnmower mows for shorter periods than usual between charges</i>	Grass or other foreign object blocks the blade disc.	Remove and clean the blade disc. See 8.3 <i>Cleaning on page 64</i> .
	The battery is spent.	Contact GARDENA Central Service. See <i>MEMO on page 2</i>
<i>Both the mowing and charging times are shorter than usual</i>	The battery is spent.	

# TROUBLESHOOTING

## 9.5 Finding breaks in the loop wire

Breaks in the loop wire are usually the result of unintentional physical damage to the wire such as when gardening with a shovel. In countries with ground frost, also sharp stones that move in the ground can damage the wire. Breaks can also be due to the wire being stretched excessively during installation.

Mowing the grass too low right after the installation can damage wire insulation. Certain damage to the insulation may not cause disruptions until several weeks or months later.

A defective splicing of the loop wire can also lead to disruptions first several weeks after the splice was done. A faulty splice can, for example, be the result of the original coupler not being pressed together hard enough with a pair of pliers, or that a coupler of lower quality than the original coupler has been used. Please first check all known splices before further troubleshooting is done.

A wire break can be located by gradually halving the distance of the loop where the break may have occurred until there is only a very short section of the wire left.

The following method does not work if ECO mode is activated. Make sure first that ECO mode is turned off. See 6.8 Settings on page 56.

1. Check that the indicator lamp in the charging station flashes blue, which indicates a break in the boundary loop. See 9.3 Indicator lamp in the charging station on page 73.

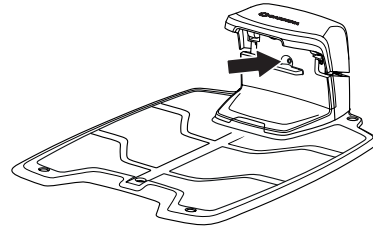

3018-216

2. Check that the boundary wire connections to the charging station are properly connected and not damaged. Check that the indicator lamp in the charging station is still flashing blue.

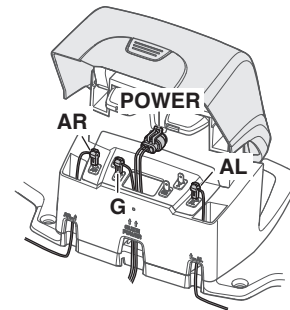

3018-224

3. Switch the connections between the guide wire and the boundary wire in the charging station.  
a) Switch connection AL and G1.  
If the indicator lamp is lit with a solid green light, then the break is somewhere on the boundary wire between AL and the point where the guide wire is connected to the boundary wire (thick black line in the illustration).

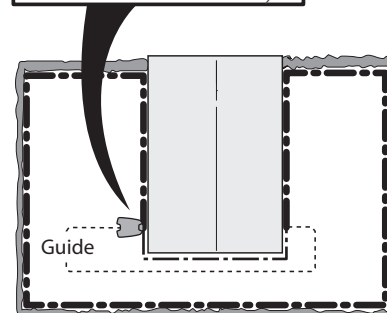
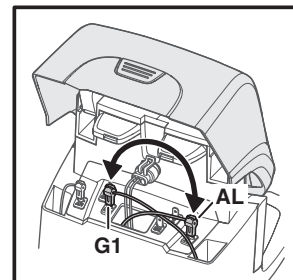

3018-225



## TROUBLESHOOTING

b) Put AL and G1 back in their original positions. Then switch AR and G1.

If the indicator lamp is lit with a solid green light, then the break is somewhere on the boundary wire between AR and the point where the guide wire is connected to the boundary wire (thick black line in the illustration).

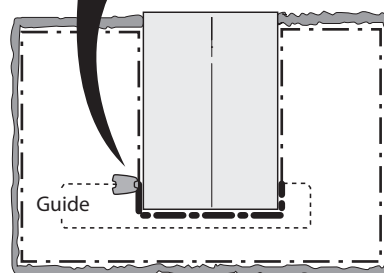
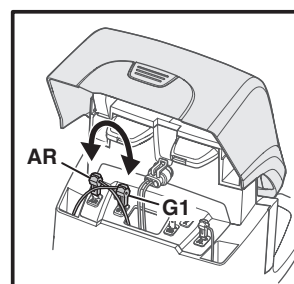

3018-232

4. a) Assume that the indicator lamp is lit with a solid green light in test 3a) above. Reset all connections to their original positions. Then disconnect AR. Connect a new loop wire to AR. Connect the other end of this new loop wire somewhere at the centre of the installation.

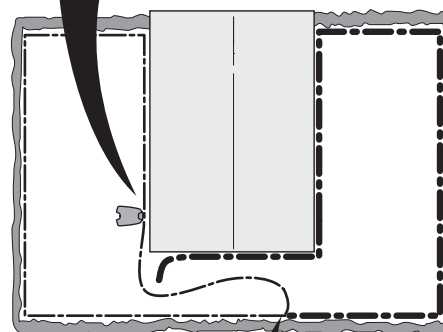
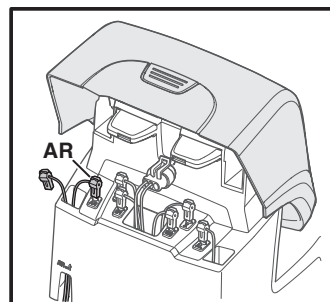

If the indicator lamp is green, then the break is somewhere in the wire between the disconnected end to the point where the new wire is connected (thick black line in the illustration).

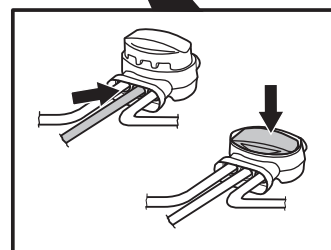

3018-233





## TROUBLESHOOTING

In that case, move the connection for the new wire closer to the disconnected end (roughly at the middle of the suspected wire section) and check again if the indicator lamp is green.

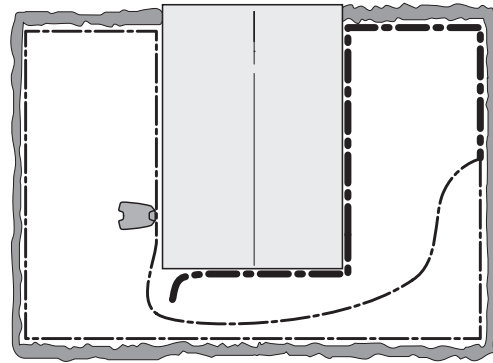

3023-029

Continue until only a very short section of the wire remains which is the difference between a flashing blue light and a solid green light.

b) If the indicator lamp is solid green in test 3b) above, a similar test is carried out but with the new loop wire connected to AL instead.

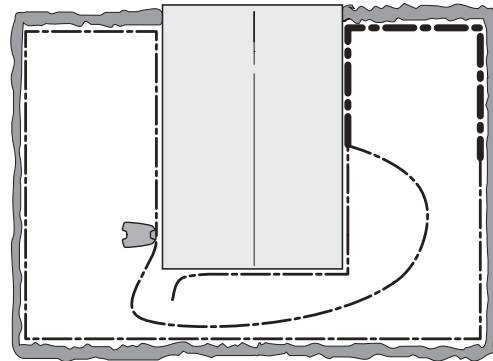

3023-030

5. When the break is found, the damaged section must be replaced with a new wire. The damaged section can be cut out if it is possible to shorten the boundary wire. Always use original couplers.

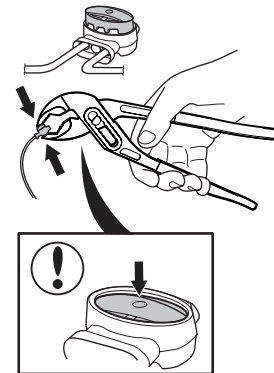

3012-1323



# TECHNICAL DATA

## 10 Technical Data

Data	GARDENA R100Li, R100LiC	GARDENA R130Li, R130LiC	GARDENA R160Li
Dimensions			
Length	63 cm	63 cm	63 cm
Width	51 cm	51 cm	51 cm
Height	25 cm	25 cm	25 cm
Weight	9,8 kg	9,8 kg	9,8 kg
Electrical system			
Battery, Special Lithium-Ion	Lithium-Ion battery, 18 V, DC/2.1Ah, Art. No. 584 85 28-01	Lithium-Ion battery, 18 V, DC/2.1Ah, Art. No. 584 85 28-01	Lithium-Ion battery, 18 V, DC/2.1Ah, Art. No. 584 85 28-01
Power supply	100-240 V/28 V DC	100-240 V/28 V DC	100-240 V/28 V DC
Low voltage cable length	10 m	10 m	10 m
Mean energy consumption at maximum use	7,3 kWh/month for a working area of 1000 m <sup>2</sup>	8,2 kWh/month for a working area of 1300 m <sup>2</sup>	10 kWh/month for a working area of 1600 m <sup>2</sup>
Charge current	1.3A DC	1.3A DC	1.3A DC
Average charging time	60 minutes	60 minutes	60 minutes
Average cutting time	65 minutes	65 minutes	65 minutes
Noise emissions measured in the environment as sound power*)			
Measured sound power noise level**)	58 dB (A)	58 dB (A)	58 dB (A)
Guaranteed sound power noise level	60 dB (A)	60 dB (A)	60 dB (A)
Sound pressure noise level at the operator's ear***)	47 dB (A)	47 dB (A)	47 dB (A)
Mowing			
Cutting system	Three pivoted cutting blades	Three pivoted cutting blades	Three pivoted cutting blades
Blade motor speed	2300 rpm	2300 rpm	2300 rpm
Power consumption during cutting	25 W +/- 20 %	25 W +/- 20 %	25 W +/- 20 %
Cutting height	2-6 cm	2-6 cm	2-6 cm
Cutting width	22 cm	22 cm	22 cm
Narrowest possible passage	60 cm	60 cm	60 cm
Maximum angle for cutting area	35 %	35 %	35 %
Maximum angle for boundary wire	15 %	15 %	15 %
Maximum length boundary wire	800 m	800 m	800 m
Maximum length guide wire	400 m	400 m	400 m
Working capacity	1000 m <sup>2</sup> +/- 20 %	1300 m <sup>2</sup> +/- 20 %	1600 m <sup>2</sup> +/- 20 %
IP-classification			
Robotic lawnmower	IPX4	IPX4	IPX4
Charging station	IPX1	IPX1	IPX1
Power supply	IPX4	IPX4	IPX4

\* Noise emissions in the environment measured as sound power ( $L_{WA}$ ) in conformity with EC directive 2000/14/EC. The guaranteed sound power level includes variation in production as well as variation from the test code with 1-3 dB(A).

The noise emission declarations conforms to EN 50636-2-107:2015

\*\*\*) Noise emissions uncertainties  $K_{WA}$ , 2 dB (A)

\*\*\*\*) Sound pressure noise uncertainties  $K_{PA}$ , 2-4 dB (A)

Full compatibility cannot be guaranteed between the robotic lawnmower and other types of wireless systems such as remote controls, radio transmitters, hearing loops, buried electric animal fencing or similar.

English - 78

---

# GUARANTEE TERMS

---

## 11 Guarantee terms

GARDENA guarantees this product's functionality for a period of two years (from date of purchase). The guarantee covers serious faults relating to materials or manufacturing faults. Within the guarantee period, we will replace the product or repair it at no charge if the following terms are met:

- The robotic lawnmower and the charging station may only be used in compliance with the instructions in this Operator's Manual.
- Users or non-authorized third parties must not attempt to repair the product.

Examples of faults which are not included in the guarantee:

- Damage caused by water seepage from underneath the robotic lawnmower. This damage is normally caused by cleaning or irrigation systems or holes/hollows in the working area when pools of water are formed when it rains.
- Damage caused by lightning.
- Damage caused by improper battery storage or battery handling.
- Damage caused by using a battery that is not a GARDENA original battery.
- Damage caused by not using GARDENA original spare parts and accessories, such as blades and installation material.
- Damage to the loop wire.

The blades are seen as disposable and are not covered by the guarantee.

If an error occurs with your GARDENA robotic lawnmower, please contact GARDENA Central Services (see *MEMO on page 2*) for further instructions. Please have the receipt and the robotic lawnmower's serial number at hand when contacting GARDENA Central Service.



---

## ENVIRONMENTAL INFORMATION

---

### 12 Environmental information

The symbol on the GARDENA robotic lawnmower or its packaging indicates that this product cannot be treated as domestic waste. It should instead be left at a suitable recycling centre to recycle its electronic components and batteries. For disassembling of the battery, *See Replacing battery on page 68.*

By ensuring that this product is taken care of correctly, you can help to counteract the potential negative impact on the environment and people that can otherwise result through the incorrect waste management of this product.

For more detailed information about recycling this product, contact your municipality, your domestic waste service or the shop from where you purchased the product.



8032-019



# EC DECLARATION OF CONFORMITY

## 13 EC Declaration of Conformity

### EC declaration of conformity (Only applicable to European versions)

**Husqvarna AB**, SE-561 82 Huskvarna, Sweden, tel.: +46-36-146500, hereby declares under sole responsibility that the robotic lawnmowers **GARDENA R100Li**, **GARDENA R100LiC**, **GARDENA R130Li**, **GARDENA R130LiC**, **GARDENA R160Li** with serial numbers dating 2015 week 44 and onwards (the year and week is clearly stated on the rating plate, followed by the serial number), comply with the requirements of the COUNCIL'S DIRECTIVE:

- Directive "relating to machinery" **2006/42/EC**.
  - Particular requirements for robotic battery powered electrical lawnmowers **EN 50636-2-107: 2015**
  - Electromagnetic fields **EN 62233: 2008**.
- Directive on "restriction of use of certain hazardous substances" **2011/65/EU**.
- Directive "relating to noise emissions from outdoor equipment" **2000/14/EC**.  
See also the Technical Data chapter for information regarding noise emissions and the cutting width. The notified body 0404, SMP Svensk Maskinprovning AB, Box 7035, SE 750 07 Uppsala, Sweden, has issued a report regarding the assessment of conformity according to annex VI to the Council's Directive of May 8, 2000 "relating to noise emissions into the environment" 2000/14/EC. The certificate is numbered: 01/901/259 GARDENA R100Li, R100LiC, R130Li, R130LiC, R160Li
- Directive "relating to electromagnetic compatibility" **2014/30/EU** and applicable supplements.  
The following standards have been applied:
  - **EN 61000-6-3:2007/A1:2011** (emission).
  - **EN 61000-6-1:2007** (immunity).

Huskvarna, 26 October 2015



Eric Stegemyr

Vice President Electric Category

Director R&D Electric Category (acting)

(Authorized representative for Husqvarna AB and responsible for technical documentation)





ORIGINAL INSTRUCTIONS

We reserve the right to make changes without prior notice.  
Copyright © 2015 GARDENA Manufacturing GmbH.  
All rights reserved.

115 78 08-26