

# Microwave oven

---

## User manual

NQ50A6139\*\*

---



**SAMSUNG**

# Contents

<b>Safety instructions</b>	<b>3</b>	<b>Cooking Smart</b>	<b>24</b>
Important safety instructions	3	Manual cooking	24
<b>Installation</b>	<b>8</b>	Quick & Easy	29
What's included	8	<b>Troubleshooting</b>	<b>30</b>
Installation instructions	8	Checkpoints	30
<b>Maintenance</b>	<b>11</b>	Information codes	34
Cleaning	11	<b>Technical specifications</b>	<b>35</b>
<b>Before you start</b>	<b>12</b>	<b>Appendix</b>	<b>36</b>
Control panel	12	Open Source Announcement	36
Replacement (repair)	12		
Care against an extended period of disuse	12		
Clock	13		
About microwave energy	13		
Cookware for microwave	14		
<b>Operations</b>	<b>15</b>		
Feature overview	15		
Microwave mode	16		
Auto mode	18		
Special functions	21		
More Functions	22		
System Settings	23		
AP Easy Setup	23		

## Safety instructions

### IMPORTANT SAFETY INSTRUCTIONS

READ CAREFULLY AND KEEP FOR FUTURE REFERENCE.

**WARNING:** If the door or door seals are damaged, the oven must not be operated until it has been repaired by a competent person.

**WARNING:** It is hazardous for anyone other than a competent person to carry out any service or repair operation that involves the removal of a cover which gives protection against exposure to microwave energy.

**WARNING:** Liquids and other foods must not be heated in sealed containers since they are liable to explode.

**WARNING:** Only allow children to use the oven without supervision when adequate instructions have been given so that the child is able to use the oven in a safe way and understands the hazards of improper use.

This appliance is intended to be used in household only and it is not intended to be used such as:

- staff kitchen areas in shops, offices and other working environments;
- farm houses;

- by clients in hotels, motels and other residential environments;
- bed and breakfast type environments.

Only use utensils that are suitable for use in microwave ovens.

When heating food in plastic or paper containers, keep an eye on the oven due to the possibility of ignition.

The microwave oven is intended for heating food and beverages. Drying of food or clothing and heating of warming pads, slippers, sponges, damp cloth and similar may lead to risk of injury, ignition or fire.

If smoke is observed (emitted), switch off or unplug the appliance and keep the door closed in order to stifle any flames.

Microwave heating of beverages can result in delayed eruptive boiling, therefore care must be taken when handling the container.

The contents of feeding bottles and baby food jars shall be stirred or shaken and the temperature checked before consumption, in order to avoid burns.

## Safety instructions

---

Eggs in their shell and whole hard-boiled eggs should not be heated in microwave ovens since they may explode, even after microwave heating has ended.

The oven should be cleaned regularly and any food deposits removed.

Failure to maintain the oven in a clean condition could lead to deterioration of the surface that could adversely affect the life of the appliance and possibly result in a hazardous situation.

The appliance is intended to be used built-in only. The appliance shall not be placed in a cabinet.

Metallic containers for food and beverages are not allowed during microwave cooking.

The care should be taken not to displace the turntable when removing containers from the appliance.

(Turntable models only)

The appliance shall not be cleaned with a steam cleaner.

The appliance should not be cleaned with a water jet.

The appliance is not intended for installing in road vehicles, caravans and similar vehicles etc.

This appliance is not intended for use by persons (including children) with reduced physical, sensory or mental capabilities, or lack of experience and knowledge, unless they have been given supervision or instruction concerning use of the appliance by a person responsible for their safety.

Children should be supervised to ensure that they do not play with the appliance.

This appliance can be used by children aged from 8 years and above and persons with reduced physical, sensory or mental capabilities or lack of experience and knowledge if they have been given supervision or instruction concerning use of the appliance in a safe way and understand the hazards involved. Children shall not play with the appliance. Cleaning and user maintenance shall not be made by children without supervision.

This Appliance should be allowed to disconnection from the supply after installation. The disconnection may be achieved by having the plug accessible or by incorporating a switch in the fixed wiring in accordance with the wiring rules.

---

If supply cord without plug is installed on the appliance, the means for disconnection must be incorporated in the fixed wiring in accordance with the wiring rules.

If the supply cord is damaged, it must be replaced by the manufacturer, its service agent or similarly qualified persons in order to avoid a hazard.

The method of fixing stated is not to depend on the use of adhesives since they are not considered to be a reliable fixing means.

This oven should be positioned proper direction and height permitting easy access to cavity and control area. Before using the your oven first time, oven should be operated with the water during 10 minute and then used.

If the oven generates a strange noise, a burning smell, or smoke is emitted, unplug the power plug immediately and contact your nearest service center.

---

## General safety

Any modifications or repairs must be performed by qualified personnel only. Do not heat food or liquids sealed in containers for the microwave function. Do not use benzene, thinner, alcohol, or steam or high-pressure cleaners to clean the oven.

Do not install the oven: near a heater or flammable material; locations that are humid, oily, dusty or exposed to direct sunlight or water; or where gas may leak; or an uneven surface.

This oven must be properly grounded in accordance with local and national codes. Regularly use a dry cloth to remove foreign substances from the power plug terminals and contacts.

Do not pull, excessively bend, or place heavy objects on the power cord. If there is a gas leak (propane, LP, etc) ventilate immediately. Do not touch the power cord.

Do not touch the power cord with wet hands.

While the oven is operating, do not turn it off by unplugging the power cord.

Do not insert fingers or foreign substances. If foreign substances enter the oven, unplug the power cord and contact a local Samsung service centre.

Do not apply excessive pressure or impact to the oven.

Do not place the oven over fragile objects.

Ensure the power voltage, frequency, and current matches the product specifications.

Firmly plug the power plug into the wall socket. Do not use multiple plug adapters, extension cords, or electric transformers.

Do not hook the power cord on metal objects. Make sure the cord is between objects or behind the oven.

Do not use a damaged power plug, power cord, or loose wall socket. For damaged power plugs or cords, contact a local Samsung service centre.

Do not pour or directly spray water onto the oven.

Do not place objects on the oven, inside, or on the oven door.

Do not spray volatile materials such as insecticide on the oven.

Do not store flammable materials in the oven. Because alcohol vapours can contact hot parts of the oven, use caution when heating food or drinks containing alcohol. Children may bump themselves or catch their fingers on the door. When opening/closing the door, keep children away.

# Safety instructions

## Microwave warning

Microwave heating of beverages may result in delayed eruptive boiling; always use caution when handling the container. Always allow beverages to stand at least 20 seconds before handling. If necessary, stir during heating. Always stir after heating.

In the event of scalding, follow these First Aid instructions:

1. Immerse the scalded area in cold water for at least 10 minutes.
1. Cover with a clean, dry dressing.
2. Do not apply any creams, oils, or lotions.

To avoid damaging the tray or rack, do not put the tray or rack in water shortly after cooking.

Do not use the oven for deep fat frying because the oil temperature cannot be controlled. This could result in a sudden boil over of hot oils.

## Microwave oven precautions

Only use microwave-safe utensils. Do not use metallic containers, gold or silver trimmed dinnerware, skewers, etc.

Remove wire twist ties. Electric arcing may occur.

Do not use the oven to dry papers or clothes.

Use shorter times for small amounts of food to prevent overheating or burning.

Keep the power cord and power plug away from water and heat sources.

To avoid the risk of explosion, do not heat eggs with shells or hard-boiled eggs. Do not heat airtight or vacuum-sealed containers, nuts, tomatoes, etc.

Do not cover the ventilation slots with cloth or paper. This is a fire hazard. The oven may overheat and turn off automatically and will remain off until it cools sufficiently.

Always use oven mitts when removing a dish.

Stir liquids halfway during heating or after heating ends and allow the liquid stand at least 20 seconds after heating to prevent eruptive boiling.

Stand at arms length from the oven when opening the door to avoid getting scalded by escaping hot air or steam.

Do not operate the oven when it is empty. The oven will automatically shut down for 30 minutes for safety purposes. We recommend placing a glass of water inside the oven at all times to absorb microwave energy in case the oven is started accidentally.

Install the oven in compliance with the clearances in this manual. (See Installing your microwave oven.)

Use caution when connecting other electrical appliances to sockets near the oven.

## Microwave operation precautions

Failure to observe the following safety precautions may result in harmful exposure to microwave energy.

- Do not operate the oven with the door open. Do not tamper with the safety interlocks (door latches). Do not insert anything into the safety interlock holes.
- Do not place any object between the oven door and front face or allow food or cleaner residue to accumulate on sealing surfaces. Keep the door and door sealing surfaces clean by wiping with a damp cloth and then with a soft, dry cloth after each use.
- Do not operate the oven if it is damaged. Only operate after it has been repaired by a qualified technician.  
**Important:** the oven door must close properly. The door must not be bent; the door hinges must not be broken or loose; the door seals and sealing surfaces must not be damaged.
- All adjustments or repairs must be done by a qualified technician.

## Limited warranty

Samsung will charge a repair fee for replacing an accessory or repairing a cosmetic defect if the damage to the unit or accessory was caused by the customer. Items this stipulation covers include:

- Door, handles, out-panel, or control panel that are dented, scratched, or broken.
- A broken or missing tray, guide roller, coupler, or wire rack.

Use this oven only for its intended purpose as described in this instruction manual. Warnings and Important Safety Instructions in this manual do not cover all possible conditions and situations that may occur. It is your responsibility to use common sense, caution, and care when installing, maintaining, and operating your oven.

Because these following operating instructions cover various models, the characteristics of your microwave oven may differ slightly from those described in this manual and not all warning signs may be applicable. If you have any questions or concerns, contact a local Samsung service centre or find help and information online at [www.samsung.com](http://www.samsung.com).

Use this oven for heating food only. It is intended for domestic use only. Do not heat any type of textiles or cushions filled with grains. The manufacturer cannot be held liable for damage caused by improper or incorrect use of the oven.

To avoid deterioration of the oven surface and hazardous situations, always keep the oven clean and well maintained.

### Product group definition

This product is a Group 2 Class B ISM equipment. The definition of group 2 which contains all ISM equipment in which radio-frequency energy is intentionally generated and/or used in the form of electromagnetic radiation for the treatment of material, and EDM and arc welding equipment.

For Class B equipment is equipment suitable for use in domestic establishments and in establishments directly connected to a low voltage power supply network which supplies buildings used for domestic purposes.

### Correct Disposal of This Product (Waste Electrical & Electronic Equipment)



#### (Applicable in countries with separate collection systems)

This marking on the product, accessories or literature indicates that the product and its electronic accessories (e.g. charger, headset, USB cable) should not be disposed of with other household waste at the end of their working life. To prevent possible harm to the environment or human health from uncontrolled waste disposal, please separate these items from other types of waste and recycle them responsibly to promote the sustainable reuse of material resources.

Household users should contact either the retailer where they purchased this product, or their local government office, for details of where and how they can take these items for environmentally safe recycling.

Business users should contact their supplier and check the terms and conditions of the purchase contract. This product and its electronic accessories should not be mixed with other commercial wastes for disposal.

For information on Samsung's environmental commitments and product-specific regulatory obligations, e.g. REACH, WEEE, Batteries, visit : [www.samsung.com/uk/aboutsamsung/sustainability/environment/our-commitment/data/](http://www.samsung.com/uk/aboutsamsung/sustainability/environment/our-commitment/data/)

# Installation

## What's included

Make sure all parts and accessories are included in the product package. If you have a problem with the oven or accessories, contact a local Samsung customer centre or the retailer.

## Oven at a glance

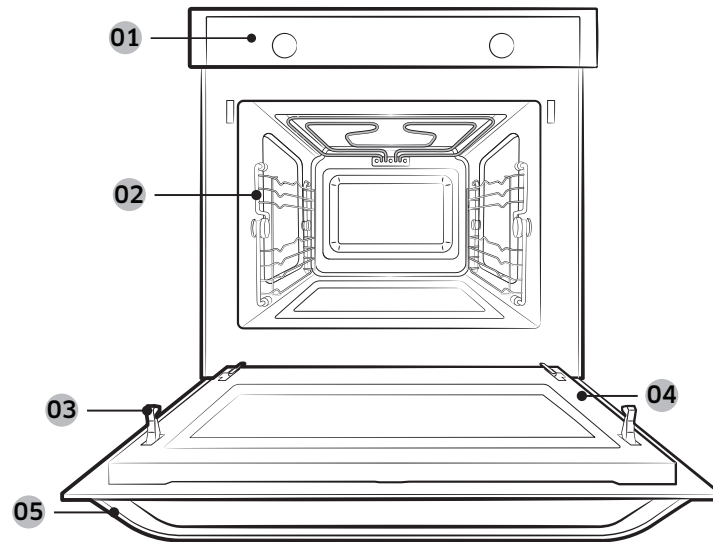

- |                  |                 |                     |
|------------------|-----------------|---------------------|
| 01 Control panel | 02 Side runners | 03 Safety door lock |
| 04 Door          | 05 Door Handle  |                     |

## Accessories

The oven comes with different accessories that help you prepare different types of food.



Ceramic tray  
(Useful for microwave mode.)

## NOTE

See the **Cooking Smart** on page **24-29** to determine the appropriate accessory for your dishes.

## Installation instructions

### General Technical Information

Electrical Supply	230 V ~ 50 Hz	
Dimensions (W × H × D)	Set size	595 x 456 x 570 mm
	Built in size	560 x 446 x 549 mm

This appliance complies with EU regulations.

### Disposal of Packaging and Appliance

Packaging is recyclable.

Packaging may consist of the following materials:

- cardboard;
- polyethylene film (PE);
- CFC-free polystyrene(PS rigid foam).

Please dispose of these materials in a responsible manner in accordance with government regulations. The authorities can provide information on how to dispose of domestic appliances in a responsible manner.

### Safety

- This appliance should only be connected by a qualified technician.
- The Oven is NOT designed for use in a commercial cooking setting.
- It should be used exclusively for cooking food in a home setting.
- The appliance is hot during and after use.
- Exercise caution when young children are present.

### Electrical Connection

The house mains to which the appliance is connected should comply with national and local regulations. Appliance should allow to disconnection of the appliance from the supply after installation. The disconnection may be achieved by having the plug accessible or by incorporating a switch in the fixed wiring in accordance with the wiring rules.

### Install in the Cabinet

Kitchen Cabinets in contact with the oven must be heatresistant up to 100 °C. Samsung will take no responsibility for damage of cabinets from the heat.

### Required Dimensions for Installation

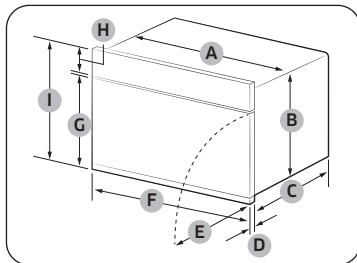

Oven (mm)

A	560	F	595
B	446	G	361
C	549	H	85
D	21	I	456
E	341		

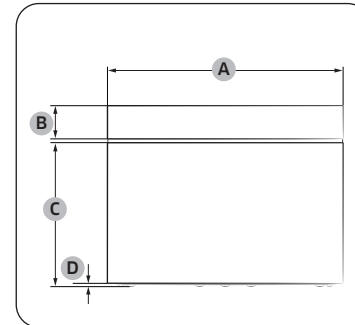

Oven (mm)

A	595
B	85
C	367
D	6

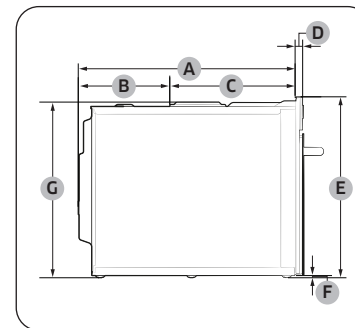

Oven (mm)

A	549	E	456
B	233	F	6
C	316	G	446
D	21		

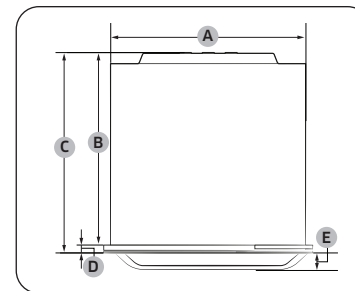

Oven (mm)

A	560	D	21
B	549	E	37
C	570		

# Installation

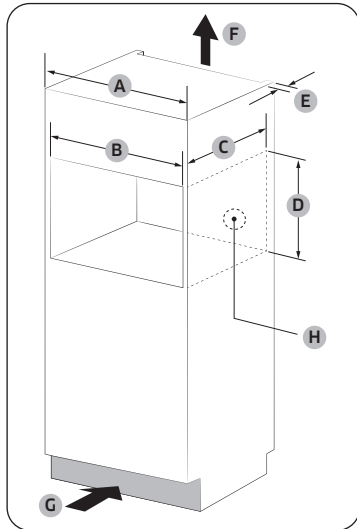

Built-in cabinet (mm)

A	600
B	Min. 564-568
C	Min. 550
D	Min. 446 / Max. 450
E	Min. 50
F	200 cm <sup>2</sup>
G	200 cm <sup>2</sup>
H	Space for power outlet (30 Ø Hole)

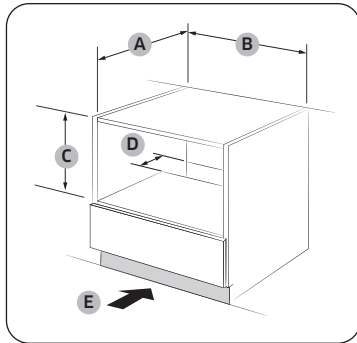

Under-sink cabinet (mm)

A	Min. 550
B	Min. 564 / Max. 568
C	Min. 446 / Max. 450
D	50
E	200 cm <sup>2</sup>

**NOTE**

Minimum height requirement (C) is for oven installation alone.

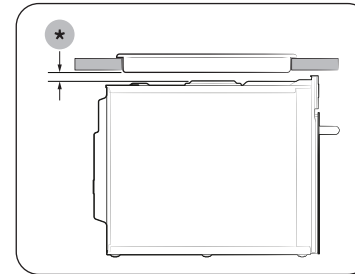

Installing with a hob

To install a hob on top of the oven, check the installation guide of the hob for the installation space requirement (\*).

**Mounting the oven**

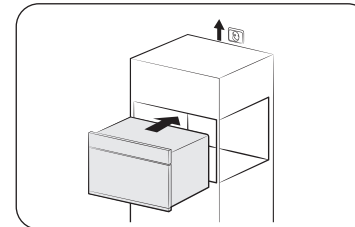

1. Slide the oven partly into the recess. Lead the connection cable to the power source.

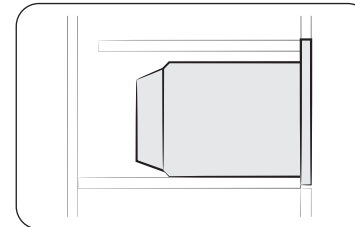

2. Slide the oven completely into the recess.

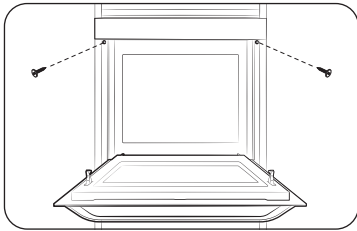

3. Fasten the oven using the two screws (4 x 25 mm) provided.

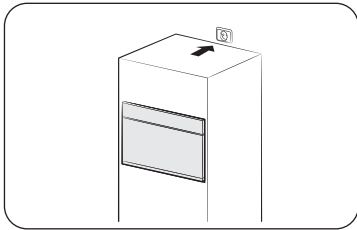

4. Make the electrical connection. Check that the appliance works.

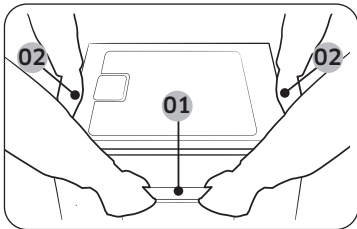

Be sure to hold the appliance with 2 side handles and door handle when unpacking the product.

- 01 Door handle
- 02 Side handle

After the installation is complete, remove the protective film, tape, and other packing material, and take out the provided accessories from inside of the oven. To remove the oven from the cabinet, first disconnect power to the oven and remove 2 screws on both sides of the oven.

## Maintenance

### Cleaning

Clean the oven regularly to prevent impurities from building up on or inside the oven. Also pay special attention to the door, door sealing, and turntable and roller ring (applicable models only).

If the door won't open or close smoothly, first check if the door seals have built up impurities. Use a soft cloth in soapy water to clean both the inner and outer sides of the oven. Rinse and dry well.

#### To remove stubborn impurities with bad smells from inside the oven

1. With an empty oven, put a cup of diluted lemon juice on the centre of the turntable.
2. Heat the oven for 10 minutes at max power.
3. When the cycle is complete, wait until the oven cools down. Then, open the door and clean the cooking chamber.

#### CAUTION

- Keep the door and door sealing clean and ensure the door opens and closes smoothly. Otherwise, the oven's lifecycle may be shortened.
- Take caution not to spill water into the oven vents.
- Do not use any abrasive or chemical substances for cleaning.
- After each use of the oven, use a mild detergent to clean the cooking chamber after waiting for the oven to cool down.

## Maintenance

### Replacement (repair)

#### ⚠ WARNING

This oven has no user-removable parts inside. Do not try to replace or repair the oven yourself.

- If you encounter a problem with hinges, sealing, and/or the door, contact a qualified technician or a local Samsung service centre for technical assistance.
- If you want to replace the light bulb, contact a local Samsung service centre. Do not replace it yourself.
- If you encounter a problem with the outer housing of the oven, first unplug the power cord from the power source, and then contact a local Samsung service centre.

### Care against an extended period of disuse

If you don't use the oven for an extended period of time, unplug the power cord and move the oven to a dry, dust-free location. Dust and moisture that builds up inside the oven may affect the performance of the oven.

## Before you start

There are a couple of components that you should know before going directly to a recipe.

### Control panel

The front panel comes in a wide range of materials and colours. For improved quality, the actual appearance of the oven is subject to change without notice.

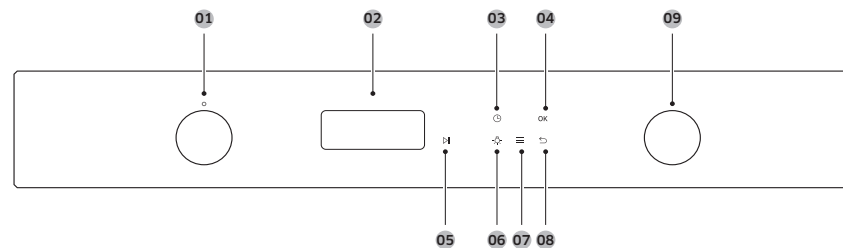

<b>01</b> Mode Dial	Turn the <b>Mode Dial</b> to wake the control panel or to select a desired cooking mode or function.
<b>02</b> Screen	Displays the menu, information, and cooking progress.
<b>03</b> Cooking Time	Tap to set the cooking time.
<b>04</b> OK	Select the current value.
<b>05</b> Start / Stop	Tap to start or stop the oven operation. Tap and hold 3 seconds during cooking to cancel.
<b>06</b> Light	Tap to turn the oven light on or off.
<b>07</b> Options	Tap to see the Options list. Tap and hold 3 seconds to see the System settings.
<b>08</b> Back	Tap to move to the previous screen or to cancel the cooking.
<b>09</b> Value Dial	Turn the <b>Value Dial</b> to adjust the setting value for your selection. Turn to the right to increase, or turn to the left to decrease.

## Clock

It is important to set the correct time to ensure correct automatic operations.



### To set the clock time

1. Tap .
2. Select Set time using the **Value Dial**, and then tap **OK**.
3. Set the current time using the **Value Dial**, and then tap **OK**. (Hour, minute, and AM/PM if necessary)

### To set the date

1. Tap .
2. Select Set date using the **Value Dial**, and then tap **OK**.
3. Set the current date using the **Value Dial**, and then tap **OK**. (Month, day, and year)

### To set the time format

1. Tap .
2. Select Time format using the **Value Dial**, and then tap **OK**.
3. Turn the **Value Dial** to select 12hr or 24hr, and then tap **OK**.

#### NOTE

- You cannot change the clock time while the oven is operating.

## About microwave energy

Microwaves are high-frequency electromagnetic waves. The oven uses the prebuilt magnetron to generate microwaves which are used to cook or reheat food without deforming or discolouring the food.

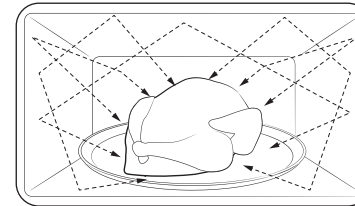

1. The microwaves generated by the magnetron are distributed uniformly through the whirling distribution system. This is why the food is cooked evenly.
2. The microwaves are absorbed down to the food up to a depth of approx. 2.5 cm. Then, the microwaves are dissipated inside the food as cooking continues.
3. The cooking time is affected by the following conditions of the food.
  - Quantity and density
  - Moisture content
  - Initial temperature (especially, when frozen)

#### NOTE

The cooked food keeps heat in its core after cooking is complete. This is why you must respect the standing time specified in this manual, which ensures cooking evenly down to the core.

## Before you start

### Cookware for microwave

Cookware used for Microwave Mode must allow microwaves to pass through and penetrate the food. Metals such as stainless steel, aluminium and copper reflect microwaves. Therefore, do not use cookware made of metallic materials. Cookware marked microwave-safe is always safe for use. For additional information on appropriate cookware refer to the following guidelines and place a glass of water or some food on the turntable.

#### Requirements:

- Flat bottom and straight sides
- Tight-fitting lid
- Well-balanced pan with handles that weigh less than the main pan

Material	Microwave-safe	Description
Aluminium foil	△	Use for a small serving size to protect against overcooking. Arcing can occur if the foil is near the oven wall or if using an excessive amount of foil.
Crusty plate	○	Do not use for preheating for more than 8 minutes.
Bone china or earthenware	○	Porcelain, pottery, glazed earthenware, and bone china are usually microwave-safe unless decorated with a metal trim.
Disposable polyester cardboard dishes	○	Some frozen foods are packaged in these dishes.







Material	Microwave-safe	Description
Fast-food packaging	○	Polystyrene cups or containers Overheating may cause these to melt.
	×	Paper bags or newspaper These may catch fire.
	×	Recycled paper or metal trims These may cause arcing.
Glassware	○	Oven-to-table ware Microwave-safe unless decorated with metal trims.
	○	Fine glassware Delicate glassware may break or crack by rapid heating.
	○	Glass jars Appropriate for warming only. Remove the lid before cooking.
Metal	×	Dishes These may cause arcing or fire.
	×	Freezer bag with twist-ties
Paper	○	Plates, cups, napkins, and kitchen paper Use to cook for a short time. These absorb excess moisture.
	×	Recycled paper Causes arcing.

Material		Microwave-safe	Description
Plastic	Containers	○	Use thermoplastic containers only. Some plastics may warp or discolour at high temperatures.
	Cling film	○	Use to maintain moisture after cooking.
	Freezer bags	△	Use boilable or ovenproof bags only.
Wax or grease-proof paper		○	Use to maintain moisture and prevent spattering.

○ : Microwave-safe      △ : Use caution      ✕ : Not microwave-safe

## Operations

### Feature overview

Feature			Temperature (Power level) range	Default temperature (Power level)	
Manual Mode		Microwave	100-900 W	900 W	
		The microwave energy enables food to be cooked or reheated without changing either the form or the colour.			
Auto Mode		Auto Cook	For cooking beginners, the oven offers a total of 15 auto cooking programmes.		
			Auto Defrost	The oven offers 5 defrosting programmes for your convenience.	
Special functions		Keep Warm	Use this only for keeping foods warm that have just been cooked.		
			Steam Clean	This is useful for cleaning light soiling with steaming.	
			Deodorisation	This is useful for deodorizing the oven. Use this function regularly to remove any unpleasant odor in your oven.	

# Operations

## Microwave mode

Microwaves are high-frequency electromagnetic waves. The microwave energy enables food to be cooked or reheated without changing either the form or the colour.

- The default temperature(or Power level) is changed to the most set temperature(or Power Level) of the last 10 settings.
- Use only microwave-safe cookware.

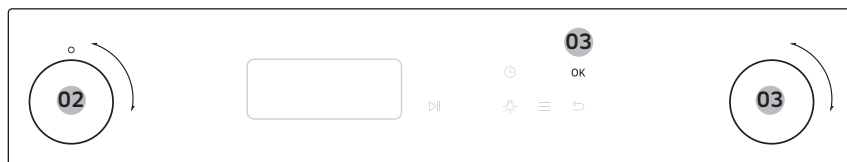

1. Put food in a microwave-safe container, then on the recommended accessory, and then close the door.
2. Use the mode dial to wake up and then select **Microwave**.
3. Tap **OK** to confirm.



4. Set the cooking time using **Value Dial** and **OK**.
5. To start cooking, tap **OK** when select Start or tap Start.
6. If you want to change power level, select "cook at Watt" and select desired power level.

Option	Description
Start	Tap OK on start, the oven start cooking
Set Cook Time	You can set the desired cooking time.
Change Power Level	You can change Power level(Watt) when set microwave or microwave combo mode.

7. When cooking is complete, you can select +30 sec using value dial. Use oven gloves to take out food.

### ⚠ CAUTION

Use only ovenproof cookware, such as glasses, potteries, or bone china without metal trim.

### Power level

Level	Percentage (%)	Output Power (W)	Description
HIGH	100	900	Use to heat up liquid.
HIGH LOW	83	750	Use to heat up and cook.
MEDIUM HIGH	67	600	
MEDIUM	50	450	Use to cook meat and heat up vegetables.
MEDIUM LOW	33	300	
DEFROST	20	180	Use to defrost before cooking.
LOW	11	100	Use to defrost vegetables.

### To change the Power level and cook time during cooking

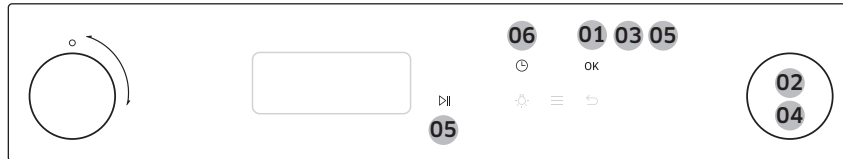

1. Tap **OK** during cooking.
2. Select power level or cook time using the **Value Dial**.
3. Tap **OK**.
4. Change the value using the **Value Dial**.
5. If you tap **OK**, you can change the value.
6. To change cooking time only, tap **⏸**. Then, change the cooking time you desire.

### To stop the operation



1. Turn the **Mode Dial** to off.
  - The oven display turns off, and the clock appears after 2 seconds.
  - The oven turns off even during cooking, and the clock appears after 2 seconds.
2. Tap **⏸**.
  - The oven stops cooking.
  - If you tap and hold **⏸** for 3 seconds, the cooking is cancelled.
3. Tap **↵**, select **Yes** using the **Value dial**, and then tap **OK**.

### Microwave

Microwaves are high-frequency electromagnetic waves. The microwave energy enables food to be cooked or reheated without changing either the form or the colour.

- Use only microwave-safe cookware.

Step 1	Step 2	Step 3	Step 4
Microwave	>	>	>
	-	<b>Cooking time</b> (Power Level)	-

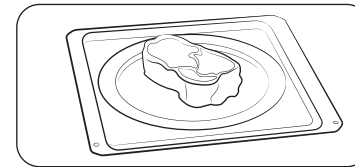

1. Put food in a microwave-safe container, then on the recommended accessory, and then close the door.
2. Follow steps 1-3 in the **Microwave mode** on page 16-17. The oven will start after set cooking time.
3. When cooking is complete, you can select +30 sec using value dial. Use oven gloves to take out food.

### CAUTION

Use only ovenproof cookware, such as glasses, potteries, or bone china without metal trim.

# Operations

## Auto mode

The oven offers 2 different auto modes for your convenience: Auto Defrost and Auto Cook. Select one that best fits your needs.

### Step 1. Select a mode



1. Use the **Mode Dial** to wake the control panel, and then select an **Auto mode**.
  - Auto Defrost (🌟), Auto Cook (🍳)
2. Tap **OK** to confirm.

### Step 2. Select a menu

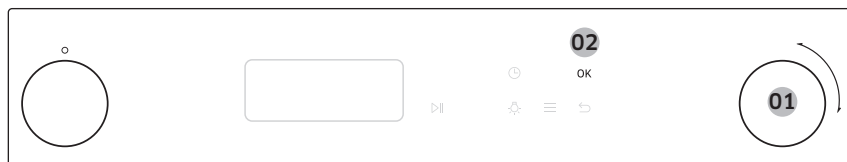

1. Turn the **Value Dial** to select the preferred programme.
2. Tap **OK** to confirm.

### Step 3. Set weight



1. Turn the **Value Dial** to set the desired weight.
2. When done, tap **OK**.
3. The display shows the menu and accessory guide. (Tap **OK**.)
4. Tap **▶||** or **OK** to start cooking.

### ⚠ CAUTION

Always use oven gloves while taking out food.

### 📖 NOTE

The cooking time is pre-programmed for each menu and, it cannot be changed.

### 🍳 Auto Cook

For cooking beginners, the oven offers a total of 15 auto cooking programmes. Take advantage of this feature to save you time or shorten your learning curve. The cooking time and temperature will be adjusted according to the selected recipe.

Step 1  
Auto cook > Step 2  
Menu > Step 3  
Weight

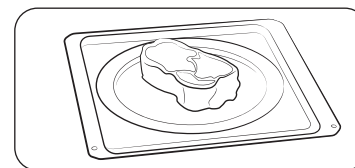

1. Put food in suitable cookware, put the cookware on the recommended accessory, and then close the door.
2. Follow steps 1-3 in the **Auto mode** section on page 18-18.
3. When cooking is complete, use oven gloves to take out food.

### ⊗ Auto defrost

The oven offers 5 defrosting programmes for your convenience. The time and power level are automatically adjusted according to the selected programme.

Step 1 > Step 2 > Step 3  
**Auto defrost** > **Menu** > **Weight**

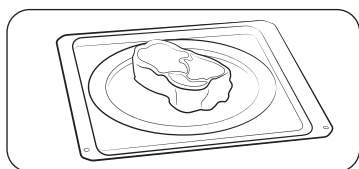

1. Put food in suitable cookware, put the cookware on the recommended accessory, and then close the door.
2. Follow steps 1-3 in the **Auto mode** section on page 18-18.
3. When cooking is complete, use oven gloves to take out food.

### Auto cooking

#### Auto cook guide

Food	Weight (kg)	Instructions
Drink	0.3 0.5	Pour the liquid into ceramic mugs and reheat uncovered. Place one mug in the centre, place 2 mugs side by side on ceramic tray. Leave them to stand in the microwave oven. Stir well after 1-2 min standing. Be careful while taking the cups out. (see safety instruction for reheating liquids.)
Plated meal	0.3-0.4 0.4-0.5	Put on a ceramic plate and cover with microwave cling film. This programme is suitable for meals consisting of 3 components (e.g. meat with sauce, vegetables and a side dish like potatoes, rice or pasta). After cooking stand for 3 min.

Food	Weight (kg)	Instructions
Frozen Plated meal	0.3-0.4 0.4-0.5	Take frozen ready meal and check if dish is suitable for microwave. Pierce film of ready meal. Put the frozen ready meal in the centre. This programme is suitable for frozen ready meals consisting of 3 components (e.g. meat with sauce, vegetables and a side dish like potatoes, rice or pasta). After cooking stand for 3 min.
Soup	0.2-0.3 0.4-0.5	Pour into a deep ceramic plate or bowl and cover with plastic lid during heating. Put soup in the centre. Stir carefully before and after 2-3 min standing.
Stew	0.2-0.3 0.4-0.5	Pour into a deep ceramic plate or bowl and cover with plastic lid during heating. Put soup in the centre. Stir carefully before and after 2-3 min standing.
Pop corn	0.1	Use special popcorn product for preparing in microwave oven. Follow the instructions of food manufacturer and put the bag in the center of ceramic tray. During this programme corn will pop and the bag will increase in volume. Be careful when taking out and opening the hot bag.
Pasta with sauce (chilled)	0.3-0.4 0.4-0.5	Put pasta (e.g. spaghetti or egg noodles) on a flat ceramic plate. Cover with microwave cling film. Stir before serving.
Baby food	0.2 0.3	Pour the meal into a ceramic deep plate. Cook covered. Stand 2-3 minutes after cooking. Before serving, stir well and check the temperature carefully.
Baby milk	0.1 0.2	Stir or shake well and pour into a sterilized glass bottle. Place into the center of ceramic tray. Cook uncovered. Shake well and stand for at least 3 minutes. Before serving, shake well and check the temperature carefully.

# Operations

Food	Weight (kg)	Instructions
Fresh vegetables	0.3-0.4 0.5-0.6	Weigh the vegetables after washing, cleaning and cutting into similar size. Put them into a glass bowl with lid. Add 45 ml water (3 tablespoons). Put bowl in the centre. Cook covered. Stand 2-3 minutes and stir after cooking.
Frozen vegetables	0.3-0.4 0.4-0.5	Put frozen vegetables, such as broccoli, carrot slices, cauliflower florets and peas into a glass bowl with lid. Add 1-2 tbsp. water. Put bowl in the centre. Cook covered. Stand 2-3 minutes and stir after cooking.
Peeled Potato	0.5-0.6 0.7-0.8	Weigh the potatoes after peeling, washing and cutting into a similar size. Put them into a glass bowl with lid. Add 45-60 ml (3-4 tablespoons) water. Put bowl in the centre. Stand 2-3 minutes and stir after cooking.
Jacket Potato	0.3-0.4 0.5-0.6	Prick each potato several times with fork. Place them on ceramic tray without peeling. Remove from oven, wrap in foil and let stand 3-5 minutes after cooking.
White rice	0.3-0.4	Weigh parboiled white rice and add double quantity of cold water. For example: when cooking 0.3 kg rice, add 600 ml cold water. Use glass pyrex bowl with lid. Put bowl in the centre. Cook covered. Stand 5 minutes and stir after cooking.
Pasta	0.2 0.4	Put the pasta in a large glass pyrex bowl and add 1~1.5 L boiling water, a pinch of salt and stir well. Cook uncovered. Stir occasionally during and after cooking. Cover during 3-5 min standing and drain thoroughly afterwards.

## NOTE

The Auto Cook Mode uses microwave energy to heat food. Therefore guidelines for cookware and other microwave safety precautions must be strictly observed when using this mode.

## Auto defrost guide

Food	Weight (kg)	Instructions
Meat	0.2-1.5	Shield the edges with aluminium foil. Turn the meat over, when the oven beeps. This programme is suitable for beef, lamb, pork, steaks, chops, minced meat. Stand for 20-90 minutes.
Poultry	0.2-1.5	Shield the leg and wing tips with aluminium foil. Turn the poultry over, when the oven beeps. This programme is suitable for whole chicken as well as for chicken portions. Stand for 20-90 minutes.
Fish	0.2-1.5	Shield the tail of a whole fish with aluminium foil. Turn the fish over, when the oven beeps. This programme is suitable for whole fishes as well as for fish fillets. Stand for 20-90 minutes.
Bread/Cake	0.1-0.8	Put bread on a piece of kitchen paper and turn over, as soon as the oven beeps. Place cake on ceramic tray and if possible, turn over, as soon as the oven beeps. (Oven keeps operating and is stopped, when you open the door.) This programme is suitable for all kinds of bread, sliced or whole, as well as for bread rolls and baguettes. Arrange bread rolls in a circle. This programme is suitable for all kinds of yeast cake, biscuit, cheese cake and puff pastry. It is not suitable for short / crust pastry, fruit and cream cakes as well as for cake with chocolate topping. Stand for 10-30 minutes.
Fruit	0.1-0.6	Distribute frozen fruit evenly on ceramic tray. This programme is suitable for fruits like raspberries, mixed berries, and tropical fruits. Stand for 5-15 minutes.

## NOTE

The Auto Defrost Mode uses microwave energy to heat food. Therefore guidelines for cookware and other microwave safety precautions must be strictly observed when using this mode.

## Special functions

### Keep Warm

The Keep Warm feature keeps food hot until it's served. Use this function to keep food warm until ready to serve.

When cooking is complete,

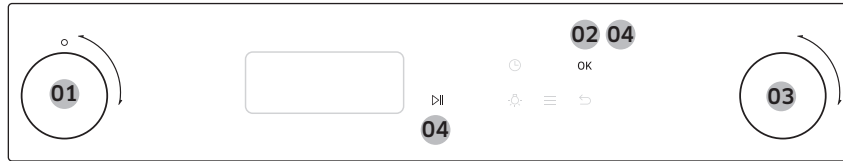

1. Use the **Mode Dial** to wake the control panel, and then select **Keep Warm** (🔥).
2. Tap **OK** to confirm.
3. Turn the **Value Dial** to select the operating time.
4. When done, tap **OK** or **▶||** to start.

### CAUTION

- Always use oven gloves while taking out food.
- Do not use this function to reheat cold foods. Use this only for keeping foods warm that just have been cooked.
- Do not run this function for more than 1 hour. Otherwise, this may affect food quality.
- To keep food crispy, do not cover the food when using this function.

### Steam cleaning

This function is useful for cleaning light soiling with steaming.

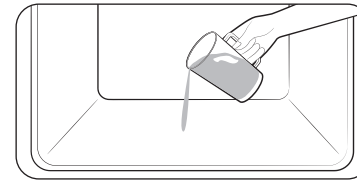

Pour 100 ml of water onto the bottom of the oven and close the oven door.



1. Use the **Mode Dial** to wake the control panel, and then select **Cleaning** (🧼).
2. Tap **OK** to confirm.
3. Tap **OK** to read guide message.
4. When done, tap **OK** or **▶||** to start.

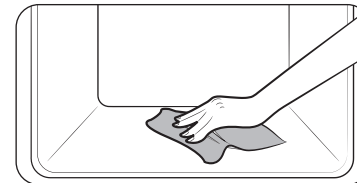

Use a dry cloth to clean inside the oven.

### WARNING

Do not open the door before the cycle is complete. The water inside the oven is very hot, and it can cause a burn.

### NOTE

- Use this feature only when the oven has cooled completely to room temperature.
- DO NOT use distilled water.

# Operations

- DO NOT use high-pressure water cleaners or steam jet cleaners to clean the microwave oven.
- If the oven is hot inside, auto cleaning will not activate. Wait until the oven cools down, and then try again.
- Do not pour water onto the bottom by force. Do it gently. Otherwise, the water overflows to the front.

## Deodorisation

This function is useful for deodorizing the oven. Use this function regularly to remove any unpleasant odour in your oven.

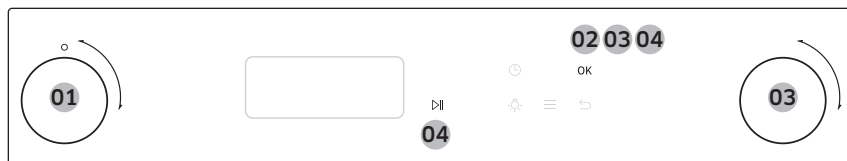

1. Use the **Mode Dial** to wake the control panel, and then select **Deodorisation** (☞).
2. Tap **OK** to confirm.
3. Turn the **Value Dial** to set time, and then tap **OK**. (Default set time is 5 minutes.)
4. When done, tap **OK** or **▶||** to start.

## More Functions

Menu	Description
Timer	You can set the timer.
Lock	You can lock the control panel.
My Modes	You can edit the cooking mode list.
Screen time out	You can adjust the display timeout.
Set time	You can set the current time. <b>NOTE</b> For detailed instruction, see page 13.
Set date	You can set the current date. <b>NOTE</b> For detailed instruction, see page 13.
Time format	You can set the time format to 12-hour or 24-hour format. <b>NOTE</b> For detailed instruction, see page 13.
Sound	You can turn the oven's sound (beeps) on or off.



### Timer

1. Tap **☰**, and then tap **OK**.
2. Select **Timer** using the **Value Dial**, and then tap **OK**.
3. Set the timer (hour and minute) using the **Value Dial**, and then tap **OK**.
4. Tap **OK** to start the timer.
5. If you want to pause, cancel, or edit timer, tap **OK** or turn the **Value Dial**.

### Lock

1. Tap **☰**, and then tap **OK**.
2. Select **Lock** using the **Value Dial**, and then tap **OK**.
3. If you want to unlock the control panel, tap and hold **☰** for 3 seconds.

## My Modes

1. Tap  and then tap **OK**.
2. Select **My Modes** using the **Value Dial**, and then tap **OK**.
3. Turn the **Value Dial**, and then tap **OK** to select or unselect modes.
4. Tap  or  to save.
5. Select **Save** to save the changes.

## Screen time out

1. Tap  and then tap **OK**.
2. Select **Screen time out** using the **Value Dial**, and then tap **OK**.
3. Turn the **Value Dial** to select the desired time.
4. Tap **OK** to save the changes.

## Sound

1. Tap  and then tap **OK**.
2. Select **Sound** using the **Value Dial**, and then tap **OK**.
3. Turn the **Value Dial** to select **On** or **Off**.
4. Tap **OK** to save the changes.

## System Settings

Tap and hold  for 3 seconds to enter the **System Settings** menu, and then turn the **Value Dial** to change various settings for your oven.

Please refer to the following table for detailed descriptions.

System Setting	Description
Wi-Fi	You can turn the Wi-Fi on or off.
Language	You can select a language.
My Patterns	This function remembers and stores the cook settings.
Demo Mode	Used by retailers for display purposes only.
Reset	Reset your setting. (More Functions, System settings)

## Wi-Fi / My Patterns / Demo Mode

1. Tap and hold  for 3 seconds to enter the **System Settings** menu, and then tap **OK**.
2. Select the desired menu using the **Value Dial**, and then tap **OK**.
3. Turn the **Value Dial** to select **On** or **Off**.
4. Tap **OK** to save the changes.

## Language

1. Tap and hold  for 3 seconds to enter the **System Settings** menu, and then tap **OK**.
2. Select **Language** using the **Value Dial**, and then tap **OK**.
3. Turn the **Value Dial** to select the desired language.
4. Tap **OK** to save the changes.

## Reset

1. Tap and hold  for 3 seconds to enter the **System Settings** menu, and then tap **OK**.
2. Select **Reset** using the **Value Dial**, and then tap **OK**.
3. Turn the **Value Dial** to select **Reset** or **Cancel**.
4. Tap **OK** to confirm.

## AP Easy Setup

To use the oven's monitoring, you must download the SmartThings app to a mobile device. Functions operated by the SmartThings app may not work smoothly if communication conditions are poor or the oven is installed in a place with a weak Wi-Fi signal.

For safety reason, remote control function is not available for microwave mode.

## How to connect the microwave oven

1. Download and open the SmartThings app on your mobile device.
2. Follow the app's on-screen instructions to connect your oven.
3. Tap  for 3 seconds to connect with Wi-Fi device.

# Cooking Smart

## Manual cooking

### Microwave cooking guide

#### General guidelines

##### Food suitable for microwave cooking

Many kinds of food are suitable for microwave cooking, including fresh or frozen vegetables, fruit, pasta, rice, grains, beans, fish, and meat. Sauces, custard, soups, steamed puddings, preserves, and chutneys can also be cooked in a microwave oven.

##### Covering during cooking

Food should be covered during cooking, as the evaporated water rises as steam and contributes to the cooking process. Food can be covered in different ways such as with a ceramic plate, plastic cover or microwave suitable cling film.

##### Standing times

After cooking, it is important to let food stand for the recommended standing time to allow the temperature to even out within the food.

##### Cooking guide for frozen vegetables

Use a suitable glass Pyrex bowl with lid. Cook covered for the minimum time (see table).

Continue cooking to get the result you prefer. Stir twice during cooking and once after cooking. Add salt, herbs or butter after cooking. Keep covered during standing time.

Food	Portion (g)	Power (W)	Time (min.)	Standing time (min.)	Instructions
Spinach	150	600	5-6	2-3	Add 15 ml (1 tbsp.) cold water.
Broccoli	300	600	8-9	2-3	Add 30 ml (2 tbsp.) cold water.
Peas	300	600	7-8	2-3	Add 15 ml (1 tbsp.) cold water.

Food	Portion (g)	Power (W)	Time (min.)	Standing time (min.)	Instructions
Green Beans	300	600	7½-8½	2-3	Add 30 ml (2 tbsp.) cold water.
Mixed Vegetables (Carrots/Peas/Corn)	300	600	7-8	2-3	Add 15 ml (1 tbsp.) cold water.
Mixed Vegetables (Chinese Style)	300	600	7½-8½	2-3	Add 15 ml (1 tbsp.) cold water.

##### Cooking guide for fresh vegetables

Use a suitable glass Pyrex bowl with lid. Add 30-45 ml cold water (2-3 tbsp.) for every 250 g unless another water quantity is recommended (see table) Cook covered for the minimum time (see table) Continue cooking to get the result you prefer. Stir once during and after cooking. Add salt, herbs or butter after cooking. Cover during the 3 minute standing time.

**Hint:** Cut fresh vegetables into even sized pieces. The smaller they are cut the quicker they are cooked.

All fresh vegetables should be cooked using full microwave power (900 W).

Food	Portion (g)	Time (min.)	Standing time (min.)	Instructions
Broccoli	250 500	4-5 5-6	3	Prepare even sized florets. Arrange the stems to the center.
Brussels Sprouts	250	5-6	3	Add 60-75 ml (5-6 tbsp.) water.
Carrots	250	5-6	3	Cut carrots into even sized slices.
Cauliflower	250 500	5-6 7-8	3	Prepare even sized florets. Cut big florets into halves. Arrange stems to the center.

Food	Portion (g)	Time (min.)	Standing time (min.)	Instructions
Courgettes	250	3-4	3	Cut courgettes into slices. Add 30 ml (2 tbsp.) water or a knob of butter. Cook until just tender.
Egg Plants	250	3-4	3	Cut egg plants into small slices and sprinkle with 1 tablespoon lemon juice.
Leeks	250	3-4	3	Cut leeks into thick slices.
Mushrooms	125 250	1-2 2-3	3	Prepare small whole or sliced mushrooms. Do not add any water. Sprinkle with lemon juice. Spice with salt and pepper. Drain before serving.
Onions	250	4-5	3	Cut onions into slices or halves. Add only 15 ml (1 tbsp.) water.
Pepper	250	4-5	3	Cut pepper into small slices.
Potatoes	250 500	4-5 7-8	3	Weigh the peeled potatoes and cut them into similar sized halves or quarters.
Turnip Cabbage	250	5-6	3	Cut turnip cabbage into small cubes.

### Cooking guide for rice and pasta

**Rice:** Use a large glass Pyrex bowl with lid. (Note that rice doubles in volume during cooking.) Cook covered. After cooking time is over, stir before letting stand. Add salt or herbs and butter. Note that rice may not have absorbed all water after the cooking time is finished.

**Pasta:** Use a large glass pyrex bowl. Add boiling water, a pinch of salt and stir well. Cook uncovered. Stir occasionally during and after cooking. Cover during standing time and drain thoroughly afterwards.

Food	Portion (g)	Power (W)	Time (min.)	Standing time (min.)	Instructions
White Rice (Parboiled)	250 375	900	17-18 18-20	5	Add 500 ml cold water. Add 750 ml cold water.
Brown Rice (Parboiled)	250 375	900	20-22 22-24	5	Add 500 ml cold water. Add 750 ml cold water.
Mixed Rice (Nice + Wild Rice)	250	900	17-19	5	Add 500 ml cold water.
Mixed Corn (Rice + Grain)	250	900	18-20	5	Add 400 ml cold water.
Pasta	250	900	10-11	5	Add 1000 ml hot water.

# Cooking Smart

## Reheating

Your microwave oven will reheat food in a fraction of the time a conventional oven takes.

## Arranging and covering

Avoid reheating large items such as joints of meat since they tend to overcook and dry out before the centre is piping hot. You will have more success reheating smaller pieces. Keeping food covered while heating will also help prevent drying.

## Power levels

Different power levels can be used for reheating foods. In general, for large quantities of delicate food or foods that heat up quickly, such as mince pies, it is better to use a lower power level.

## Stirring

Stir well or turn food over during reheating for best results. When possible, stir again before serving. Stirring is especially important when heating liquids.

## Heating and standing times

When reheating food for the first time, it is helpful to make a note of the time taken for future reference. Avoid overheating. If uncertain, it is preferable to underestimate cooking time. Then extra heating time can be added, if necessary. Always make sure that reheated food is piping hot throughout. Allow food to stand for a short time after reheating to let the temperature even out. The recommended standing time after reheating is 2-4 minutes.

## Reheating liquids

Take special care when heating liquids. To prevent eruptive boiling and possible scalding, place a spoon or glass stick in the beverage. Stir during heating and always stir after heating. Allow a standing time of at least 20 seconds after the oven has been switched off to allow the temperature to even out.

## Reheating baby food

### Baby food

Extra caution should also be exercised when reheating baby foods. Put food into a deep ceramic plate. Cover with plastic lid. Stir well after reheating. Let stand for 2-3 minutes before serving. Stir again and check temperature. Recommended serving temperature is between 30-40 °C.

### Baby milk

Pour milk into a sterilised glass bottle. Reheat uncovered. Never heat a baby's bottle with the nipple on, as the bottle may explode if overheated. Shake well before standing time and again before serving. Always carefully check the temperature of baby milk or food before serving. Recommended serving temperature is 37 °C.

## Reheating baby food and milk

Use the power levels and times in this table as guide lines for reheating.

Food	Portion	Power	Time	Standing time (min.)	Instruction
Baby Food (Vegetable + Meat)	190 g	600 W	30-40 sec.	2-3	Empty into ceramic deep plate. Cook covered. Stir after cooking time. Stand for 2-3 minutes. Before serving, stir well and check the temperature carefully.

Food	Portion	Power	Time	Standing time (min.)	Instruction
Baby Porridge (Grain + Milk + Fruit)	190 g	600 W	20-30 sec.	2-3	Empty into ceramic deep plate. Cook covered. Stir after cooking time. Stand for 2-3 minutes. Before serving, stir well and check the temperature carefully.
Baby Milk	100 ml 200 ml	300 W	30-40 sec. 50 sec. to 1 min.	2-3	Stir or Shake well and pour into a sterilized glass bottle. Place into the centre of ceramic tray. Cook uncovered. Shake well and stand for at least 3 minutes. Before serving, Shake well and check the temperature carefully.

### Reheating liquids and food

Use the power levels and times in this table as guide lines for reheating.

Food	Portion	Power	Time	Standing time (min.)	Instruction
Drink	250 ml (1 mug) 500 ml (2 mugs)	900 W	1½-2 2-3	1-2	Pour into a ceramic cup and reheat uncovered. Place cup in the center of ceramic tray. Stir carefully before and after standing time.
Soup (Chilled)	250 g	900 W	3-4	2-3	Pour into a deep ceramic plate. Cover with plastic lid. Stir well after reheating. Stir again before serving.
Stew (Chilled)	350 g	600 W	5-6	2-3	Pour into a deep ceramic plate. Cover with plastic lid. Stir well after reheating. Stir again before serving.
Pasta with sauce (Chilled)	350 g	600 W	5-6	2-3	Pour into a deep ceramic plate. Cover with plastic lid. Stir well after reheating. Stir again before serving.
Plated meal (Chilled)	350 g 450 g	600 W	5-6 6-7	3	Plate a meal of 2-3 chilled components on a ceramic dish. Cover with microwave cling film.

# Cooking Smart

## Defrosting

Microwaves are an excellent way of defrosting frozen food. Microwaves gently defrost frozen food in a short period of time. This can be a great advantage, if unexpected guests suddenly show up.

Frozen poultry must be thoroughly thawed before cooking. Remove any metal ties and take it out of any wrapping to allow thawed liquid to drain away.

Put the frozen food on a dish without a cover. Turn over half way, drain off any liquid and remove any giblets as soon as possible. Check the food occasionally to make sure that it does not feel warm. If smaller and thinner parts of the frozen food start to warm up, they can be shield by wrapping very small strips of aluminium foil around them during defrosting.

Should poultry start to warm up on the outer surface, press **STOP** and allow it to stand for 20 minutes before continuing. Leave the fish, meat and poultry to stand in order to complete defrosting. The standing time for complete defrosting will vary depending on the quantity defrosted. Please refer to the table on the next page.

**Hint:** Flat food is defrosted better than thicker items, and smaller quantities need less time than bigger ones. Remember this hint while freezing and defrosting food.

For defrosting of frozen food with a temperature of about -18 to -20 °C, use the following table as a guide.

Frozen foods should be defrosted using defrosting power level (180 W).

Place food on ceramic tray, insert ceramic tray in shelf level 1.

Food	Portion (g)	Time (min.)	Standing time (min.)	Instructions
<b>MEAT</b>				
Minced Beef	250	6-7	15-30	Place the meat on the ceramic plate. Shield thinner edges with aluminium foil. Turn over after half of defrosting time.
	500	8-12		
Pork Steaks	250	7-8		
<b>POULTRY</b>				
Chicken Pieces	500 (2 pcs)	12-14	15-60	First, put chicken pieces skin - side down, whole chicken breast - side - down on ceramic plate. Shield the thinner parts like wings and ends with aluminium foil. Turn over after half of defrosting time.
Whole Chicken	1200	28-32		
<b>FISH</b>				
Fish Fillets	200	6-7	10-25	Put frozen fish in the middle of ceramic plate. Arrange the thinner parts under the thicker parts. Shield narrow ends of fillets and tail of whole fish With aluminium foil. Turn over after half of defrosting time.
Whole Fish	400	11-13		
<b>FRUIT</b>				
Berries	300	6-7	5-10	Spread fruit on a flat, round glass dish with a large diameter.
<b>BREAD</b>				

Food	Portion (g)	Time (min.)	Standing time (min.)	Instructions
Bread Rolls (each ca. 50 g)	2 pcs 4 pcs	1-1½ 2½-3	5-20	Arrange rolls in a circle or bread horizontally on kitchen paper on the ceramic plate. Turn over after half of defrosting time.
Toast/ Sandwich	250 500	4-4½ 7-9		

## Quick & Easy

### Melting butter

Put 50 g butter into a small deep glass dish. Cover with plastic lid. Heat for 30-40 seconds using 800 W, until butter is melted.

### Melting chocolate

Put 100 g chocolate into a small deep glass dish. Heat for 3-5 minutes, using 450 W until chocolate is melted. Stir once or twice during melting. Use oven gloves while taking out!

### Melting crystallized honey

Put 20 g crystallized honey into a small deep glass dish. Heat for 20-30 seconds using 300 W, until honey is melted.

### Melting gelatine

Lay dry gelatine sheets (10 g) for 5 minutes into cold water. Put drained gelatine into a small glass pyrex bowl. Heat for 1 minute using 300 W. Stir after melting.

### Cooking glaze/icing (for cake and gateaux)

Mix instant glaze (approximately 14 g) with 40 g sugar and 250 ml cold water. Cook uncovered in a glass pyrex bowl for 3½ to 4½ minutes using 800 W, until glaze/icing is transparent. Stir twice during cooking.

### Cooking jam

Put 600 g fruits (for example mixed berries) in a suitable sized glass pyrex bowl with lid. Add 300 g preserving sugar and stir well. Cook covered for 10-12 minutes using 800 W. Stir several times during cooking. Put directly into small jam glasses with twist-off lids. Stand on lid for 5 minutes.

### Cooking pudding

Mix pudding powder with sugar and milk (500 ml) by following the manufacturers instructions and stir well. Use a suitable sized glass pyrex bowl with lid. Cook covered for 6½ to 7½ minutes using 800 W. Stir several times well during cooking.

### Browning almond slices

Spread 30 g sliced almonds evenly on a medium sized ceramic plate. Stir several times during browning for 3½ to 4½ minutes using 600 W. Let it stand for 2-3 minutes in the oven. Use oven gloves while taking out!

# Troubleshooting

You may encounter a problem using the oven. In that case, first check the table below and try the suggestions. If a problem persists, or if any information code keeps appearing on the display, contact a local Samsung service centre.

## Checkpoints

If you encounter a problem with the oven, first check the table below and try the suggestions.

Problem	Cause	Action
<b>General</b>		
The buttons cannot be pressed properly.	Foreign matter may be caught between the buttons.	Remove the foreign matter and try again.
	For touch models: Moisture is on the exterior.	Wipe the moisture from the exterior.
	Child lock is activated.	Deactivate Child lock.
The time is not displayed.	Power is not supplied.	Make sure power is supplied.
	The Eco (power-saving) function is set.	Turn off the Eco function.
The oven does not work.	Power is not supplied.	Make sure power is supplied.
	The door is open.	Close the door and try again.
	The door open safety mechanisms are covered in foreign matter.	Remove the foreign matter and try again.
The oven stops while in operation.	The user has opened the door to turn food over.	After turning over the food, press the  button again to start operation.

Problem	Cause	Action
The power turns off during operation.	The oven has been cooking for an extended period of time.	After cooking for an extended period of time, let the oven cool.
	The cooling fan is not working.	Listen for the sound of the cooling fan.
	Trying to operate the oven without food inside.	Put food in the oven.
	There is not sufficient ventilation space for the oven.	There are intake/exhaust outlets on the front and rear of the oven for ventilation. Keep the gaps specified in the product installation guide.
There is no power to the oven.	Several power plugs are being used in the same socket.	Designate only one socket to be used for the oven.
	Power is not supplied.	Make sure power is supplied.
There is a popping sound during operation, and the oven doesn't work.	Cooking sealed food or using a container with a lid may causes popping sounds.	Do not use sealed containers as they may burst during cooking due to expansion of the contents.

Problem	Cause	Action
The oven exterior is too hot during operation.	There is not sufficient ventilation space for the oven.	There are intake/exhaust outlets on the front and rear of the oven for ventilation. Keep the gaps specified in the product installation guide.
	Objects are on top of the oven.	Remove all objects on the top of the oven.
The door cannot be opened properly.	Food residue is stuck between the door and oven interior.	Clean the oven and then open the door.
The oven does not heat.	The oven may not work, too much food is being cooked, or improper cookware is being used.	Put one cup of water in a microwave-safe container and run the microwave for 1-2 minutes to check whether the water is heated. Reduce the amount of food and start the function again. Use a cooking container with a flat bottom.

Problem	Cause	Action
Heating is weak or slow.	The oven may not work, too much food is being cooked, or improper cookware is being used.	Put one cup of water in a microwave-safe container and run the microwave for 1-2 minutes to check whether the water is heated. Reduce the amount of food and start the function again. Use a cooking container with a flat bottom.
The warm function does not work.	The oven may not work, too much food is being cooked, or improper cookware is being used.	Put one cup of water in a microwave-safe container and run the microwave for 1-2 minutes to check whether the water is heated. Reduce the amount of food and start the function again. Use a cooking container with a flat bottom.

# Troubleshooting

Problem	Cause	Action
The thaw function does not work.	The oven may not work, too much food is being cooked, or improper cookware is being used.	Put one cup of water in a microwave-safe container and run the microwave for 1-2 minutes to check whether the water is heated. Reduce the amount of food and start the function again. Use a cooking container with a flat bottom.
The interior light is dim or does not turn on.	The door has been left open for a long time.	The interior light may automatically turn off when the Eco function operates. Close and reopen the door or press the "Cancel" button.
	The interior light is covered by foreign matter.	Clean the inside of the oven and check again.
A beeping sound occurs during cooking.	If the Auto Cook function is being used, this beeping sound means it's time to turn over the food during thawing.	After turning over the food, press the Start button again to restart operation.
The oven is not level.	The oven is installed on an uneven surface.	Make sure the oven is installed on flat, stable surface.

Problem	Cause	Action
There are sparks during cooking.	Metal containers are used during the oven/thawing functions.	Do not use metal containers.
When power is connected, the oven immediately starts to work.	The door is not properly closed.	Close the door and check again.
There is electricity coming from the oven.	The power or power socket is not properly grounded.	Make sure the power and power socket are properly grounded.
There is water dripping.	There may be water or steam in some cases depending on the food. This is not an oven malfunction.	Let the oven cool and then wipe with a dry dish towel.
Steam leaks from the door.	There may be water or steam in some cases depending on the food. This is not an oven malfunction.	Let the oven cool and then wipe with a dry dish towel.
There is water left in the oven.	There may be water or steam in some cases depending on the food. This is not an oven malfunction.	Let the oven cool and then wipe with a dry dish towel.
The brightness inside the oven varies.	Brightness changes depending on power output changes according to function.	Power output changes during cooking are not malfunctions. This is not an oven malfunction.

Problem	Cause	Action
Cooking is finished, but the cooling fan is still running.	To ventilate the oven, the cooling fan continues to run for about 5 minutes after cooking is complete.	This is not an oven malfunction.
Pressing the +30 secs button operates the oven.	This happens when the oven was not operating.	The microwave oven is designed to operate by pressing the +30 secs button when it was not operating.
<b>Turntable</b>		
While turning, the turntable comes out of place or stops turning.	There is no roller ring, or the roller ring is not properly in place.	Install the roller ring and then try again.
The turn table drags while turning.	The roller ring is not properly in place, there is too much food, or the container is too large and touches the inside of the microwave.	Adjust the amount of food and do not use containers that are too large.
The turn table rattles while turning and is noisy.	Food residue is stuck to the bottom of the oven.	Remove any food residue stuck to the bottom of the oven.

Problem	Cause	Action
<b>Grill</b>		
Smoke comes out during operation.	During initial operation, smoke may come from the heating elements when you first use the oven.	This is not a malfunction, and if you run the oven 2-3 times, it should stop.
	Food is on the heating elements.	Let the oven cool and then remove the food from the heating elements.
	Food is too close to the grill.	Put the food a suitable distance away while cooking.
	Food is not properly prepared and/or arranged.	Make sure food is properly prepared and arranged.
<b>Oven</b>		
The oven does not heat.	The door is open.	Close the door and try again.
Smoke comes out during preheating.	During initial operation, smoke may come from the heating elements when you first use the oven.	This is not a malfunction, and if you run the oven 2-3 times, it should stop.
	Food is on the heating elements.	Let the oven cool and then remove the food from the heating elements.
There is a burning or plastic smell when using the oven.	Plastic or non heat-resistant cookware is used.	Use glass cookware suitable for high temperatures.

# Troubleshooting

Problem	Cause	Action
There is a bad smell coming from inside the oven.	Food residue or plastic has melted and stuck to the interior.	Use the steam function and then wipe with a dry cloth. You can put a lemon slice inside and run the oven to remove the odour more quickly.
The oven does not cook properly.	The oven door is frequently opened during cooking.	Do not frequently open the door unless you are cooking things that need to be turned. If you open the door often, the interior temperature will be lowered and this may affect the results of your cooking.
	The oven controls are not correctly set.	Correctly set the oven controls and try again.
	The grill or other accessories are not correctly inserted.	Correctly insert the accessories.
	The wrong type or size of cookware is used.	Reset the oven controls or use suitable cookware with flat bottoms.

## Information codes

If the oven fails to operate, you may see an information code on the display. Check the table below and try the suggestions.

Code	Description	Action
C-F0	If there is no communication between the main and sub MICOM.	Unplug the power cord of the oven, and contact a local Samsung service centre.
C-F1	Only occurs when EEPROM Read or Write is not working.	
C-F2	The touch key is malfunction.	Press ▷   to try again.
C-d0		Unplug the power cord for cooling enough time, and clean the button. (Dust, Water) When appear same problem, contact a local Samsung service centre.

## Technical specifications

SAMSUNG strives to improve its products at all times. Both the design specifications and these user instructions are thus subject to change without notice.

Power Source		230 V ~ 50 Hz
Power Consumption	Microwave	1650 W
Output Power		100 W / 900 W (IEC - 705)
Operating Frequency		2450 MHz
Magnetron		OM75P (21)
Cooling Method		Cooling fan motor
Dimensions (W x H x D)	Main unit	595 x 456 x 570 mm
	Built-in	560 x 446 x 549 mm
Volume		50 liter
Weight	Net	33.5 kg
	Shipping	39.0 kg

Overall Standby Power consumption (W) (All network ports is "on" condition)		1.9 W
Period of time for the power management (min)		20 min.
WiFi	Standby-mode Power Consumption (W)	1.9 W
	Period of time for the power management (min)	20 min.
Off mode	Power consumption	0.5 W
	Period of time for the power management (min)	20 min.

Data determined according to standard EN 50564 and Regulation (EC) No 1275/2008.

### NOTE

Hereby, Samsung declares that this radio equipment is in compliance with Directive 2014/53/EU and with the relevant statutory requirements in the UK. The full text of the EU declaration of conformity and the UK declaration of conformity is available at the following internet address: The official Declaration of conformity may be found at <http://www.samsung.com>. go to Support > Search Product Support and enter the model name.

# Appendix

---

## Open Source Announcement

---

The software included in this product contains open source software.  
The following URL [http://opensource.samsung.com/opensource/SMART\\_TP2\\_0/seq/0](http://opensource.samsung.com/opensource/SMART_TP2_0/seq/0) leads to open source license information as related to this product.



# Memo

---

# Memo

---

# Memo

---

Please be advised that the Samsung warranty does NOT cover service calls to explain product operation, correct improper installation, or perform normal cleaning or maintenance.

## QUESTIONS OR COMMENTS?

COUNTRY	CALL	OR VISIT US ONLINE AT
AUSTRIA	0800 72 67 864 (0800-SAMSUNG)	<a href="http://www.samsung.com/at/support">www.samsung.com/at/support</a>
BELGIUM	02-201-24-18	<a href="http://www.samsung.com/be/support">www.samsung.com/be/support</a> (Dutch) <a href="http://www.samsung.com/be_fr/support">www.samsung.com/be_fr/support</a> (French)
DENMARK	707 019 70	<a href="http://www.samsung.com/dk/support">www.samsung.com/dk/support</a>
FINLAND	030-6227 515	<a href="http://www.samsung.com/fi/support">www.samsung.com/fi/support</a>
FRANCE	01 48 63 00 00	<a href="http://www.samsung.com/fr/support">www.samsung.com/fr/support</a>
GERMANY	06196 77 555 77	<a href="http://www.samsung.com/de/support">www.samsung.com/de/support</a>
ITALIA	800-SAMSUNG (800.7267864)	<a href="http://www.samsung.com/it/support">www.samsung.com/it/support</a>
CYPRUS	8009 4000 only from landline, toll free	<a href="http://www.samsung.com/gr/support">www.samsung.com/gr/support</a>
GREECE	80111-SAMSUNG (80111 726 7864) only from land line (+30) 210 6897691 from mobile and land line	<a href="http://www.samsung.com/gr/support">www.samsung.com/gr/support</a>
LUXEMBURG	261 03 710	<a href="http://www.samsung.com/be_fr/support">www.samsung.com/be_fr/support</a>
NETHERLANDS	088 90 90 100	<a href="http://www.samsung.com/nl/support">www.samsung.com/nl/support</a>
NORWAY	21629099	<a href="http://www.samsung.com/no/support">www.samsung.com/no/support</a>
PORTUGAL	808 207 267	<a href="http://www.samsung.com/pt/support">www.samsung.com/pt/support</a>
SPAIN	91 175 00 15	<a href="http://www.samsung.com/es/support">www.samsung.com/es/support</a>
SWEDEN	0771 726 786	<a href="http://www.samsung.com/se/support">www.samsung.com/se/support</a>
SWITZERLAND	0800 726 786	<a href="http://www.samsung.com/ch/support">www.samsung.com/ch/support</a> (German) <a href="http://www.samsung.com/ch_fr/support">www.samsung.com/ch_fr/support</a> (French)
UK	0333 000 0333	<a href="http://www.samsung.com/uk/support">www.samsung.com/uk/support</a>
IRELAND (EIRE)	0818 717100	<a href="http://www.samsung.com/ie/support">www.samsung.com/ie/support</a>



DG68-01350A-00